



Model 92STSYS

## Steri-System Hospital Operating Room Air Distribution Systems

This is a complete operating room ventilation system, specially designed to reduce airborne contaminants. Model 92LS-SS Linear Slot Diffusers, located around the perimeter, create a continuous low velocity curtain of air angled outwards 5 – 15°. The curtain encloses the operating area and minimizes the possibility of contaminated air entering the surgical area. Model 92LFD-SS Laminar Flow Diffusers, installed above the operating table; produce a low velocity non-aspirating, vertical air pattern. This low velocity 'clean' conditioned air flows over the operating table and greatly increases the ventilation rate within the surgical area. The Steri-System is available in fourteen standard module sizes with a wide variety of custom variations that allow it to be tailored to suit almost any application or configuration.

**Stainless Steel – Model 92STSYS** See page E66  
 Suffix '-O' adds stainless steel perimeter inlet balancing dampers.



Models 67FB45 and 67FB55

## Return Air/Filter Grilles and Registers

The models in this series are stainless steel and designed to match and compliment the range of Hospital/Cleanroom supply diffusers. They are available with a variety of options including filter frames for 1" (25) or 2" (51) disposable filters, balancing dampers and 1/4 turn slot or wing nut fasteners.

**3/4" (19) Blade Spacing – Model 67FB45**

See page E86

**1/2" (13) Blade Spacing – Model 67FB55**

See page E92

Suffix '-O' adds a stainless steel OBD.

## STERI-SYSTEM

- HOSPITAL OPERATING ROOM AIR SYSTEM
- STAINLESS STEEL CONSTRUCTION

### Models:

**92STSYS    Stainless Steel**

- Suffix '-O' adds perimeter inlet balancing dampers



Model 92STSYS

The **Nailor Steri-System** is a complete operating room ventilation system specially designed to reduce airborne contaminants, and thus, the risk of patient infection during surgery. By using directed airflow, a protective 'clean zone' is created around the patient. The system consists of two main components.

**Model 92LS-SS Linear Slot Diffusers**, located around the perimeter, create a continuous curtain of air angled outwards 5 – 15°. The curtain encloses the operating area and minimizes the possibility of contaminated air entering the surgical area. The single slot design creates a uniform low velocity curtain that minimizes entrainment of contaminated air into the curtain air stream. It also creates a wider velocity profile with less turbulence and hence less induction over similar two slot designs. The face design incorporates longitudinal deflectors that horizontally deflect a small amount of air lengthwise. This effectively joins the airflow through sections and corners forming a truly continuous air curtain, resulting in enhanced isolation of the surgical area.

**Model 92LFD-SS Laminar Flow Diffusers**, installed above the operating table, produce a low velocity, non-aspirating, vertical air pattern. This 'clean' conditioned air flows over the operating table protecting the patient while greatly increasing the ventilation rate within the surgical area. The unique design incorporates a second pressure plate as an integral assembly to ensure true laminar airflow.

The Steri-System is available in fourteen standard module sizes with a wide variety of custom variations that allow it to be tailored to suit almost any application or configuration.

### FEATURES:

- All face plates and assemblies are removable for cleaning and are secured by 1/4 turn stainless steel fasteners.
- Safety cables are included as standard and prevent accidental dropping of the removable faces.
- Standard units are designed for both lay-in T-Bar ceiling systems and surface mount applications.

- Integral earthquake hanger tabs are standard.
- Laminar flow diffusers have integral dampers adjustable from the face of the diffuser.

### Material:

Type 304 Stainless Steel construction.

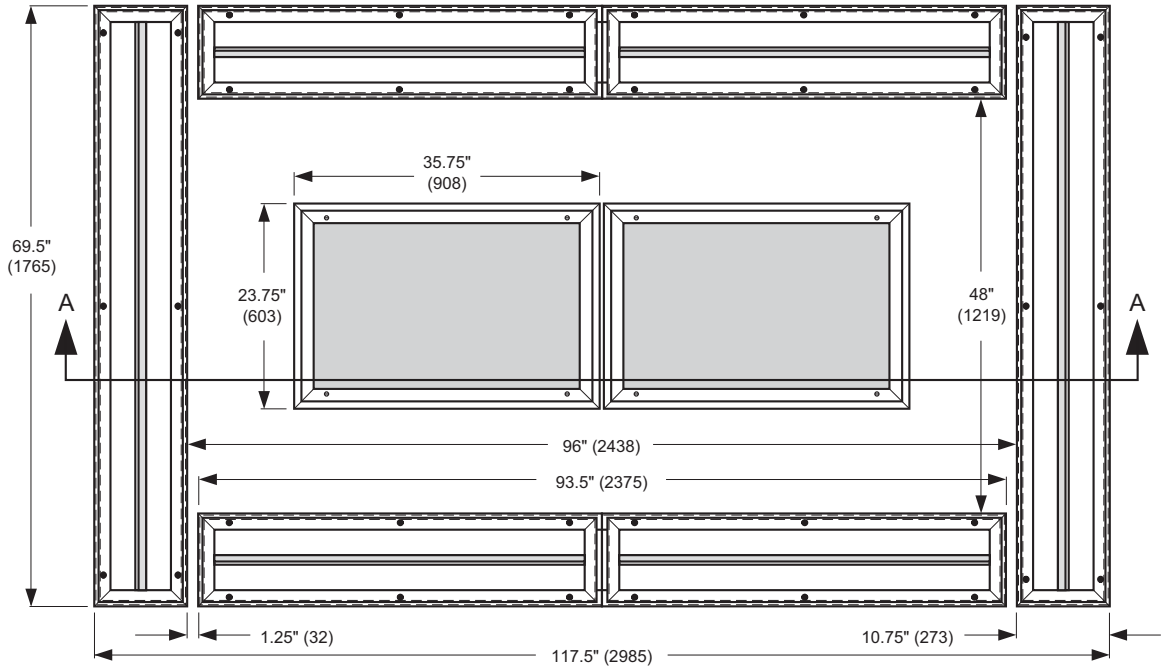
**Finish:** #3 Satin Polished finish is standard. Other finishes are available.

### Options:

- Perimeter Inlet Balancing Dampers (Face operated and removable).
- 316 Stainless Steel construction.

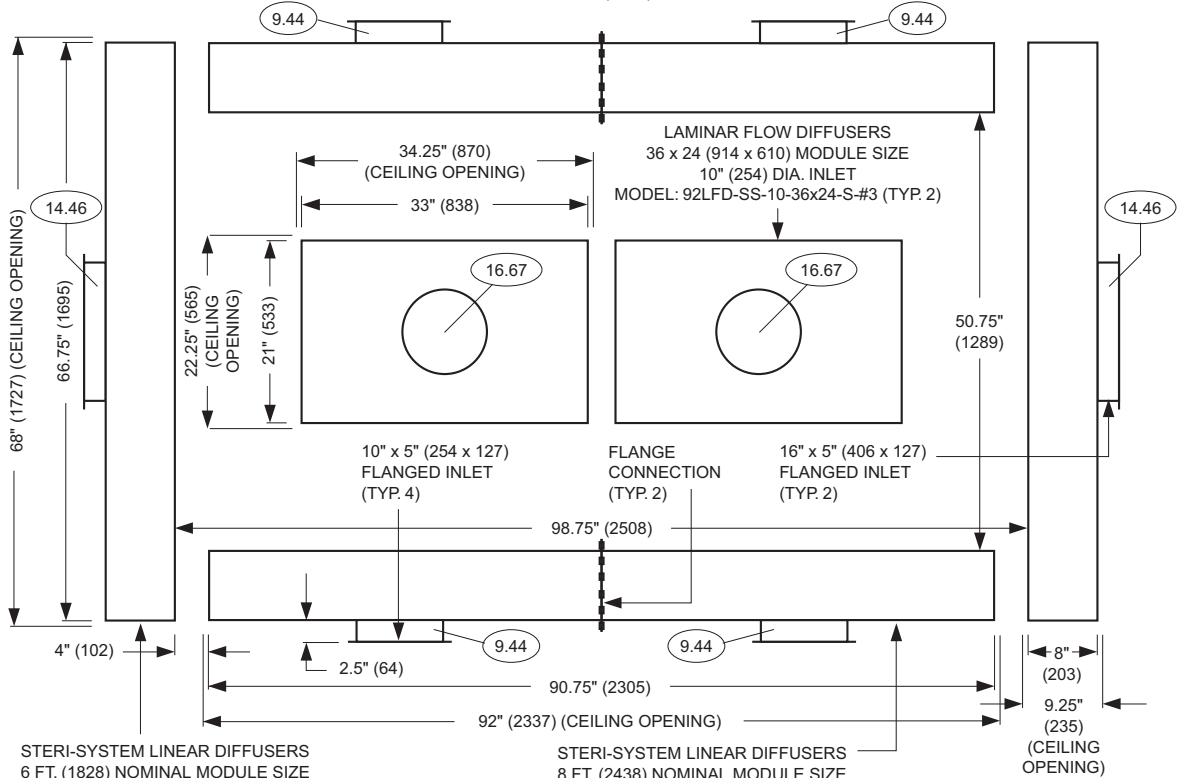
## Dimensional Data • Steri-System 8 x 4 Module • Model: 92STSYS – 8 x 4

Reflected Ceiling View

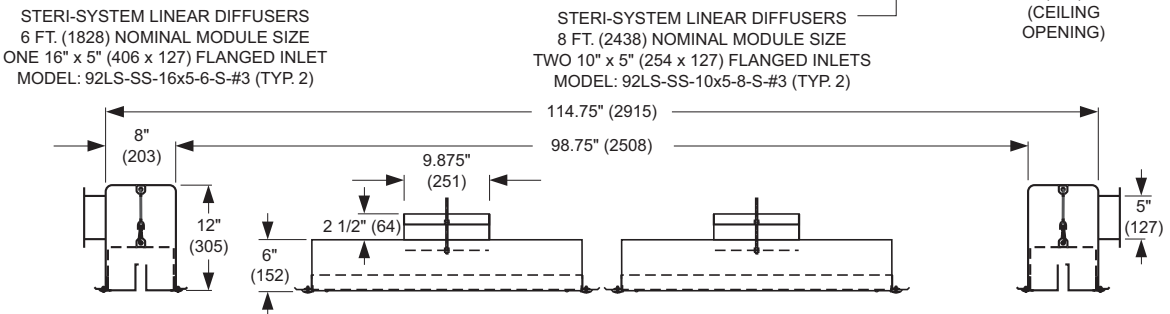


Plenum Top View

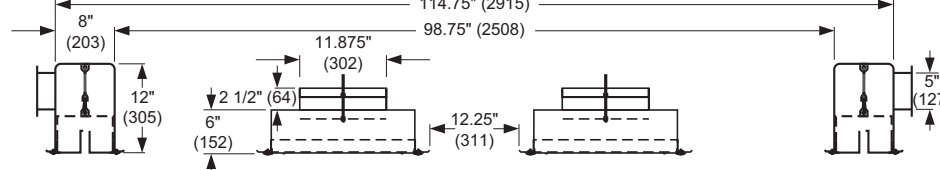
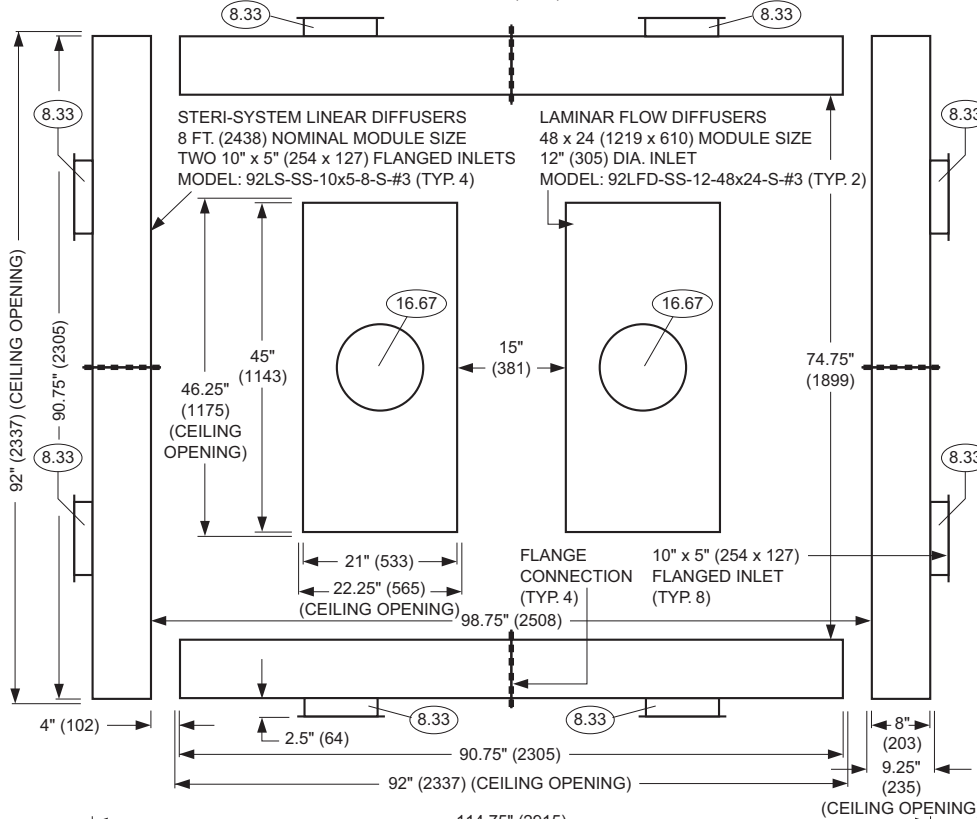
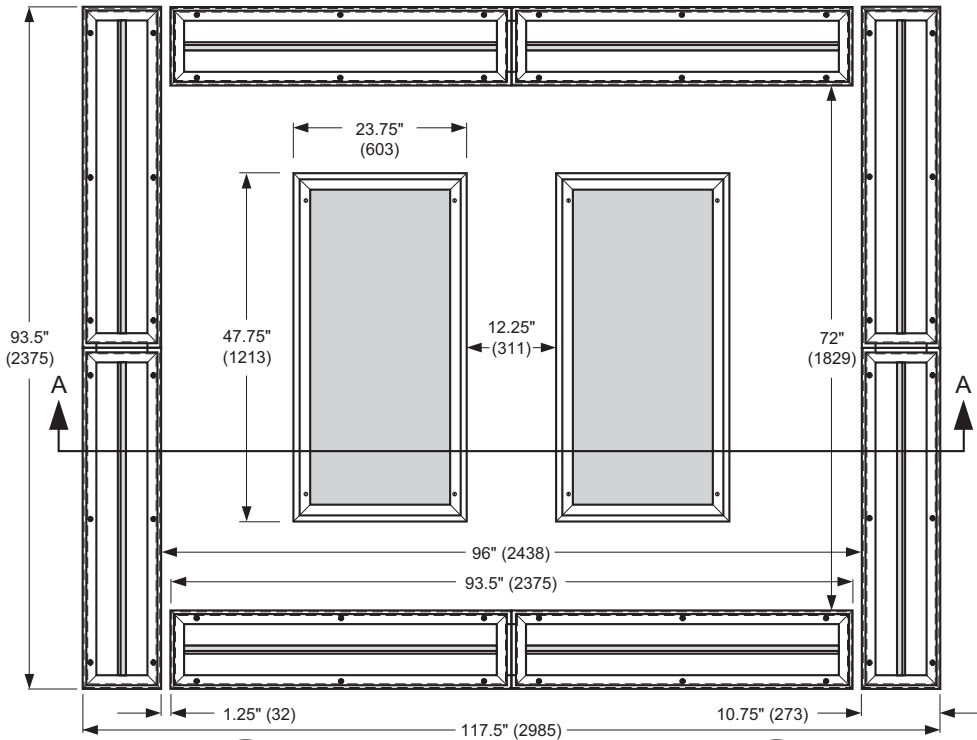
# = RECOMMENDED PERCENTAGE OF TOTAL SYSTEM AIRFLOW SUPPLIED THROUGH IDENTIFIED INLET.



Section Detail A – A



## Dimensional Data • Steri-System 8 x 6 Module • Model: 92STSYS – 8 x 6



# = RECOMMENDED PERCENTAGE OF TOTAL SYSTEM AIRFLOW SUPPLIED THROUGH IDENTIFIED INLET.

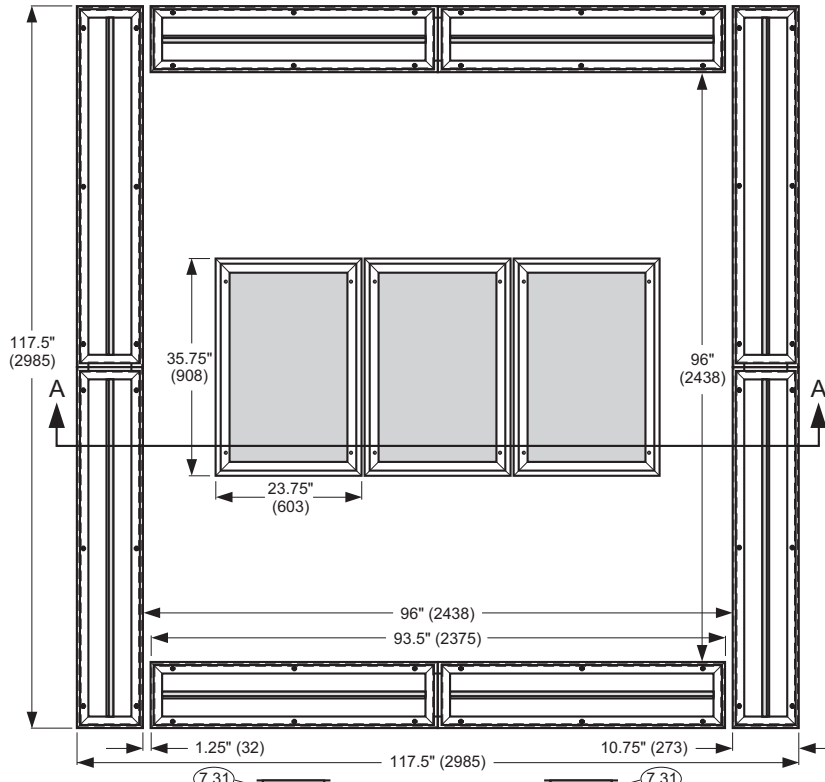
HOSPITAL / CLEANROOM DIFFUSERS  
Reflected Ceiling View

Plenum Top View

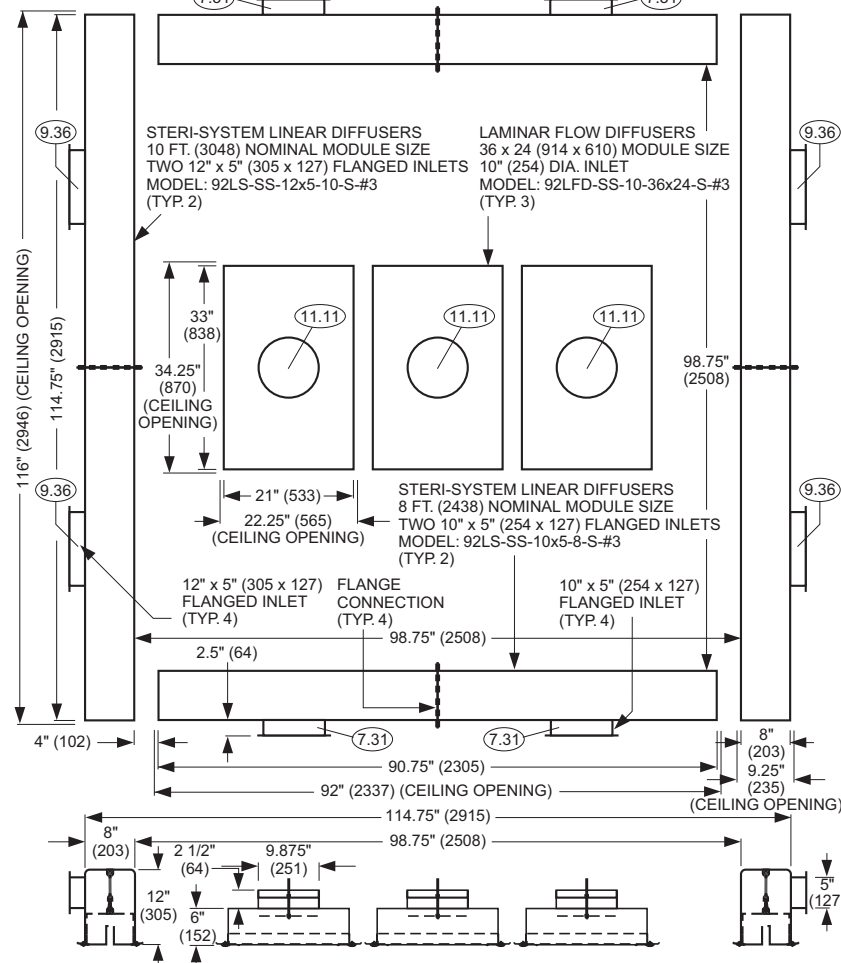
Section Detail A - A

## Dimensional Data • Steri-System 8 x 8 Module • Model: 92STSYS – 8 x 8

Reflected Ceiling View



Plenum Top View



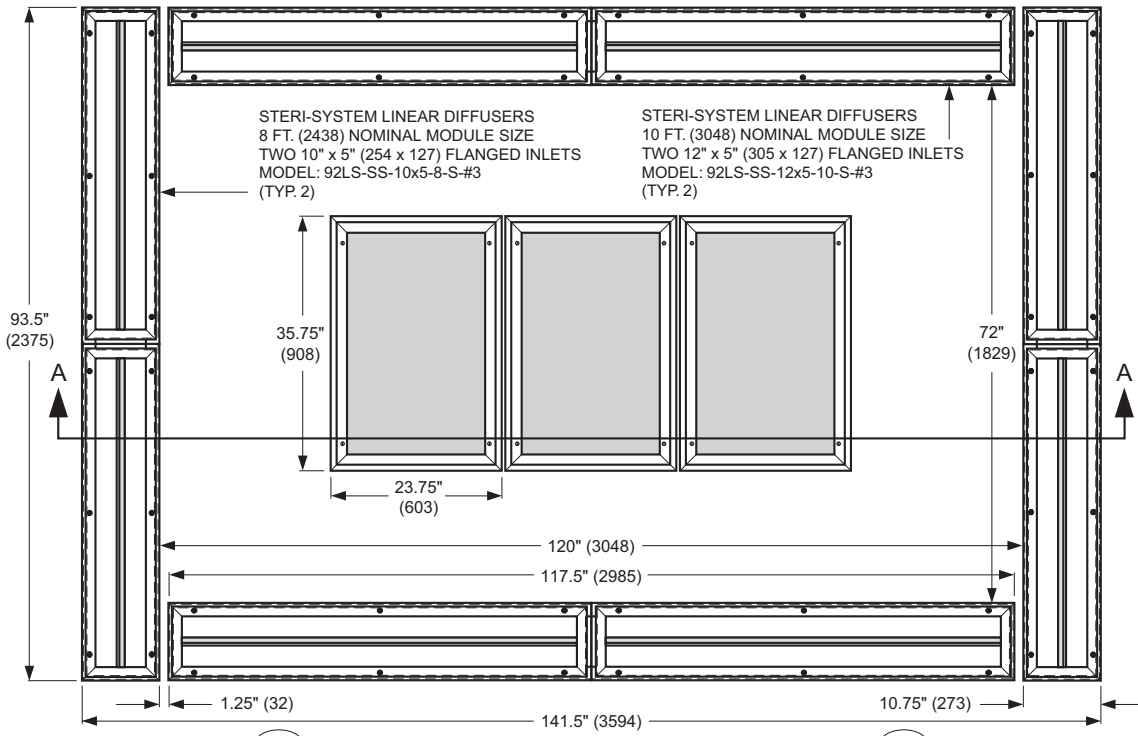
Section Detail A – A



HOSPITAL/CLEANROOM DIFFUSERS

## Dimensional Data • Steri-System 10 x 6 Module • Model: 92STSYS – 10 x 6

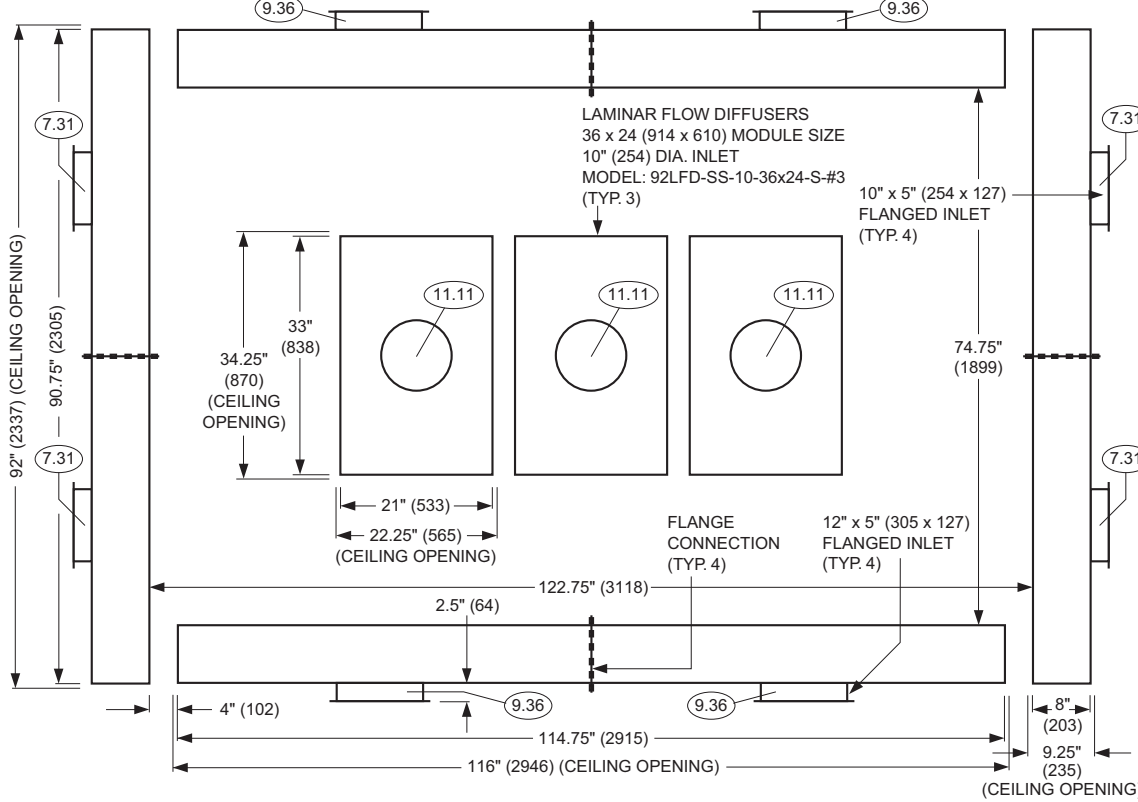
Reflected Ceiling View



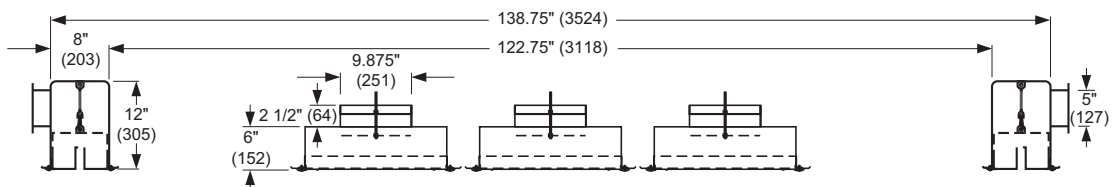
HOSPITAL/CLEANROOM DIFFUSERS

Plenum Top View

# = RECOMMENDED PERCENTAGE OF TOTAL SYSTEM AIRFLOW SUPPLIED THROUGH IDENTIFIED INLET.



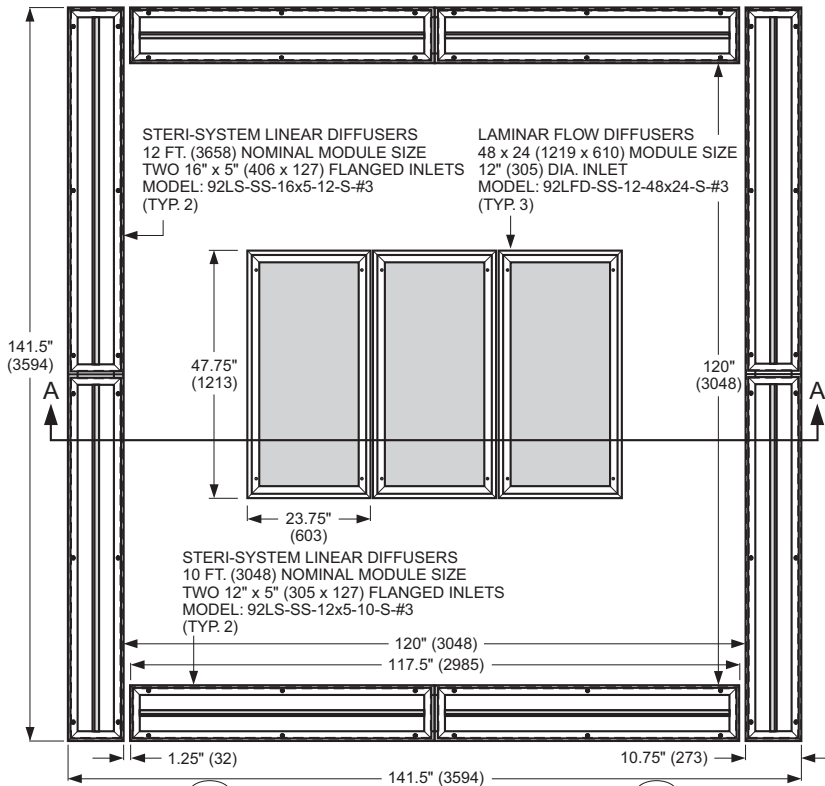
Section Detail A – A



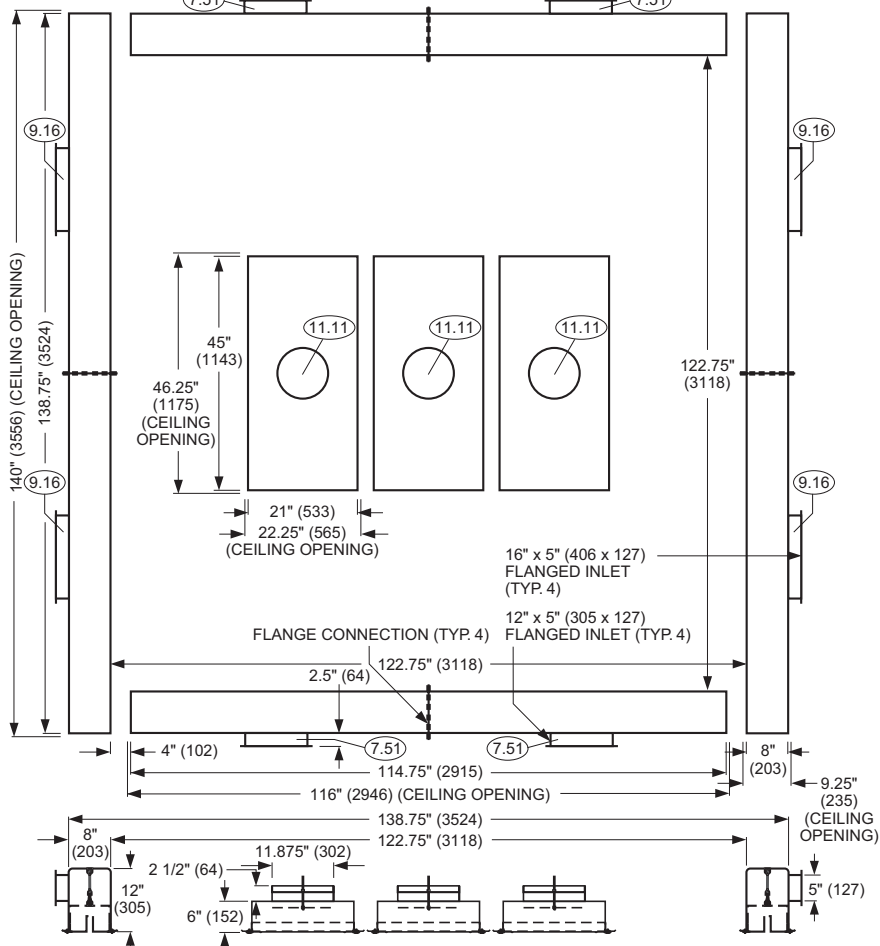




## Dimensional Data • Steri-System 10 x 10 Module • Model: 92STSYS – 10 x 10



Reflected Ceiling View

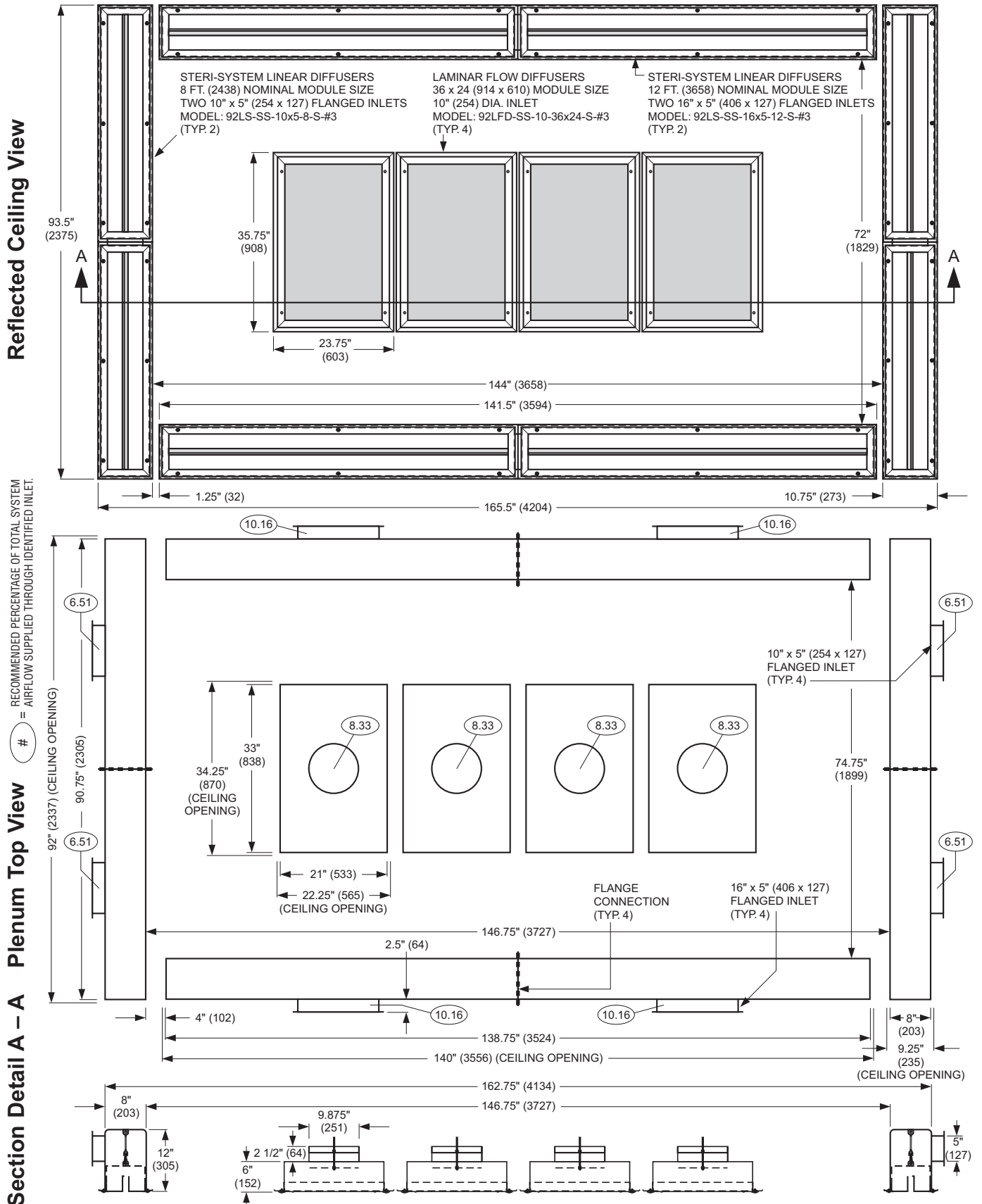


Plenum Top View

Section Detail A – A



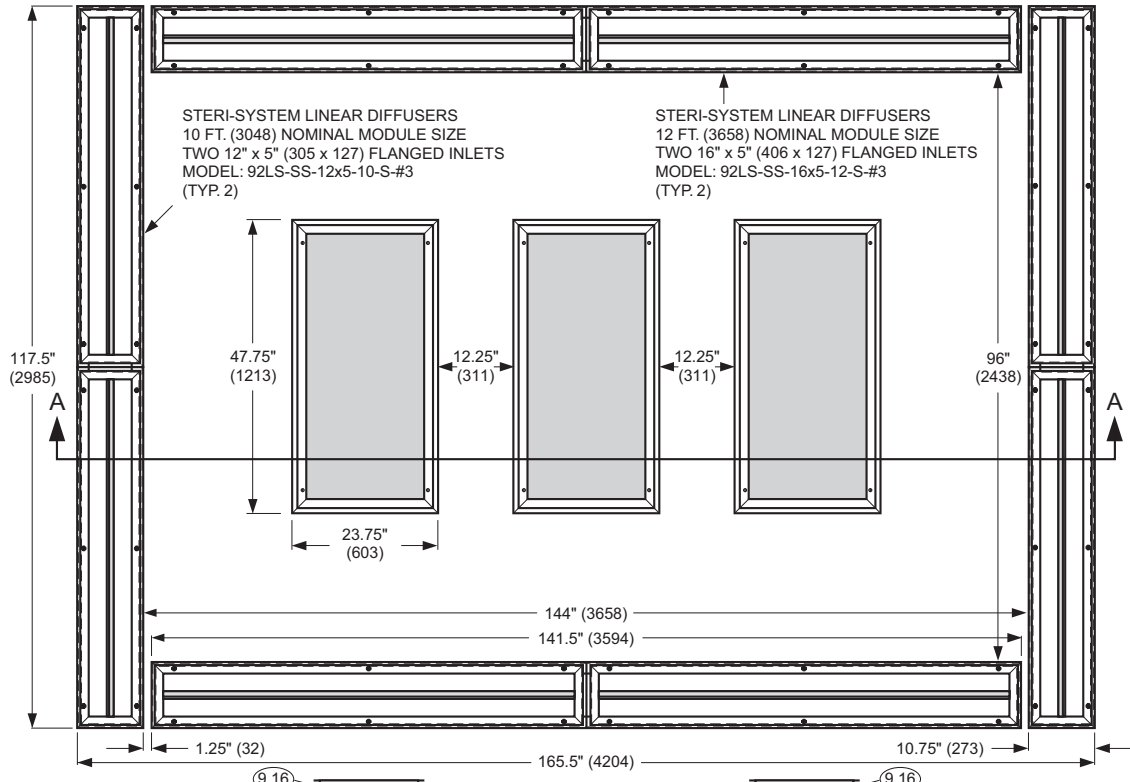
## Dimensional Data • Steri-System 12 x 6 Module • Model: 92STSYS – 12 x 6



## Dimensional Data • Steri-System 12 x 8 Module • Model: 92STSYS – 12 x 8

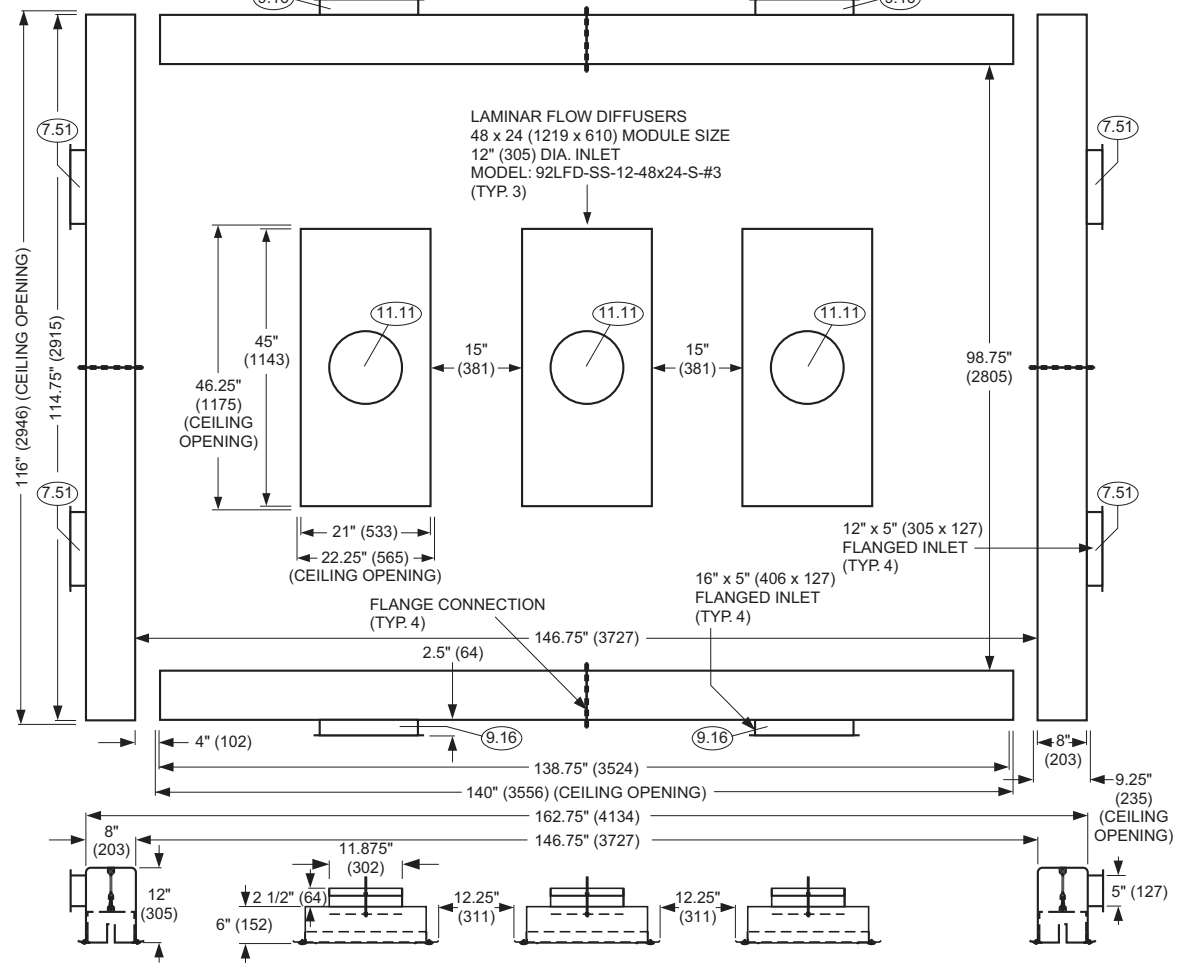
HOSPITAL/CLEANROOM DIFFUSERS

Reflected Ceiling View



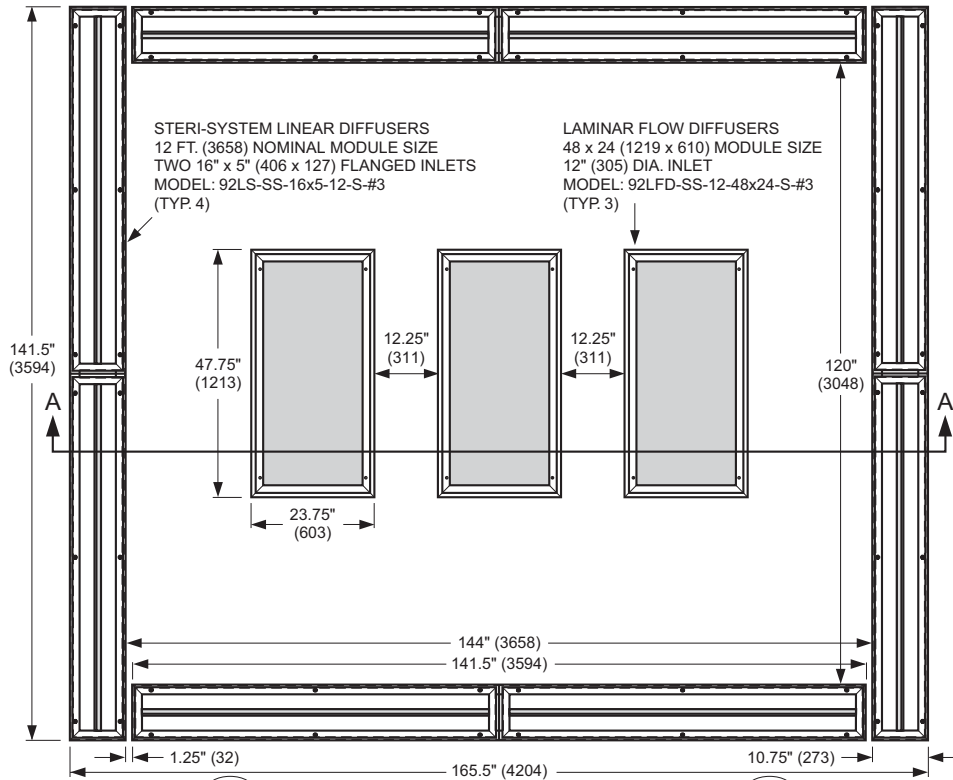
# = RECOMMENDED PERCENTAGE OF TOTAL SYSTEM AIRFLOW SUPPLIED THROUGH IDENTIFIED INLET.

Section Detail A – A Plenum Top View

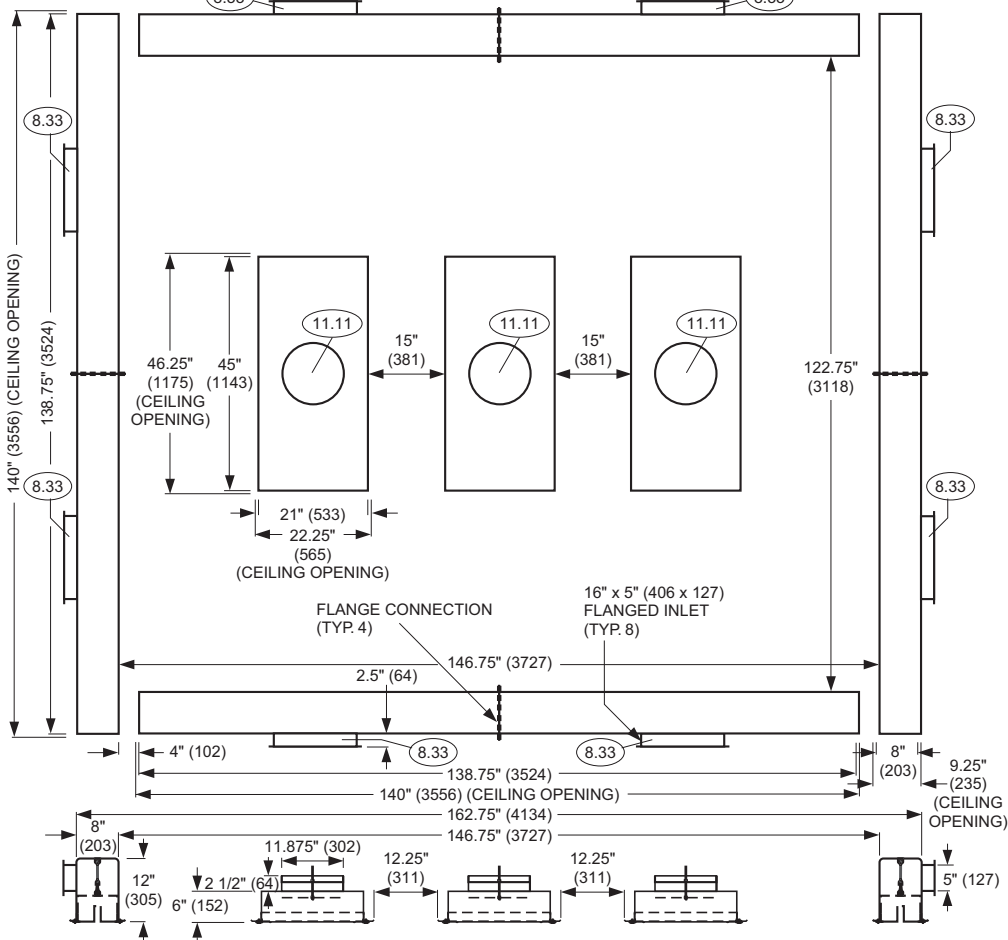


## Dimensional Data • Steri-System 12 x 10 Module • Model: 92STSYS – 12 x 10

Reflected Ceiling View

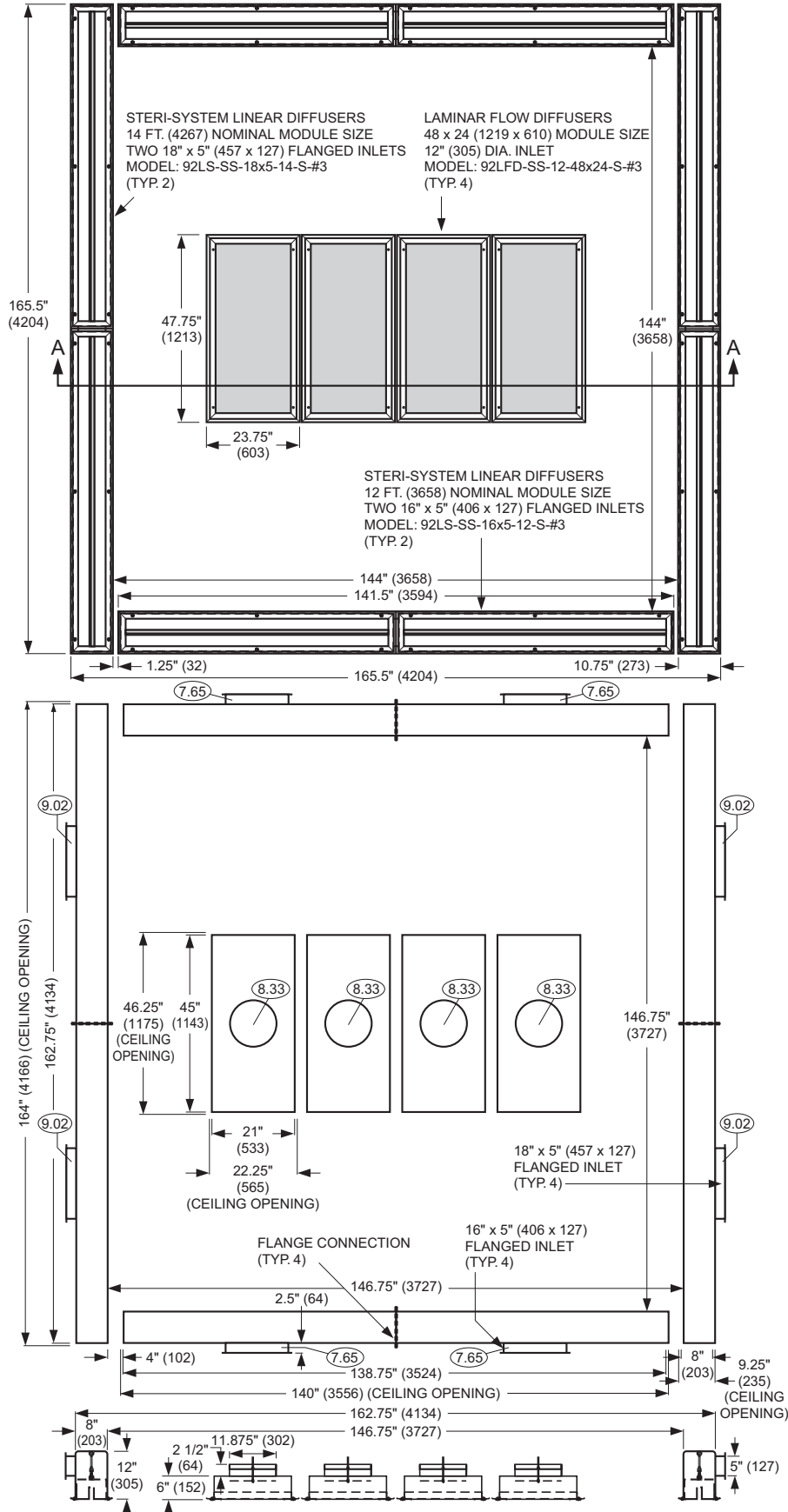


Plenum Top View



Section Detail A – A

## Dimensional Data • Steri-System 12 x 12 Module • Model: 92STSYS – 12 x 12



HOSPITAL/CLEANROOM DIFFUSERS

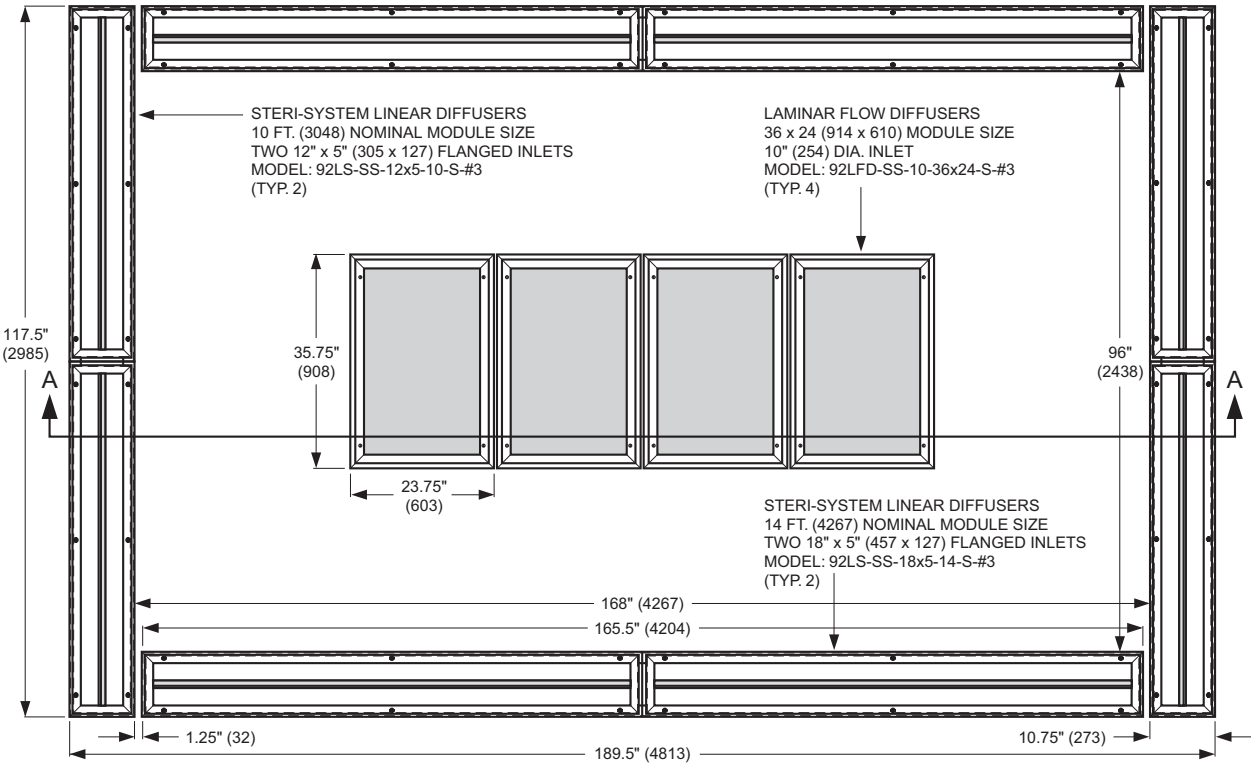
Reflected Ceiling View

Plenum Top View

Section Detail A - A

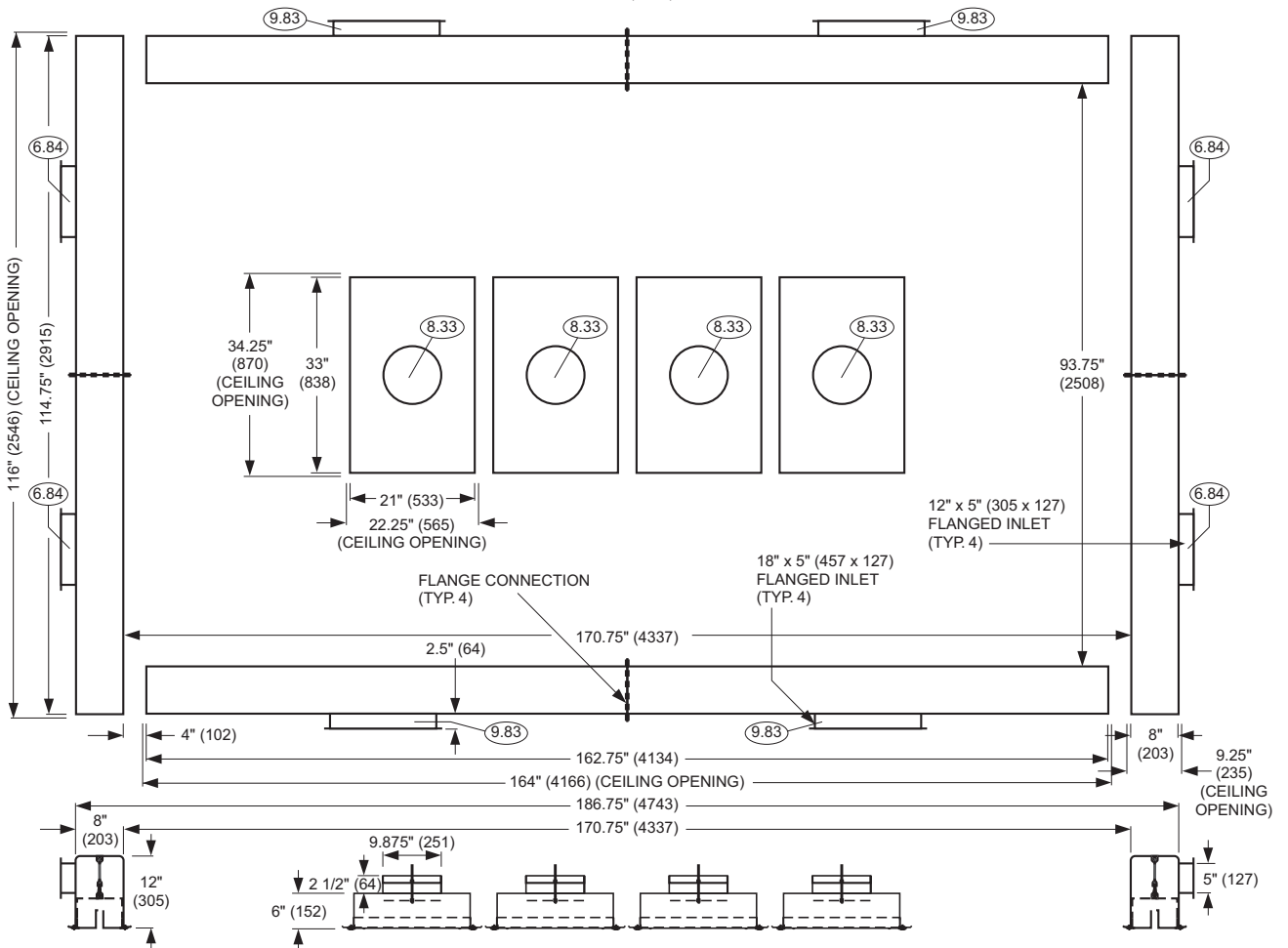
## Dimensional Data • Steri-System 14 x 8 Module • Model: 92STSYS – 14 x 8

Reflected Ceiling View



RECOMMENDED PERCENTAGE OF TOTAL SYSTEM AIRFLOW SUPPLIED THROUGH IDENTIFIED INLET

Section Detail A – A Plenum Top View

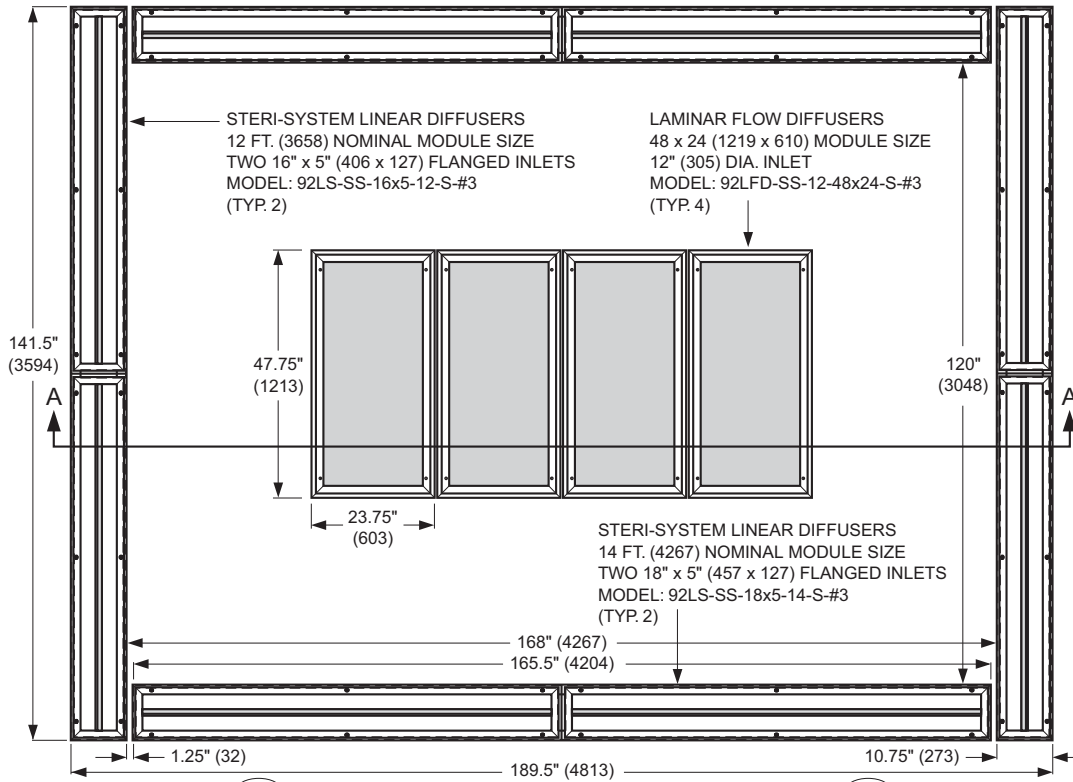


**E**

HOSPITAL / CLEANROOM DIFFUSERS

## Dimensional Data • Steri-System 14 x 10 Module • Model: 92STSYS – 14 x 10

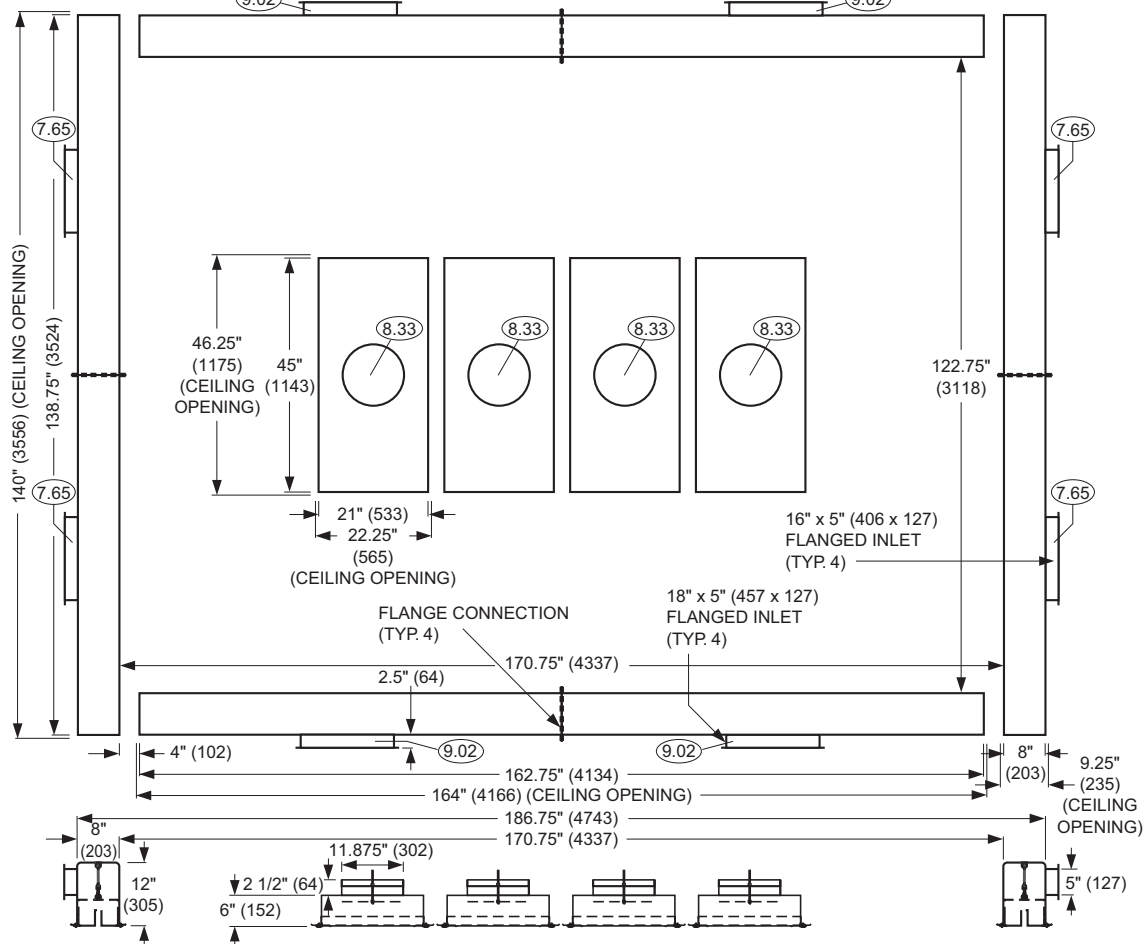
Reflected Ceiling View



HOSPITAL / CLEANROOM DIFFUSERS

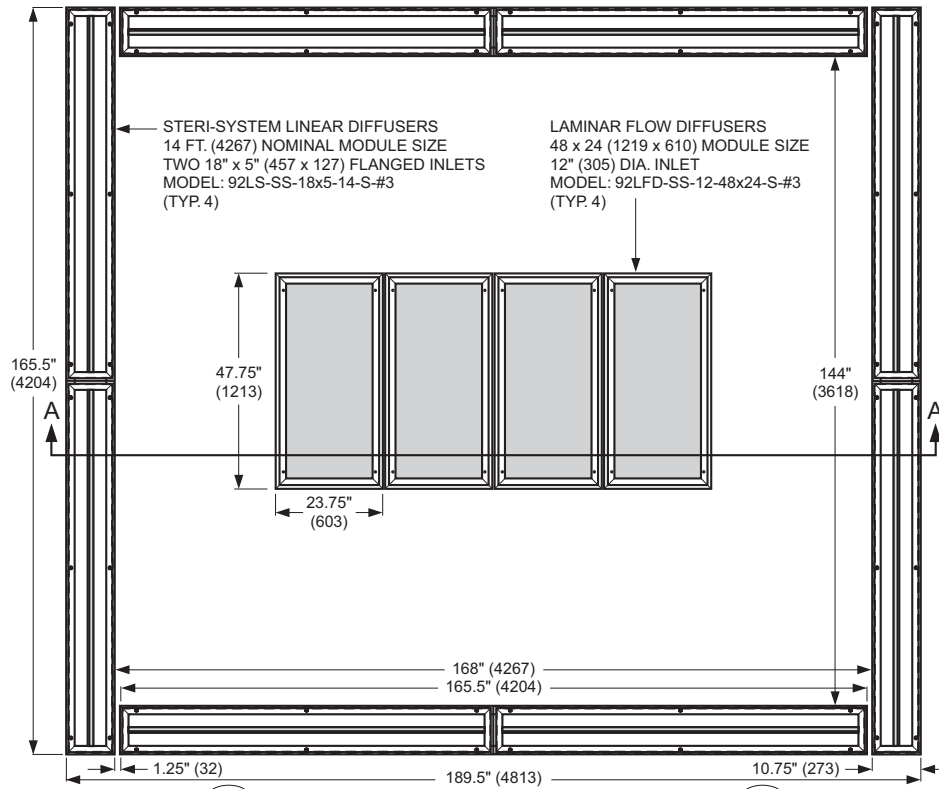
# = RECOMMENDED PERCENTAGE OF TOTAL SYSTEM AIRFLOW SUPPLIED THROUGH IDENTIFIED INLET.

Section Detail A – A Plenum Top View

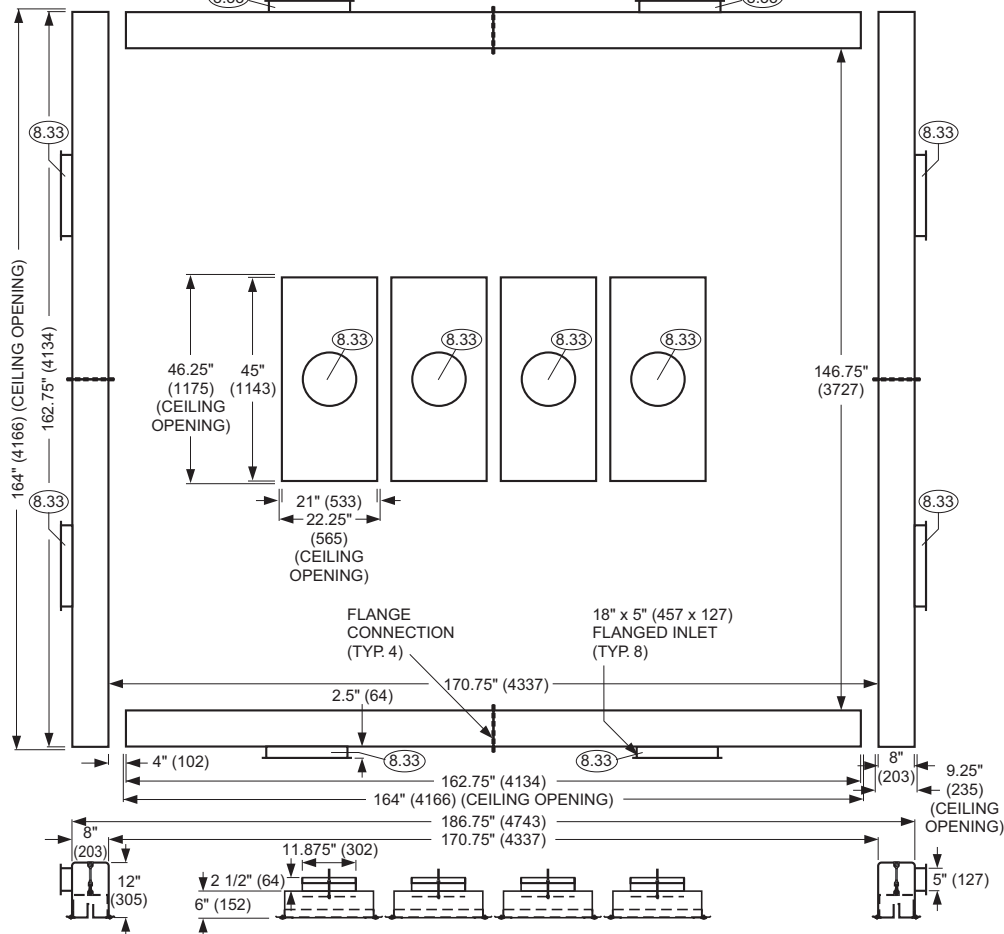


## Dimensional Data • Steri-System 14 x 12 Module • Model: 92STSYS – 14 x 12

Reflected Ceiling View



Plenum Top View



Section Detail A – A

HOSPITAL / CLEANROOM DIFFUSERS

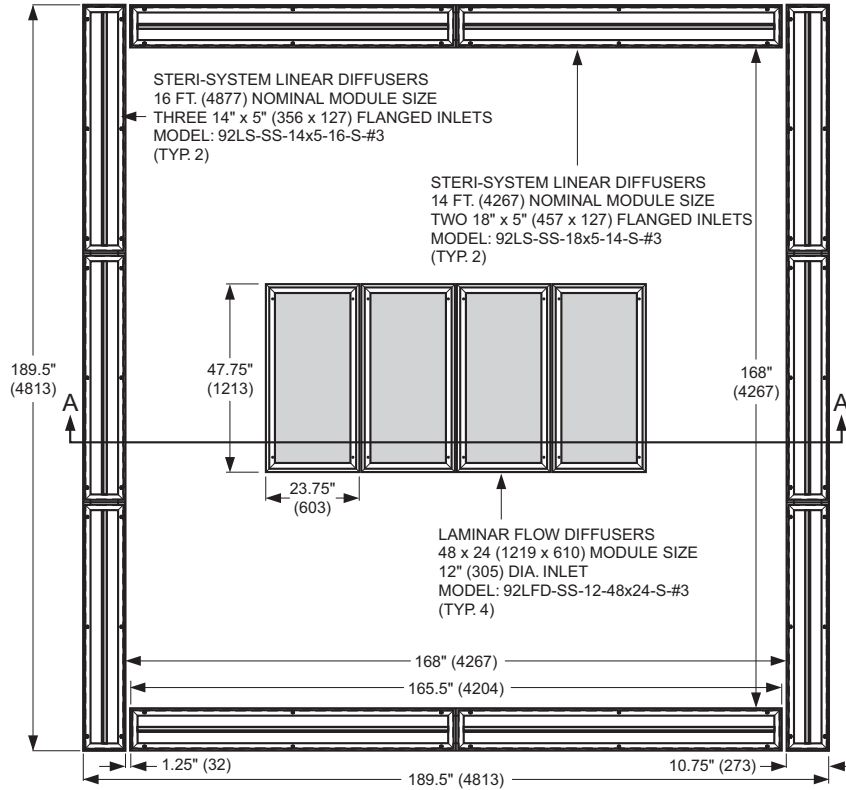


## Dimensional Data • Steri-System 14 x 14 Module • Model: 92STSYS – 14 x 14

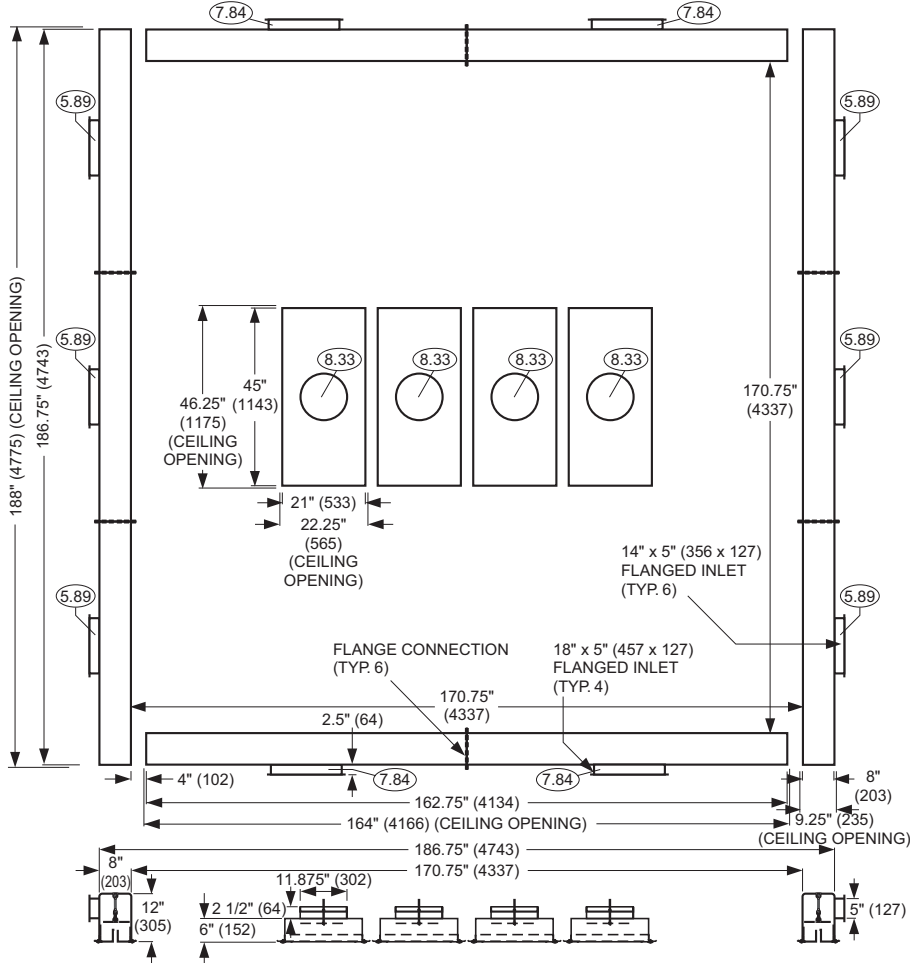


HOSPITAL / CLEANROOM DIFFUSERS

Reflected Ceiling View



Plenum Top View



RECOMMENDED PERCENTAGE OF TOTAL SYSTEM AIRFLOW SUPPLIED THROUGH IDENTIFIED INLET.

# =

Section Detail A – A

## HOW TO SPECIFY OR TO ORDER

(Show complete Model Number and Size, unless "Default" is desired).

### Stainless Steel Steri-System Hospital Operating Room Air Systems – Model Series 92STSYS

		<b>92STSYS - 12 x 10 - S - #3 - —</b>			
<b>MODEL</b>				<b>OPTIONS</b>	
- 304 Stainless Steel	92STSYS			- None (default)	—
- 304 Stainless Steel with Perimeter Inlet Balancing Dampers	92STSYS-O			- 316 Stainless Steel Construction	316
<b>NOMINAL MODULE SIZE (ft.) (mm)</b>				<b>FINISH</b>	
- 8 x 4 (2438 x 1219)				- #3 Satin Polished (default)	#3
- 8 x 6 (2438 x 1829)				- Special Custom Color	SP
- 8 x 8 (2438 x 2438)				<b>FRAME TYPE</b>	
- 10 x 6 (3048 x 1829)				- Lay-in T-Bar	L
- 10 x 8 (3048 x 2438)				- Surface Mount	S
- 10 x 10 (3048 x 3048)					
- 12 x 6 (3658 x 1829)					
- 12 x 8 (3658 x 2438)					
- 12 x 10 (3658 x 3048)					
- 12 x 12 (3658 x 3658)					
- 14 x 8 (4267 x 2438)					
- 14 x 10 (4267 x 3048)					
- 14 x 12 (4267 x 3658)					
- 14 x 14 (4267 x 4267)					

#### SUGGESTED SPECIFICATION:

Furnish and install **Nailor Steri-System Model 92STSYS Hospital Operating Room Air Systems** of the size and type shown on the plans and air distribution schedules. The system shall be specially designed to reduce airborne contaminants, and thus, the risk of patient infection during surgery. The system shall be composed of two main components, Model 92LFD-SS Laminar Flow Diffusers and Model 92LS-SS Linear Slot Diffusers, constructed as follows:

The Laminar Flow Diffusers shall be constructed entirely from 304 stainless steel (316 optional), minimum 24 gauge. The perforated face of the diffuser shall have 13% free area with 3/32" (2.4) dia. holes on 1/4" (6) staggered centers. The face shall incorporate a second pressure plate as an integral assembly to ensure true laminar airflow. The face shall be attached with 1/4 turn fasteners to allow for complete removal and access to the interior for cleaning. All diffusers are to include safety cables to prevent accidental dropping of the removable face. A disc type damper, adjustable from the face of the diffuser, shall be provided with all units. Integral earthquake hanger tabs shall be included with all units.

The Linear Slot Diffusers shall be constructed entirely from 304 stainless steel (316 optional), minimum 24 gauge. The diffuser shall incorporate a non-adjustable single slot designed to create a vertical air curtain angled outwards 5 – 15°. The diffuser shall incorporate a pressure plate behind the slot to ensure uniform slot velocity. The pressure plate shall be 13% free area with 3/32" (2.4) dia. holes on 1/4" (6) staggered centers. The slot and pressure plate shall be attached with 1/4 turn fasteners to allow for complete removal and access to the interior for cleaning. The plenum shall incorporate radiused corners lengthwise to facilitate cleaning. Flanged plenum inlets are to be maximum 5" (127) in height to allow duct clearance over standard light fixtures. Plenums over 7 ft. (2134) in length shall be supplied in multiple sections with flange connections and stainless steel fasteners for field assembly. All diffusers are to include safety cables to prevent accidental dropping of the removable face. Integral earthquake hanger tabs shall be included with all units. All exposed surfaces shall have a #3 satin polished finish (optional finishes are available).

(Optional) An opposed blade damper, adjustable from the face of the diffuser, shall be provided on all perimeter inlets. Dampers shall be held in place with wing nut fasteners and be removable from the face of the diffuser.

The manufacturer shall provide published performance data for the system, which shall be tested in accordance with ANSI/ASHRAE Standard 70 – 2006.

## SELECTION OF STERI-SYSTEM MODULE SIZE

The first step in determining module size is to determine the total supply airflow for the operating room. The following table summarizes the current guidelines for the various organizations shown.

The most stringent minimum number of air changes is published by ASHRAE and they are generally considered to be the code authority throughout the country. Some areas require a 100% outside air supply system which not only helps to reduce contaminants but can provide additional protection during a fire emergency. Operating rooms are obviously not easy to evacuate during a fire and the combination of a positive pressure and outside air can enhance smoke protection.

Based on these (or other) guidelines, determine the total number of air changes required for the operating room. With this and the room volume we can determine the total airflow to be supplied:

$$\text{Total Room Supply Airflow (cfm)} = \frac{\text{Total Room Volume (ft}^3\text{)} \times \text{\# of Room ACH}}{60}$$

We must then confirm that this airflow will fulfill the other requirements of the room such as cooling load and humidity requirements as well as maintaining the pressure relationships with the adjoining areas. Some systems must be capable of quickly reducing or increasing the room temperature and humidity during or between procedures and/or maintaining a lowered

design set point temperature of 60 – 65°F (15 – 18°C) during procedures. Also, best air distribution and comfort conditions are generally obtained when the supply air temperature differential during surgery is small and relatively constant. When the total room airflow is determined we can choose our Steri-System module size. From the chart on page E83 the total system airflow ranges and noise levels are shown. The system should be selected within the ranges shown on the chart with consideration as to final module size and its ability to accommodate the personnel and equipment as necessary. The standard systems shown have been designed to simplify the selection and layout process while providing maximum protection to the patient within the airflow ranges shown. The interior and perimeter pressure and flow relationships are maintained with 1/3 of the airflow being supplied through the laminar flow center panels and the remaining 2/3 through the perimeter curtain diffusers. Inlet sizes and air volumes per inlet have been designed to minimize sound and pressure drop and enhance system efficiency. The standard modules shown are only a small fraction of the possible combinations available and are sized to meet the most common conditions. If your particular requirements cannot be met with the standard module sizes, other combinations of laminar flow diffusers and/or perimeter curtains are available. Please contact your local Nailor representative for assistance on your particular application.

Source	Room Types	Minimum Air Changes/Hour ACH	Minimum Outside Air ACH	Minimum Filtration Efficiency
ASHRAE 2003 Handbook HVAC Applications	Operating Room Cystoscopic Rooms Delivery Room	25	5	Merv 17 (99.97%) for Orthopedic, Bone Marrow and Organ Transplant. Merv 14 (90%) for General Procedure and Delivery Rooms.
American Institute of Architects 2001 Edition Guidelines for Design & Construction of Hospital & Health Care Facilities	Operating/Surgical Cystoscopic Rooms Delivery Room Trauma Room Procedure Room	15	3	90%
	Bronchoscopy, Triage, ER or Radiology Waiting Rooms	12	3	
	Endoscopy	6	2	
Canadian Standards Assoc. CSA Standard Z317.2-01 September, 2001	Operating Rooms Endoscopy, Bronchoscopy, Cystoscopy, PACU, Surgical Day Care, Caesarean Delivery	20	6	99.97%

This table summarizes some of the current recommendations for operating room ventilation rates. Consult the actual documents for specific requirements and exceptions.

## Performance Data

### Steri-System • Hospital Operating Room Air Distribution Systems System Selection Chart:

#### Imperial Units

Module Size	Perimeter Slot Length (ft)	Perimeter Inlet Size(s) (Qty @ W x H)	Perimeter CFM Range (25-35-45 cfm/ft)	Center Panels Recommended Size (Qty @ Inlet – Module)	Center Panels CFM Range (Low-Med-High)	Total System CFM Range (Low-Med-High)	Total System NC (Low-Med-High)
8 x 4	25.17	2 @ 16 x 5, 4 @ 10 x 5	630-880-1135	2 @ 10" dia – 36 x 24	315-440-565	945-1320-1700	25-29-34
8 x 6	28.5	8 @ 10 x 5	715-1000-1285	2 @ 12" dia – 48 x 24	355-500-640	1070-1500-1925	23-25-29
8 x 8	32.5	4 @ 12 x 5, 4 @ 10 x 5	815-1140-1465	3 @ 10" dia – 36 x 24	405-570-730	1220-1710-2195	25-29-33
10 x 6	32.5	4 @ 12 x 5, 4 @ 10 x 5	815-1140-1465	3 @ 10" dia – 36 x 24	405-570-730	1220-1710-2195	25-29-33
10 x 8	36.5	8 @ 12 x 5	915-1280-1645	3 @ 10" dia – 48 x 24	455-640-825	1370-1920-2470	25-28-32
10 x 10	40.5	4 @ 16 x 5, 4 @ 12 x 5	1015-1420-1825	3 @ 12" dia – 48 x 24	505-710-910	1520-2130-2735	24-26-29
12 x 6	36.5	4 @ 16 x 5, 4 @ 10 x 5	915-1280-1645	4 @ 10" dia – 36 x 24	455-640-825	1370-1920-2470	25-29-32
12 x 8	40.5	4 @ 16 x 5, 4 @ 12 x 5	1015-1420-1825	3 @ 12" dia – 48 x 24	505-710-910	1520-2130-2735	24-26-29
12 x 10	44.5	8 @ 16 x 5	1115-1560-2005	3 @ 12" dia – 48 x 24	555-780-1000	1670-2340-3005	24-27-32
12 x 12	48.5	4 @ 18 x 5, 4 @ 16 x 5	1215-1700-2185	4 @ 12" dia – 48 x 24	605-850-1090	1820-2550-3275	22-27-28
14 x 8	44.5	4 @ 18 x 5, 4 @ 12 x 5	1115-1560-2005	4 @ 10" dia – 36 x 24	555-780-1000	1670-2340-3005	26-30-34
14 x 10	48.5	4 @ 18 x 5, 4 @ 16 x 5	1215-1700-2185	4 @ 12" dia – 48 x 24	605-850-1090	1820-2550-3275	22-27-28
14 x 12	52.5	8 @ 18 x 5	1315-1840-2365	4 @ 12" dia – 48 x 24	655-920-1180	1970-2760-3545	26-26-30
14 x 14	55.83	6 @ 14 x 5, 4 @ 18 x 5	1395-1955-2510	4 @ 12" dia – 48 x 24	700-975-1255	2095-2930-3765	24-24-32

#### Metric Units

Module Size	Perimeter Slot Length (m)	Perimeter Inlet Size(s) (Qty @ W x H)	Perimeter l/s Range (38.7-54.2-69.7 l/s/m)	Center Panels Recommended Size (Qty @ Inlet – Module)	Center Panels l/s Range (Low-Med-High)	Total System l/s Range (Low-Med-High)	Total System NC (Low-Med-High)
8 x 4	7.672	2 @ 406 x 127, 4 @ 254 x 127	297-415-536	2 @ 254" dia – 914 x 610	149-208-267	446-623-802	25-29-34
8 x 6	8.687	8 @ 254 x 127	337-472-606	2 @ 305" dia – 1219 x 610	168-236-302	505-708-908	23-25-29
8 x 8	9.906	4 @ 305 x 127, 4 @ 254 x 127	385-538-691	3 @ 254" dia – 914 x 610	191-269-344	576-807-1036	25-29-33
10 x 6	9.906	4 @ 305 x 127, 4 @ 254 x 127	385-538-691	3 @ 254" dia – 914 x 610	191-269-344	576-807-1036	25-29-33
10 x 8	11.125	8 @ 305 x 127	432-604-776	3 @ 254" dia – 1219 x 610	215-302-389	647-906-1166	25-28-32
10 x 10	12.344	4 @ 406 x 127, 4 @ 305 x 127	479-670-861	3 @ 305" dia – 1219 x 610	238-335-429	717-1005-1291	24-26-29
12 x 6	11.125	4 @ 406 x 127, 4 @ 254 x 127	432-604-776	4 @ 254" dia – 914 x 610	215-302-389	647-906-1166	25-29-32
12 x 8	12.344	4 @ 406 x 127, 4 @ 305 x 127	479-670-861	3 @ 305" dia – 1219 x 610	238-335-429	717-1005-1291	24-26-29
12 x 10	13.564	8 @ 406 x 127	526-736-946	3 @ 305" dia – 1219 x 610	262-368-472	788-1104-1418	24-27-32
12 x 12	14.783	4 @ 457 x 127, 4 @ 406 x 127	573-802-1031	4 @ 305" dia – 1219 x 610	285-401-514	859-1203-1545	22-27-28
14 x 8	13.564	4 @ 457 x 127, 4 @ 305 x 127	526-736-946	4 @ 254" dia – 914 x 610	262-368-472	788-1104-1418	26-30-34
14 x 10	14.783	4 @ 457 x 127, 4 @ 406 x 127	573-802-1031	4 @ 305" dia – 1219 x 610	285-401-514	859-1203-1545	22-27-28
14 x 12	16.002	8 @ 457 x 127	621-868-1116	4 @ 305" dia – 1219 x 610	309-434-557	930-1302-1673	26-26-30
14 x 14	17.017	6 @ 356 x 127, 4 @ 457 x 127	658-923-1184	4 @ 305" dia – 1219 x 610	330-460-592	989-1383-1777	24-24-32

#### Performance Notes:

1. Data derived from tests conducted in accordance with ANSI/ASHRAE Standard 70 – 2006.
2. Noise Criteria (NC) values based on 10 dB room absorption re 10<sup>-12</sup> watts with dampers fully open.

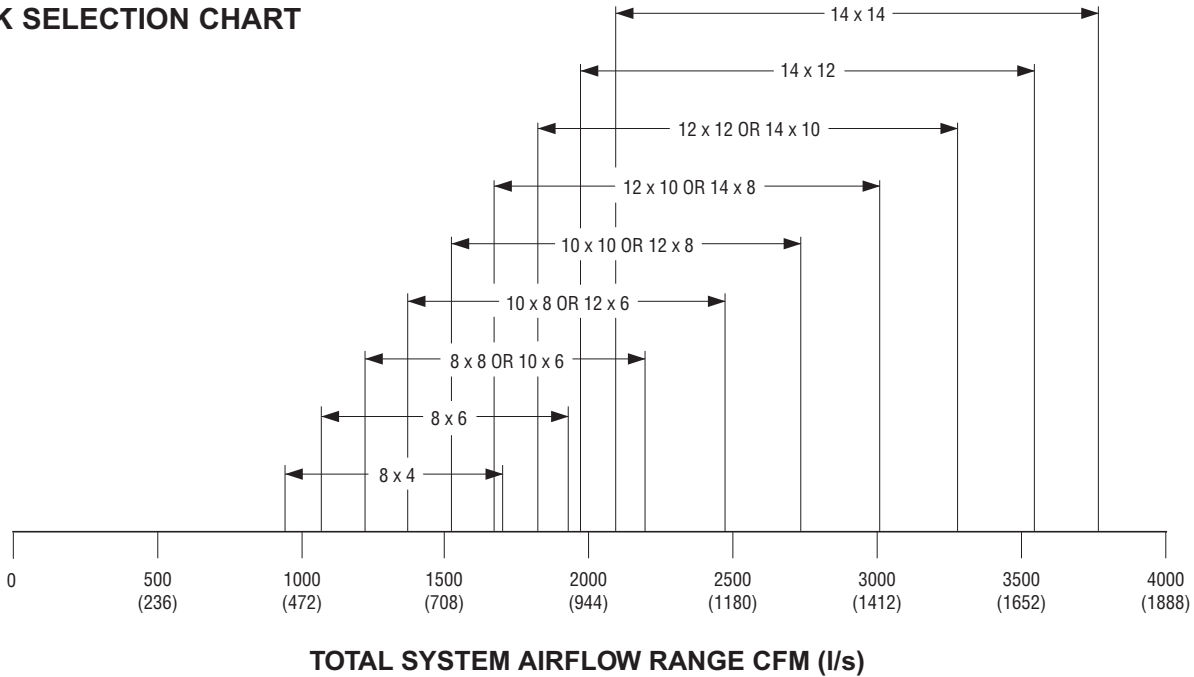
3. Airflows to be selected based on 1/3 of total airflow through the center panels and the remaining 2/3 through the perimeter. Refer to Steri-System plenum drawings for the recommended percentage of total airflow per individual inlet.

4. To accommodate various ceiling configurations such as lights and equipment, center panels and layouts can be varied slightly. It is important to maintain panel areas and overall configuration for proper performance. Contact your local Nailor representative for assistance on your particular application.

## Performance Data

### Steri-System • Hospital Operating Room Air Distribution Systems

#### QUICK SELECTION CHART



TOTAL SYSTEM AIRFLOW RANGE CFM (l/s)

#### SELECTION EXAMPLE

Design Criteria: General Procedure Operating Room  
 Room Size: 20 ft wide x 25 ft long x 10 ft ceiling height  
 = 5000 ft<sup>3</sup> Room Volume  
 Minimum: 8 ft x 8 ft Clean Zone Required  
 Supply Air Temperature: 55°F  
 Room Temperature Set Point Range: 62 – 80°F  
 Airflow: Minimum 25 ACH (recirculating system) –  
 Positive room pressure  
 Sound Level: 25 – 35 NC

Calculate required room airflow rate:

$$\text{Airflow (cfm)} = \frac{\text{Room Volume (ft}^3\text{)} \times \text{ACH}}{60}$$

$$\text{Airflow (cfm)} = 5000 \times 25/60 = 2083 \text{ cfm}$$

We must then confirm that this airflow will meet the maximum cooling load requirement for the room (not shown). Note that the room temperature must be able to be maintained at the lowest specified temperature for some procedures (62°F in this example). With a 55°F supply air temperature the load may, in some cases, require an increase in airflow to compensate for the low ΔT between supply air and room temperature. Also some procedures may require the system to quickly reduce or increase the room temperature and humidity during or between procedures. One of the features of the Steri-System design concept is the creation of a micro-climate within the clean zone. The enhanced air change rate within the curtain (Refer to Table 1 in the Engineering Section) and the use of non-aspirating Laminar Flow Diffusers create a room within a room effect. An analysis of the cooling load within the air curtain should be considered for critical

projects. Obviously, for the 80°F set point, the reheat coil and modulating valve must be sized accordingly. (Refer to the Nailor VAV Terminal Units catalog for more information on reheat coil selection).

From the selection chart we see that the airflow falls midrange for a 12 x 8 Steri-System module size which meets our minimum specified clean zone size. From the module layout page we have all the pertinent dimensions as well as recommended inlet sizes and airflows. This should be co-ordinated with the desired ceiling layout for surgical lighting, utility columns, monitors and equipment etc.. Several different module sizes will meet the specified criteria and the choice will generally depend on the layout. (Placement of diffusers above the table should take priority over placement of light fixtures).

Also from the selection chart, we find a system NC level of 26 which falls well within the recommended sound levels. Therefore a standard 12 x 8 Module Steri-System will meet our criteria for this example.

For return air grille sizing and room pressurization we will use the recommended 85% of the supply air total and a minimum of two inlets.

Therefore:

$$\text{Total Return Air} = \text{Supply Airflow} \times 0.85 = 2083 \times 0.85 = 1770 \text{ cfm total}$$

or for two inlets

$$= 885 \text{ cfm each}$$

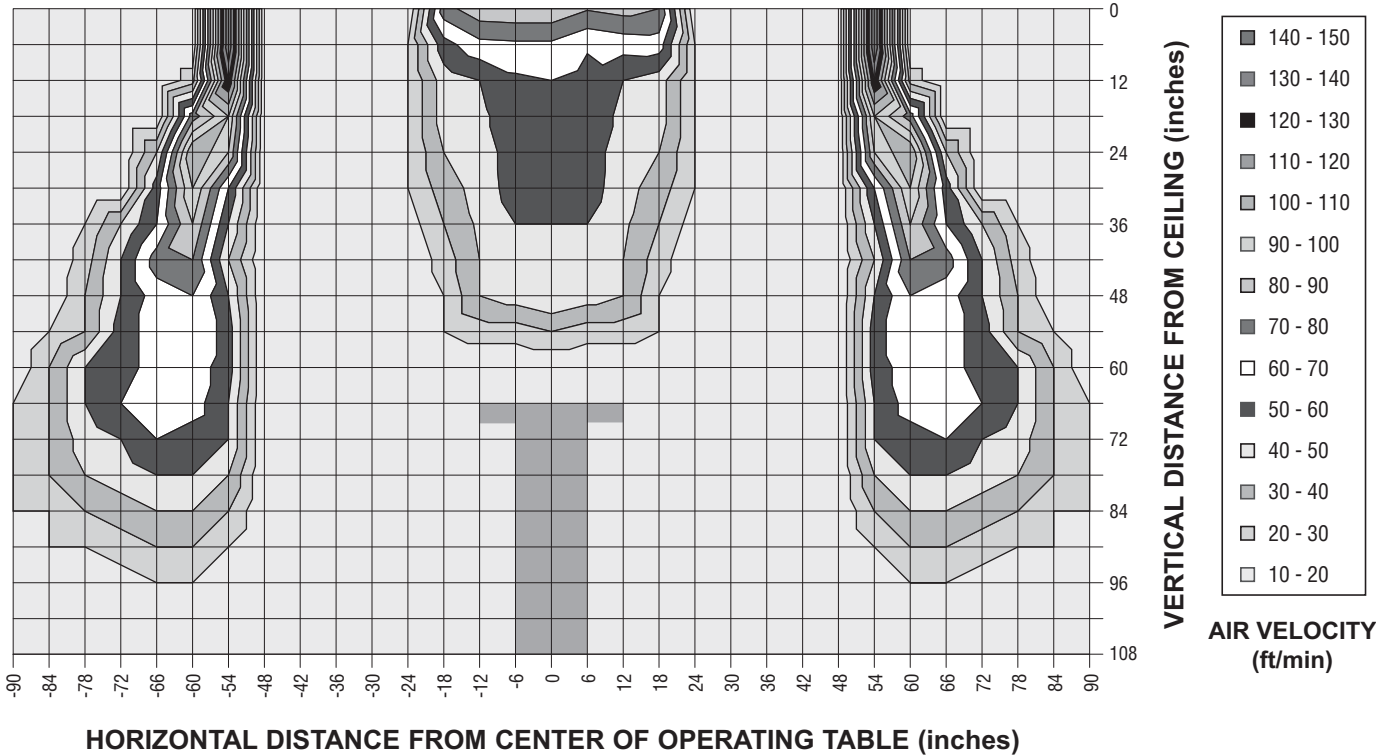
For a standard Model 67FB45 and sizing for low sound and pressure drop we find that two grilles 18" x 18" (or equivalent size) will be sufficient, resulting in a low noise level (< NC 20) and pressure drop (< 0.1" w.g.).

## Performance Data

### Steri-System • Hospital Operating Room Air Distribution Systems

#### PERFORMANCE TEST – 12 x 8 STERI-SYSTEM MODULE

(Medium Airflow Range – 35 cfm/ft Perimeter / 30 cfm/sq. ft Center Panels)



**NOTE:**

The graph above shows actual air velocities and the associated isovels. This data was obtained in a full scale mock-up test performed on a standard 12 x 8 Steri-System module under isothermal conditions.

**Performance Notes:**

1. Data derived from tests conducted in accordance with ANSI/ASHRAE Standard 70 – 2006.
2. Performance is for standard 12 x 8 module Steri-System under isothermal conditions.
3. Perimeter Airflow = 1420 cfm (670 l/s).  
Laminar Airflow = 710 cfm (335 l/s).  
Total Airflow = 2130 cfm (1005 l/s).



Photo shows standard 12 x 8 Steri-System module installed in the Nailor Air Distribution laboratory.



HOSPITAL / CLEANROOM DIFFUSERS



## OPERATING ROOM AIR DISTRIBUTION: ENGINEERING GUIDELINES

### INTRODUCTION

In the United States there are approximately 46.5 million surgical procedures performed each year (1996 Data published November 1998 by CDC/National Center for Health Statistics). An analysis of 1.16 million surgical procedures reported 29.4 thousand (2.54%) Surgical Site Infections (SSI's) (Data Summary from January 1992 – June 2001 CDC/National Nosocomial Infections Surveillance System Report published August 2001).

While 2.54% may appear to be a relatively small and acceptable incidence of surgical site infection we must consider a broader scope and allow some assumptions to fully understand its true implications and effect on our lives and those around us. When we look at the total number of procedures itself we must realize that in 1996 the United States population was approximately 264 million people. Therefore, there is an overall average of 17.6% percent of Americans (1 in every 5.7 people) that have some kind of surgical procedure performed each year. If we further expand this and assume the average lifespan to be 75 years we see that the average person will have 13.2 surgical procedures performed in their lifetime. With a 2.54% average incidence of infection each time, this means that over a lifetime at current rates the average American actually has a 28.8% chance (1 in every 3.5 people) of getting a surgical site infection.

A 1992 analysis showed that each SSI resulted in an additional 7.3 postoperative hospital days adding \$3,152 in extra charges. With almost 1.2 million incidences of SSI each year that adds up to a truly staggering figure of over 3.7 billion dollars each year. For the case of a typical operating room we find that the average time for a procedure is about 2.1 hours. As most operating rooms are available for eight hours a day, this results in approximately 3 operations per day per room. This works out to 750 procedures per year resulting in an average of 19 cases of SSI per year with an extra annual cost of \$60,000 per operating room.

When we examine the nature of these surgical site infections we find that approximately two thirds are confined to the incision, and one third involved organs or spaces accessed during the operation (deep SSI's). Data is not available on the total number of deaths each year caused by SSI, however when patients with SSI died, 77% of the deaths were reported to be related to the infection and the majority (93%) were serious infections involving organs or spaces accessed during the operation (deep SSI's) (the mortality rate is currently estimated to be between 1 and 3%, or 12,000 – 36,000 people per year).

Despite continuing advances in medical science surgical site infections remain a substantial cause of morbidity

and mortality among hospitalized patients. There are many emerging trends in the healthcare environment which are contributing to this. One such trend is the evolution of treatment resistant bacteria. The most common cause of SSI is a bacteria called *Staphylococcus aureus* accounting for approximately 20% of cases. Before the 1950's it was treated effectively with penicillin, however it developed a resistance to penicillin and doctors had to switch to methicillin. By the 1970's it had developed a resistance to methicillin causing a switch to vancomycin. In the last few years the first strains resistant to vancomycin have been detected and doctors and researchers are now actively searching for a new alternative treatment and are implementing new guidelines for its prevention and control. It is important to note that as various pathogens develop resistance to standard treatment, some much faster than *Staphylococcus aureus*, the doses and types of medication get stronger. However as this occurs the resulting side effects, treatment time and costs also increase.

Another emerging trend in healthcare is the increased numbers of immunocompromised patients and immune suppressing treatments. This includes an increased number of patients who are elderly and/or have a wide variety of chronic, debilitating or immunocompromising underlying diseases. Examples of this include increasing numbers of HIV/AIDS patients, tuberculosis patients and cancer patients undergoing chemotherapy. There are also increased numbers of prosthetic implant, bone marrow transplant and organ transplant operations performed where the immune system is intentionally suppressed. Also, the hospital environment itself is changing with shorter stays for most procedures and increased numbers of outpatient or ambulatory surgeries being performed. The result is that actual hospitalized patients are less healthy now than ever before.

The best way to treat an infection is to stop it from occurring in the first place.

There is very little information available as to the effects of operating room ventilation alone on the rates of SSI's. Many studies have been done, however, they typically involve several different factors and only specific types of operations, therefore not allowing broad application of their results. One such study involved the use of ultraclean air (HEPA filtered) supplied through laminar flow ceiling diffusers. This multicenter study examined 8,000 total hip and knee replacements and found that the rate of deep SSI's decreased from 3.4% to 1.6% when ultraclean air was used. While this is a dramatic decrease we cannot assume that all procedures will show similar results, as different procedures and patient groups have different susceptibility to airborne infections and many other factors could easily confound the results. The outcome of this, which is somewhat surprising with the studies available, is that most medical literature does not fully endorse the use of, or even recommend the implementation of so called specialty ventilation systems.



It is truly incredible to note that our standard desktop computers are manufactured in an environment with air much cleaner than that in which we are operated on.

We must now ask ourselves how we can apply sound engineering principles in the design of the operating room HVAC system to reduce the incidence of infection while providing our clients with a practical, efficient and cost effective design solution.

## SYSTEM SELECTION

Selecting the proper air distribution system for the modern operating room can be a very confusing process. There are a wide variety of sources of conflicting information, studies and papers on the subject. Over the past 50 years there have been many attempts to justify particular systems and many manufacturers have made claims as to the suitability and superiority of their particular system with little or no consensus on the subject of whether a specialty system should exist at all. While some authorities believe clean air systems are not necessary, recent testing and various studies have shown a reduction in infection rates and, as far as we are aware, no studies have shown, and common sense would agree, that supplying clean or ultra clean air in a directed fashion within the operating room is in any way detrimental to the patient. The modern hospital environment is rapidly changing; with the increased numbers of elderly and/or immunocompromised patients and new treatment resistant diseases, the prevention of infection is becoming more important than ever. When one considers the financial costs associated with surgical site infections due to increased hospital stays, treatments, and potential litigation, not to mention increased mortality rates, it seems obvious that if the system prevents even one infection over its lifetime it is well worth the minor cost associated with it (especially to that one patient). It is also important to note that a standard Steri-System module generally costs much less than the operating table itself, while providing much greater benefit to the patient.

The major source of microbiological particles in the operating room is from the surgical staff and is proportional to the number of people moving about in the room. Therefore the goal of any system has to be the isolation of the patient from the microbiological particles produced by the surgical team and the support staff in the operating room.

## TYPES OF SYSTEMS

There are three basic types of specialty systems:

### VERTICAL LAMINAR FLOW

Probably the oldest and most common type in use today, it consists of an array of laminar flow diffusers or panels located over the operating room table. It has been used extensively in orthopedic and other very critical areas. This system works very well if the supply diffuser area is

very large compared to the work area, however this requires very high airflow rates typically in the range of 50 – 400 ACH (refer to Figure 1). One such test with ventilation rates exceeding 60 ACH, HEPA filtration and with the surgical team wearing special clothing resulted in extremely low concentrations of microbial particles  $0.057 \text{ cfu/ft}^3$  ( $2 \text{ cfu/m}^3$ ) ( $\text{cfu} = \text{colony forming units}$ ). Much higher concentrations,  $2.8 \text{ cfu/ft}^3$  ( $100 \text{ cfu/m}^3$ ), considered by many to be unacceptable, have been measured at 15 – 17 ACH. Many factors will influence these measurements (refer to System Testing section below). Objects and heat dissipation from people and lamps, and door openings/closings can disturb the flow field. The laminar airflow itself will tend to coalesce into a much smaller cross sectional area as it leaves the diffusers or ceiling. This results in a much smaller area of coverage than generally anticipated. The general idea is to cover the patient and surgical staff, however, the airflow can coalesce on as much as a  $45^\circ$  angle in from the ceiling depending on temperature. The result is that for a 6 ft x 6 ft (2 m x 2 m) clean zone containing the table and surgical staff, the actual area of the diffusers at the ceiling may be 18 ft x 18 ft (6 m x 6 m) for proper containment (refer to Figures 2 and 3). Methods to improve the containment of the laminar airflow at reduced volumes include the use of hanging curtains and ceiling hung deflecting walls or partitions, most of which are not popular with surgeons and OR personnel (refer to Figure 4). Care must be taken to select and layout the diffusers with as little space between them as possible, to reduce the induction of contaminated room air into the airstream and to avoid stagnant or low velocity areas that will trap contaminants. Selecting a complete vertical laminar flow system requires precise knowledge of the expected loads and the resultant temperature differential between the supply air and the space temperature. With laminar flow from the ceiling the air velocity will be very dependent on the temperature of the air. During cooling, the center portion will actually accelerate due to the mass effect of the cold air. Therefore the velocity on the patient can be substantially higher than the actual outlet velocity. Excessive air velocity on the wound site can cause a drying effect on the wound (tissue) and lead to possible complications. Also hypothermia can be caused due to the evaporative cooling effect.

There are no specific recommendations for this type of system as very few people agree on the specifics for testing and the results are also affected by the total area of the diffusers, total air volume, the distance between them (2 diffusers side by side will throw the air further) and the temperature differential. If the temperature differential is very small,  $< 10^\circ\text{F}$  ( $6^\circ\text{C}$ ), and the area of the diffuser is relatively large with little or no spaces between the diffusers, accurate results in predicting the airflow velocity can be attained. Refer to ASHRAE Applications Handbook for more information.

## VERTICAL LAMINAR FLOW WITH AIR CURTAIN

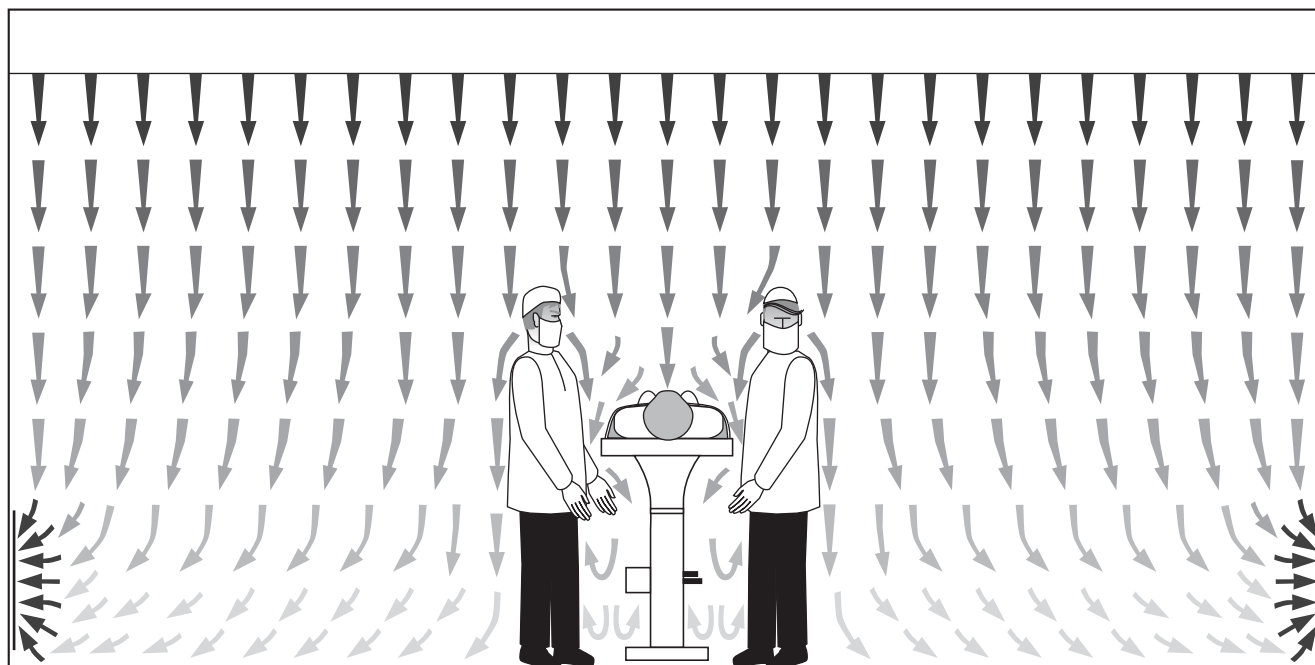
This system consists of two or more laminar flow diffusers located over the operating room table surrounded by a low velocity air curtain created by a special slot diffuser (refer to Figure 5). The air curtain is directed outwards, thus isolating the operating table from induced room air. Typically, two thirds of the supply airflow is directed through the perimeter curtain and the remaining one third directed through the laminar flow diffusers over the operating table. This is a very good alternative to the above systems as it allows for lower air volumes to be utilized (15 – 50 ACH) while still maintaining clean laminar airflow within the curtain. The number of air changes within the curtain is significantly increased over that for the entire room (refer to Table 1). With lower air exchange rates commonly being specified it becomes the system of choice for most operating room applications. A vertical laminar flow with air curtain system is also much more friendly to design as it provides only one third of its air volume through the center panels, which are usually uniformly spaced within the air curtain and over the operating table. This allows the prediction of much more accurate estimates of throw velocity as the manufacturer's standard data can be used with corrections for temperature and spacing. The Nailor Steri-System Operating Room Air Distribution System is an example of this type of system which has incorporated the most modern design concepts into a tried and proven product resulting in the industry's most advanced engineered system.

## HORIZONTAL LAMINAR FLOW

Recommended by various manufacturers as an alternative to the systems above, however, there are problems associated with maintaining laminar airflow across the entire room, especially on cooling (refer to Figure 6). Also the air moves across contaminated personnel and equipment before reaching the patient, resulting in localized areas of turbulent flow and low velocity recirculation zones, thus possibly increasing the risk of infection. Larger amounts of both particles and bacteria have been detected with horizontal laminar flow systems at the same airflow as vertical laminar flow systems. Almost all literature recommends a ceiling mounted air distribution system, not horizontal, for use in operating rooms.

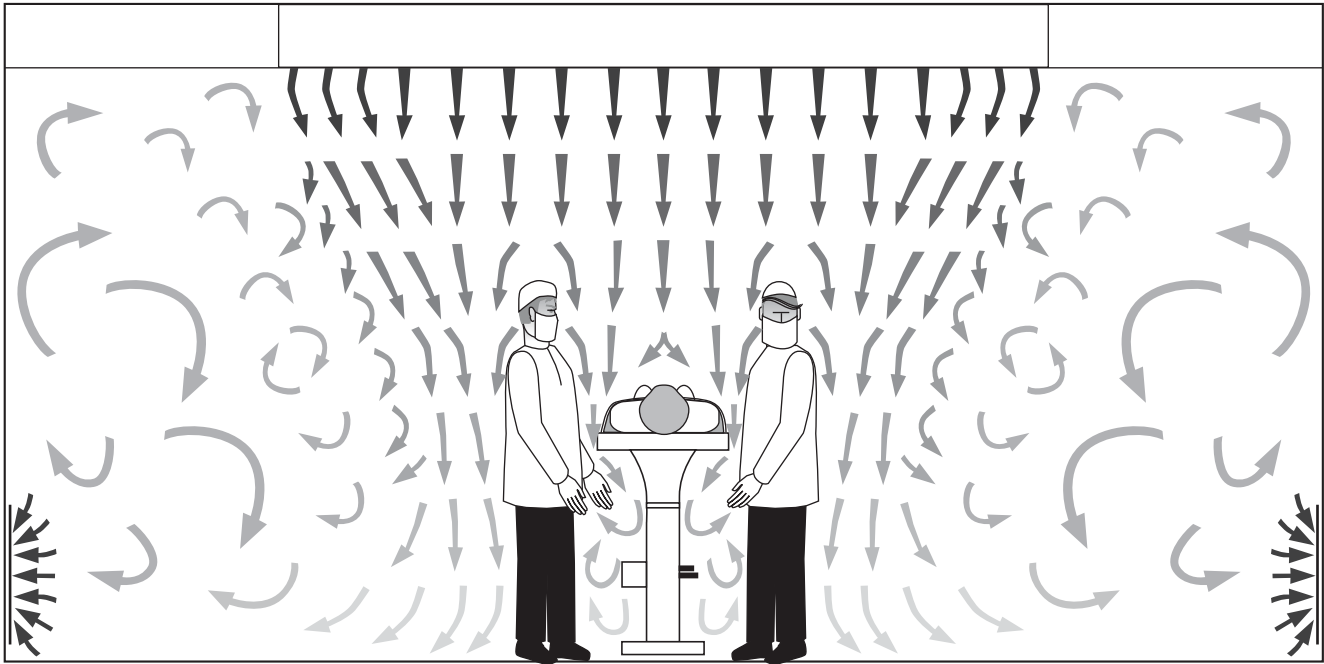
Horizontal laminar flow systems, while very common in protective environment rooms and industrial or pharmaceutical applications, do not lend themselves well to a typical operating room theatre and therefore should only be evaluated for very specific reasons.

There are actually several other types of systems and approaches that have been used such as displacement ventilation (floor to ceiling), conventional mixing, air jets and exhaust walls. These systems, while they do all have some merit, are generally not recognized or proven to be as effective.

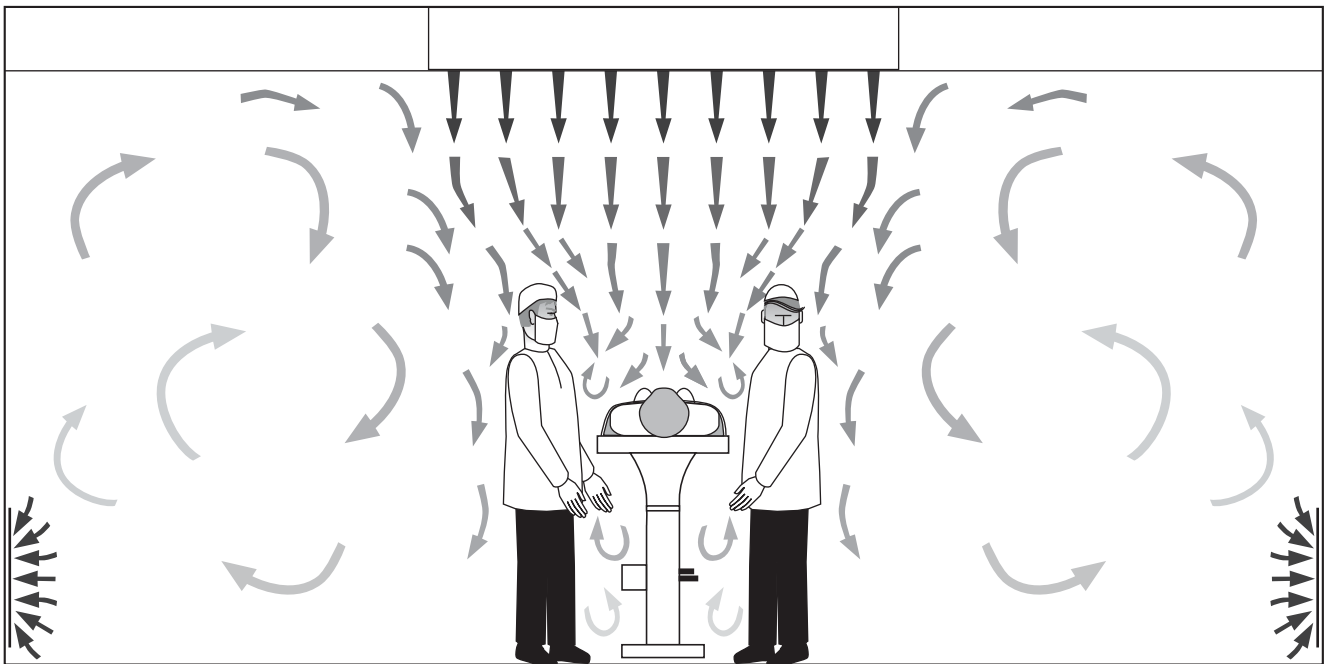


**FIGURE 1:**

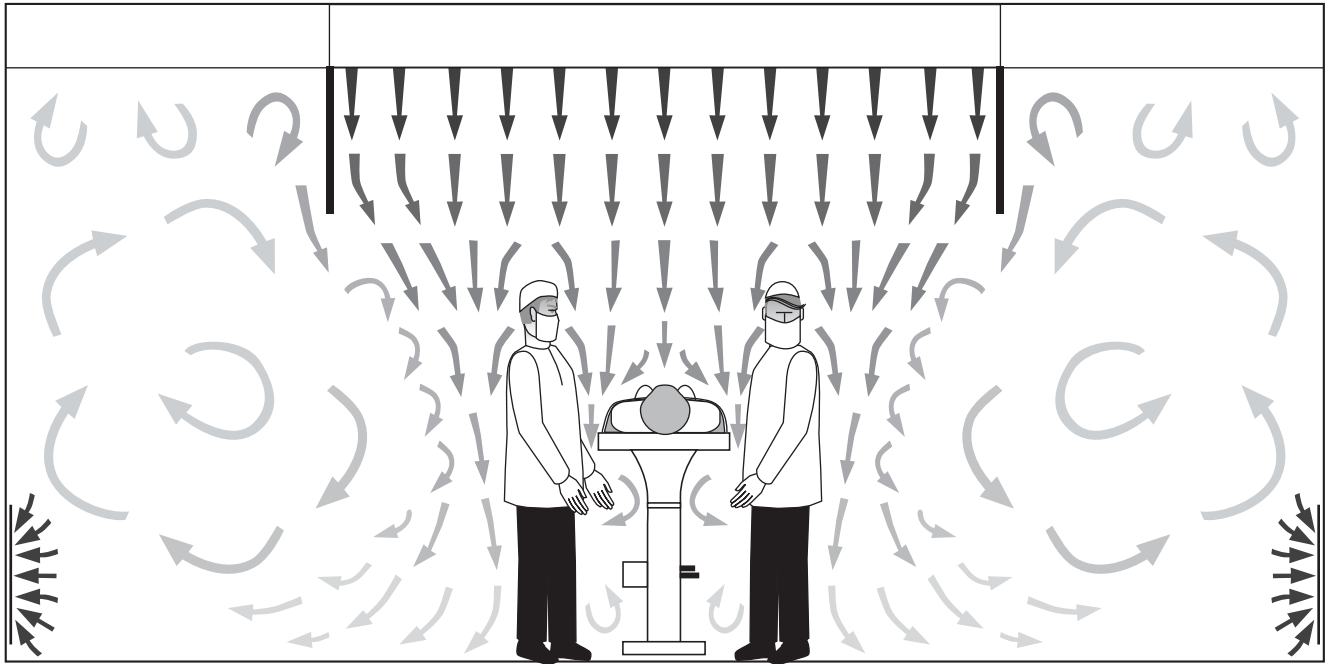
Complete Laminar Flow Ceiling System. Excellent protection of the patient from all sources of contaminants. Requires very high air volumes.



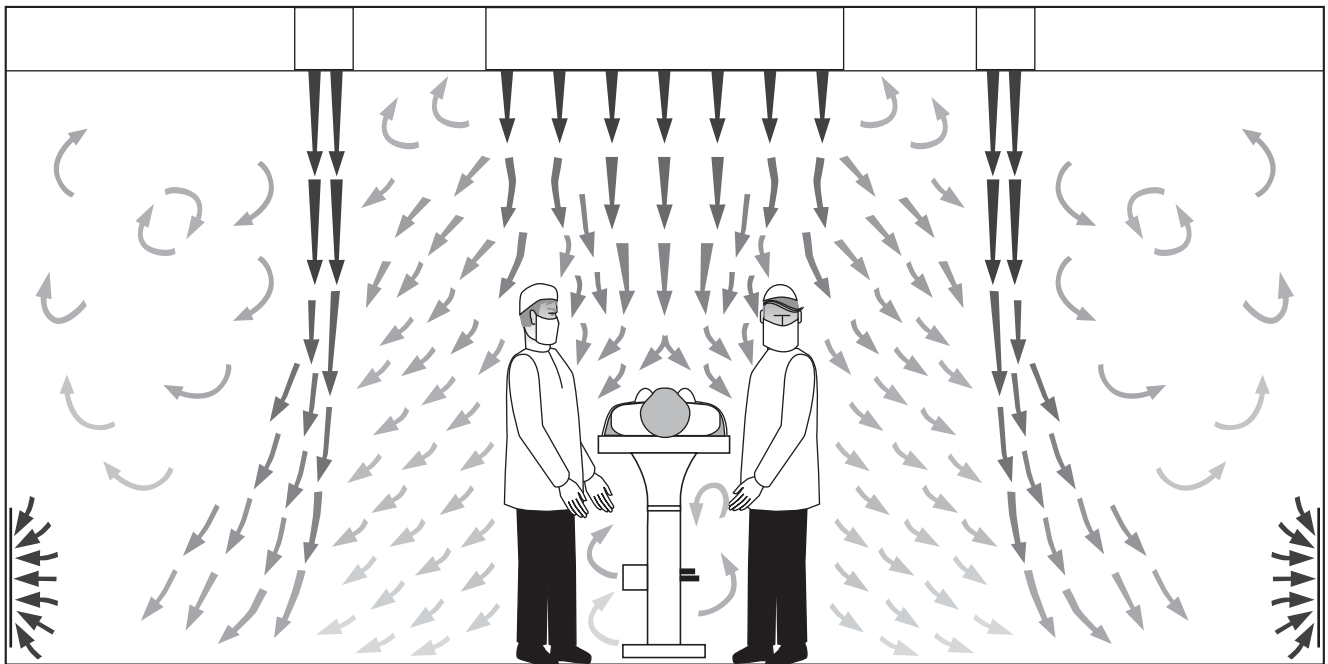
**FIGURE 2:**  
Large Area Laminar Flow Ceiling System. Very good protection of the patient from all sources of contaminants. Requires high air volumes.



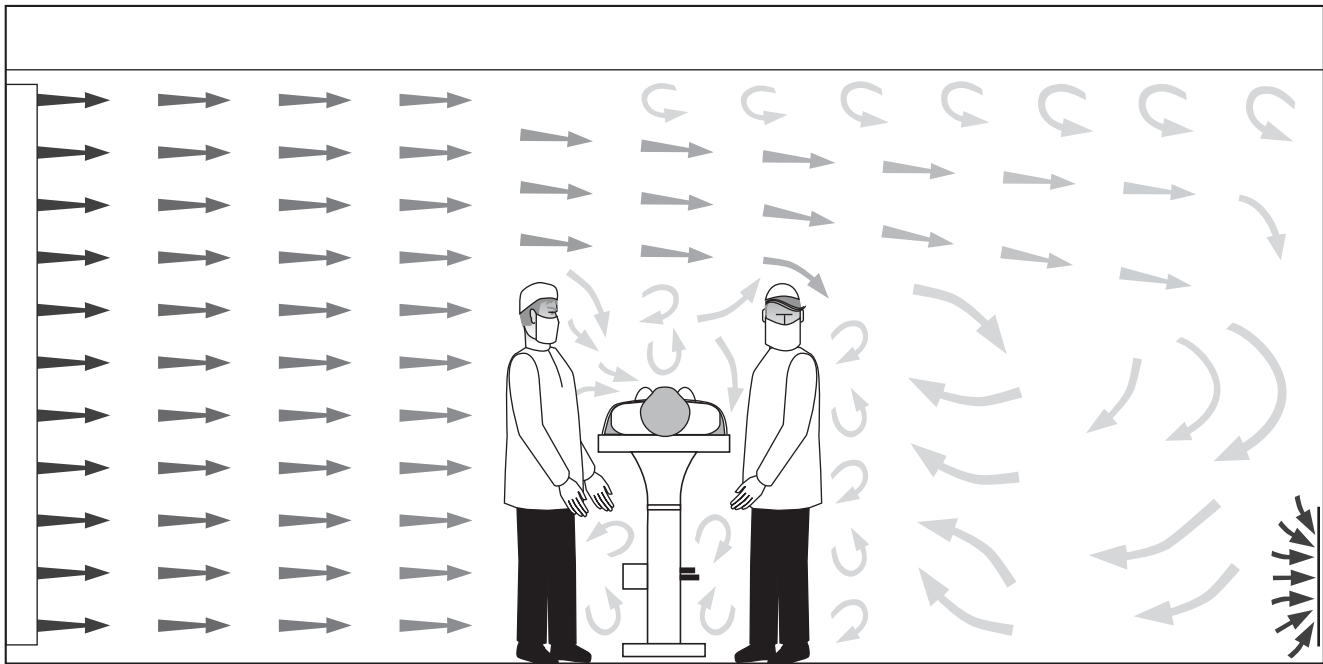
**FIGURE 3:**  
Small Area Laminar Flow System. Marginal protection of the patient from contaminants. Physical movement of personnel can disrupt flow field. Requires low to moderate air volumes.



**FIGURE 4:** Laminar Flow System with Ceiling Hung Deflection Walls. Good protection of the patient from all sources of contaminants. Requires moderate air volumes.



**FIGURE 5:** Laminar Flow System with Perimeter Air Curtain. Good protection of the patient from all sources of contaminants. Requires low to moderate air volumes.



**FIGURE 6:** Horizontal Laminar Flow System. Marginal protection of the patient from all sources of contaminants. Requires moderate to high air volumes.

**THE STERI-SYSTEM SOLUTION**

Engineers, when designing the HVAC system for operating rooms, have many factors to consider. The primary responsibility of all engineers is to protect the public safety, however they must consider the financial implications on their client as well. The goal of the Steri-System project was to provide a system, superior to others in the market, that minimizes the number of airborne contaminants at the surgical site while using only the minimum amount of air imposed by the standards. It also had to be cost effective, easy to install, easy to clean, meet recommended sound levels and be flexible enough to accommodate a wide variety of room layouts and equipment.

These goals were accomplished with the development of two products: the Model Series 92LS-SS Linear Slot Curtain Diffuser and the Model Series 92LFD-SS Laminar Flow Diffuser. By using these products in a modular fashion an incredible array of Steri-System Modules can be created to suit almost any application. The Steri-System Modules are designed to create a clean zone around the patient. This is accomplished by first creating an air curtain around the patient and the surgical staff. The curtain is designed as an invisible barrier to airborne microorganisms. It protects and isolates the clean zone from contaminated room air and personnel that are outside the curtain. The slot on the Model Series 92LS-SS Linear Slot Curtain Diffuser is specifically designed with a fixed pattern deflector to direct the air outwards from the clean zone at a 5 – 15°

angle. The unique wide single slot design minimizes the air turbulence and velocity, and hence the induction of contaminated room air into the curtain airflow, protecting and isolating the clean zone, while the angled deflection “sweeps” particles away from the operating area. Integral pressure plates and multiple inlets ensure uniform distribution of air along the entire curtain length. The face design also incorporates longitudinal deflectors that horizontally deflect a small amount of air lengthwise. This effectively joins the airflow through sections and corners forming a truly continuous air curtain, resulting in enhanced isolation of the surgical area. Removable face panels, held in place with 1/4 turn fasteners, and radiused corners on the plenums ensure that the system is easy to clean. The center section of the system consists of our 92LFD-SS Series Laminar Flow Diffusers. These non-aspirating perforated diffusers provide a low velocity column of downward moving clean air directed at the operating table and patient. The double baffle design incorporates two pressure plates and a disc damper to provide even velocity air distribution over the entire face of the diffuser. With 1/3 of the total system air supplied in this fashion, a slightly positive pressure is created over the operating table resulting in an outward moving mass of clean supply air. The air direction is outward from the centerline of the diffuser bank and helps carry particles generated by the surgical staff away from the patient. The actual number of air changes within the air curtain (see Table 1) and especially over the patient is also greatly



enhanced over that of the entire room. This enhanced air change rate greatly reduces the number of contaminated particles within the clean zone.

Available in many standard and custom sizes, the Nailor Steri-System can accommodate a wide variety of ceiling types and layouts. No system is complete without low level return air grilles and Nailor has a complete selection of stainless steel return grilles for use in this application.

Module Size	Total System CFM Range			Air Changes per hour (ACH) within the Air Curtain		
	Low	Med	High	Low	Med	High
8 x 4	945	1320	1700	59.1	82.5	105.9
8 x 6	1070	1500	1925	44.4	62.5	80.0
8 x 8	1220	1710	2195	38.0	53.4	68.4
10 x 6	1220	1710	2195	40.5	57.0	73.0
10 x 8	1370	1920	2470	34.1	48.0	61.9
10 x 10	1520	2130	2735	30.3	42.6	54.6
12 x 6	1370	1920	2470	37.9	53.3	68.8
12 x 8	1520	2130	2735	31.6	44.4	56.9
12 x 10	1670	2340	3005	27.8	39.0	50.0
12 x 12	1820	2550	3275	25.2	35.4	45.4
14 x 8	1670	2340	3005	29.7	41.8	53.6
14 x 10	1820	2550	3275	25.9	36.4	46.7
14 x 12	1970	2760	3545	23.4	32.9	42.1
14 x 14	2095	2930	3765	21.4	29.8	38.4

**TABLE 1:** This chart shows the enhanced air changes per hour within the clean zone of the Steri-System. Example: For an operating room that has an area of 500 square feet and a 10 ft ceiling, designed for 26 ACH, it would result in a total room airflow of 2167 cfm. This is very close to the midrange airflow of 2130 cfm for a 12 x 8 module. From the chart above, with 1/3 of the airflow supplied through the centre laminar flow panels, we see that the resulting ACH within the clean zone is increased from 26 to about 45.



**FIGURE 7:** Photo shows standard 12 x 8 Steri-System module installed in the Nailor Air Distribution laboratory.

## APPLICATION GUIDELINES

The operating room environment is one of the most critical areas requiring air distribution. Any type of system has to include in its design the ability to isolate contaminants and reduce the risk of infection to the patient. To accomplish this effectively a large volume of clean air must be supplied into the room at relatively low velocities and acceptable noise levels. The high air change rate dilutes the microbiological contaminants present in the room or within the clean zone. A low air velocity is required to allow the heavier particles to settle and be exhausted out as well as reduce the impingement of particles generated by the surgical team onto the patient.

## PERIMETER AIR CURTAIN SELECTION

The goal of the air curtain is to effectively isolate the patient and surgical staff from contaminants present in the operating room. The curtain must also be large enough to contain and accommodate the staff and equipment that are used in the particular procedures being performed. The curtain creates an invisible barrier to airborne microorganisms. To accomplish this effectively we need to select the perimeter air curtain in such a way as to achieve at least 50 ft/min (0.25 m/s) air velocity at the height of the operating table. This will ensure that the air curtain maintains its integrity in the critical areas above the table height. If the system is normally in a cooling mode with a moderate load in the room we need to select the perimeter system for at least 25 cfm per linear foot (39 l/s/m). At this flow rate isothermal air will be at a 50 fpm velocity (0.25 m/s) 5 ft (1.5 m) below the slot diffuser. As the supply air temperature drops in cooling mode the throw of the diffuser will increase. A general rule of thumb would be that for a twenty degree difference in room temperature there is corresponding increase of the throw by 25%. Therefore, under normal cooling conditions, the linear will provide an effective curtain around the operating room

table. If the curtain is selected at the recommended medium airflow value of 35 cfm/ft (54 l/s/m) the resulting isothermal throw increases to 6.5 ft (2 m). For a typical operating room with a ten foot ceiling height and a low cooling load this will be ideal. At the recommended maximum flow rate of 45 cfm/ft (70 l/s/m) the isothermal throw increases to 7 ft (2.1 m), providing additional protection. If heated air is to be supplied through the curtain during surgery, special consideration must be given to the

selection of the linear. The buoyancy effect of the warm air can be substantial and negate the curtain effect provided by the diffuser. Ideally, a mock-up should be performed depending on the specific requirements of the project, however great care should be taken to reduce the leaving air temperatures as much as possible.

## INTERIOR LAMINAR FLOW DIFFUSER SELECTION

Selecting the laminar flow diffusers for optimal performance is a considerably more complicated process. The first thing to consider is the sound levels in the room. The laminar flow diffusers are a significant contribution to the resultant air distribution sound level in the room. The recommended sound range for operating rooms is 25 – 35 RC(N). The laminar flow diffusers produce a neutral range of sound that closely approximates the RC curves in the important 250, 500, 1000 and 2000 Hz octave band center frequencies. As a result we utilize NC values in our analysis. The most important variable in the selection for sound level is the diffuser inlet size. The Nailor 92LFD-SS Series Laminar Flow Diffusers, due to their double baffle design, are somewhat unique in that the inlet size or velocity has little or no effect on the resulting throw or outlet velocity. The inlet size only changes the pressure drop and NC level. Therefore, selection with larger inlets results in a quieter more efficient system. The other thing to consider is that the sound from several identical diffusers side by side is additive logarithmically. This results in an increased NC level as shown in Table 2.

Number of Laminar Flow Diffusers	2	3	4	5	6	8	10
Increase in Noise Level, NC	3	5	6	7	8	9	10

**TABLE 2:** The table above provides an NC addition value useful for estimating room sound levels in applications with multiple laminar flow diffusers of the same size and air volume. For example, if we look at a typical case of 3 laminar flow diffusers in a room (12" inlet, 48 x 24 module at 260 cfm each). From the individual data on page E48 we see an NC value of 18 for one unit. Therefore, from the table, we see that we must add 5 NC to this for an estimate of the total sound level for the 3 diffusers, resulting in NC 23. Selection of the same diffusers with 10" inlets results in an NC value of 30.

Another important aspect of the laminar flow diffuser selection is the static pressure drop and its effect on system balancing. The laminar flow diffusers generally have a much higher pressure drop than the perimeter air curtain. As a result, the perimeter air curtain, or the ductwork supplying it, will in many cases require the use of optional inlet balancing dampers to accommodate the pressure difference. A larger inlet size and/or additional diffusers reduces this difference resulting in less pressure drop across the dampers and a quieter, more efficient system. Many manufacturers provide so-called

self-balancing systems without dampers, that if improperly applied, could result in too little air being supplied through the laminar flow diffusers.

The laminar flow diffuser layout is also critical to the ultimate performance of the system. The diffusers should ideally completely blanket the patient with low velocity laminar airflow. The best results are obtained when the diffusers are directly above the patient as the influence of the surgical staff will be minimized.

While this may interfere slightly with the placement of lighting or other equipment it is critical for optimal performance. With the myriad array of lighting solutions and mounting arms available the diffuser placement should be given priority. Remember the light will shine through the air without any problems and can be adjusted to accommodate people and equipment, however, the airflow cannot be adjusted or directed as easily. The larger the supply area of the diffusers the better the coverage and protection of the patient will be. The air velocity from the diffusers above the patient is also extremely dependent on the supply air temperature. Colder air will throw much further and will, in some instances, actually accelerate resulting in a much higher velocity below the diffuser than the actual outlet velocity at the ceiling line. The actual operating table itself also has a profound effect on the air velocity as this obstruction will cause the air to slow and 'pillow' around and over the table. For best results, in typical applications, we suggest that laminar flow diffusers be selected between 20 and 40 cfm/ft<sup>2</sup> (102 l/s/m<sup>2</sup> and 203 l/s/m<sup>2</sup>) of face area. For example a 24 x 48 (600 x 1200) module laminar flow diffuser should be selected between 160 and 320 cfm (75 and 150 l/s).

## SELECTION OF STERI-SYSTEM MODULE SIZE

The first step in determining module size is to determine the total supply airflow for the operating room. Table 3 summarizes the current guidelines for the various organizations shown.

The most stringent minimum number of air changes is published by ASHRAE and they are generally considered to be the code authority throughout the country. Some areas require a 100% outside air supply system which not only helps to reduce contaminants but can provide additional protection during a fire emergency. Operating rooms are obviously not easy to evacuate during a fire and the combination of a positive pressure and outside air can enhance smoke protection.

Based on these (or other) guidelines, determine the total number of air changes required for the operating room. With this and the room volume we can determine the total airflow to be supplied:

$$\text{Total Room Supply Airflow (cfm)} = \frac{\text{Total Room Volume (ft}^3\text{)} \times \text{\# of Room ACH}}{60}$$



We must then confirm that this airflow will fulfill the other requirements of the room, such as cooling load and humidity requirements, as well as maintaining the pressure relationships with the adjoining areas. Some systems must be capable of quickly reducing or increasing the room temperature and humidity during or between procedures and/or maintaining a lowered design set point temperature of 60 – 65°F (16 – 18°C) during procedures. Also, best air distribution and comfort conditions are generally obtained when the supply air temperature differential during surgery is small and relatively constant. When the total room airflow is determined we can choose our Steri-System module size. From the chart on page E83 the total system airflow ranges and noise levels are shown. The system should be selected within the ranges shown on the chart with consideration as to final module size and its ability to accommodate the personnel and equipment as necessary. The standard systems shown have been designed to simplify the selection and layout process while providing maximum protection to the patient within the airflow ranges shown. The interior and perimeter pressure and flow relationships are maintained with 1/3 of the airflow being supplied through the laminar flow center panels and the remaining 2/3 through the perimeter curtain diffusers. Inlet sizes and air volumes per inlet have been designed to minimize sound and

pressure drop and enhance system efficiency. The standard modules shown are only a small fraction of the possible combinations available and are sized to meet the most common conditions. If your particular requirements cannot be met with the standard module sizes, other combinations of laminar flow diffusers and/or perimeter curtains are available. Please contact your local Nailor representative for assistance on your particular application.

Source	Room Types	Minimum Air Changes/Hour ACH	Minimum Outside Air ACH	Minimum Filtration Efficiency
ASHRAE 2003 Handbook HVAC Applications	Operating Room Cystoscopic Rooms Delivery Room	25	5	Merv 17 (99.97%) for Orthopedic, Bone Marrow and Organ Transplant. Merv 14 (90%) for General Procedure and Delivery Rooms.
American Institute of Architects 2001 Edition Guidelines for Design & Construction of Hospital & Health Care Facilities	Operating/Surgical Cystoscopic Rooms Delivery Room Trauma Room Procedure Room	15	3	90%
	Bronchoscopy, Triage, ER or Radiology Waiting Rooms	12	3	
	Endoscopy	6	2	
Canadian Standards Assoc. CSA Standard Z317.2-01 September, 2001	Operating Rooms Endoscopy, Bronchoscopy, Cystoscopy, PACU, Surgical Day Care, Caesarean Delivery	20	6	99.97%

**TABLE 3:**

This table summarizes some of the current recommendations for operating room ventilation rates. Consult the actual documents for specific requirements and exceptions.

## SELECTION OF RETURN/EXHAUST AIR OUTLETS

The return or exhaust outlet of the operating room is the final part of any system design. Codes require a minimum of two outlets located at low level (at least 3 inches above the floor) generally on either side of the room. These grilles are selected for approximately 85% of the supply airflow so as to maintain positive room pressurization. It is recommended that they be selected for an NC level of 25 or less so as to not contribute to the overall room sound level. The return grille selection and placement has very little effect on the resultant airflow patterns within the room. It is important to note that exhaust grilles do not 'suck in' the surrounding room air and create airflow patterns. The airflow is only affected within a few inches of the grille face. (The old air distribution adage is that you can't suck out a match, but you can blow it out). The low level placement of the grilles does aid in the removal of the heavier particles and discourages their settling on the floor or recirculation. Nailor offers two standard and several custom models for this application. The two standard models are 67FB45 and 67FB55. Both are identical with fixed 45° blades except that they have 3/4" and 1/2" blade spacing, respectively. The choice of blade spacing is really only an appearance issue as both designs meet all applicable requirements. The 3/4" model has a greater free area and therefore the resultant size will be somewhat smaller. The grilles are available in either 304 or 316 stainless steel and compliment the appearance and construction of the Steri-System components. The grille core is held in place with 1/4 turn fasteners to allow for complete removal and disinfection, as well as full access to the ductwork beyond. Special options available include perforated or eggcrate grille cores, filter clips for disposable 1" or 2" media filters or mounting frames for Gel Seal HEPA filters. These special options are not recommended in the operating room, however they are useful in other areas and applications.

## SELECTION EXAMPLE

Design Criteria: General Procedure Operating Room  
 Room Size: 20 ft wide x 25 ft long x 10 ft ceiling height  
 = 5000 ft<sup>3</sup> Room Volume  
 Minimum: 8 ft x 8 ft Clean Zone Required  
 Supply Air Temperature: 55°F  
 Room Temperature Set Point Range: 62 – 80°F  
 Airflow: Minimum 25 ACH (recirculating system) –  
 Positive room pressure  
 Sound Level: 25 – 35 NC

Calculate required room airflow rate:

$$\text{Airflow (cfm)} = \frac{\text{Room Volume (ft}^3\text{)} \times \text{ACH}}{60}$$

$$\text{Airflow (cfm)} = 5000 \times 25/60 = 2083 \text{ cfm}$$

We must then confirm that this airflow will meet the maximum cooling load requirement for the room (not shown). Note the room temperature must be able to be maintained at the lowest specified temperature for some procedures (62°F in this example). With a 55°F supply air temperature the load may, in some cases, require an increase in airflow to compensate for the low ΔT between supply air and room temperature. Also some procedures may require the system to quickly reduce or increase the room temperature and humidity during or between procedures. One of the features of the Steri-System design concept is the creation of a micro-climate within the clean zone. The enhanced air change rate within the curtain (Refer to Table 1 in the Engineering Section) and the use of non-aspirating Laminar Flow Diffusers create a room within a room effect. An analysis of the cooling load within the air curtain should be considered for critical projects. Obviously, for the 80°F set point, the reheat coil and modulating valve must be sized accordingly. (Refer to the Nailor VAV Terminal Units catalog for more information on reheat coil selection).

From the selection chart we see that the airflow falls midrange for a 12 x 8 Steri-System module size which meets our minimum specified clean zone size.

From the module layout page we have all the pertinent dimensions, as well as recommended inlet sizes and airflows. This should be coordinated with the desired ceiling layout for surgical lighting, utility columns, monitors and equipment, etc.. Several different module sizes will meet the specified criteria and the choice will generally depend on the layout. (Placement of diffusers above the table should take priority over placement of light fixtures).

Also, from the selection chart, we find a system NC level of 26 which falls well within the recommended sound levels. Therefore, a standard 12 x 8 Module Steri-System will meet our criteria for this example.

For return air grille sizing and room pressurization we will use the recommended 85% of the supply air total and a minimum of two inlets.

Therefore:

$$\begin{aligned} \text{Total Return Air} &= \text{Supply Airflow} \times 0.85 = 2083 \times 0.85 \\ &= 1770 \text{ cfm total} \\ \text{or for two inlets} &= 885 \text{ cfm each} \end{aligned}$$

For a standard Model 67FB45 and sizing for low sound and pressure drop we find that two grilles 18" x 18" (or equivalent size) will be sufficient, resulting in a low noise level (< NC 20) and pressure drop (< 0.1" w.g.).

## HEPA AND ULPA FILTERS

**Nailor** provides the highest quality filters currently available. We provide HEPA and ULPA filters as options in our stainless steel laminar flow and radial flow diffusers. Typical applications include hospitals, semiconductor manufacturing, disk drive and compact disc manufacturing, food processing, pharmaceutical production and aerospace manufacturing.

Our standard filters incorporate an anodized aluminum Gel Seal frame that mates with a specially constructed 'knife-edge' frame on our diffusers to provide a leak-tight connection. The filters also utilize a separatorless 2" (51) deep media pack as standard and we provide a removable test port integral with every filter. The test port is used to measure filter pressure drop, perform leakage (scan) tests or to adjust balancing dampers in the diffuser neck.

All filters are UL 900 Class I Listed and Factory Mutual Approved. All filters are individually scan tested per Section 6.2 of IEST-RP-CC034.1. Filters are packaged independently from the diffuser for final installation of the filter in the field (by others). ULPA filters are assembled and tested in a cleanroom environment before being sealed in a polybag.

### FILTER SELECTION AND APPLICATIONS

Most people are commonly aware of the extremely high filtration offered by these filters, however proper application requires an understanding of the test methods and ratings.

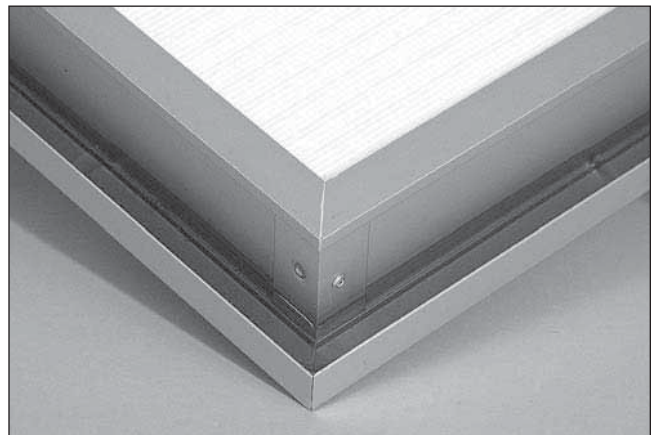
The standard ratings are as follows:

- HEPA filters have 99.99% minimum removal efficiency on 0.3 micrometer particle size.
- ULPA filters have 99.9995% minimum removal efficiency on 0.12 micrometer particle size.

It is very important to realize that the testing is done with an aerosol of specially constructed man-made spheres not with biological or irregular shaped particles. This is necessary to provide a repeatable test and ensure manufacturing quality, however, depending on the applications and conditions involved actual efficiency may be somewhat lower. Recent studies with biological particles indicate that they may migrate of their own accord through the filters over time. This can be explained due to the fact that some bacteria have flagella which enable movement and possible detachment from filter fibers, also some bacteria are surrounded by gelatinous surfaces (slime), which may reduce filtration efficiency. Some fungal spores and bacteria will grow in the presence of moisture and could grow through the filter elements over time.

Another important thing to note about filters is their most penetrating particle size range. The filtration efficiency of filters follows a specific nonlinear curve. Classification of HEPA filters is their efficiency at a particular diameter of

particle (0.3 micrometers and larger). Generally a smaller diameter particle, say 0.2 micrometers, will have a slightly lower filtration efficiency which could also depend on air velocity. Many of the pathogens responsible for nosocomial infections have particles in this size range. It is important to note that many pathogens that are attached to larger particles or are found in clumps will break apart upon contact with the filter fibres. Therefore it is recommended that actual particle size be used to determine a conservative filtration efficiency requirement. Also, the testing is performed at 100 fpm (0.51 m/s) velocity on the net media face area. Table 4 gives the net media face area of our standard filters and the recommended airflows. The filters have been shown to maintain their ratings at up to 150 fpm (0.76 m/s) velocity and 2" (50 Pa) pressure drop and this is the maximum shown in the chart and our performance data. Once again, exceeding these criteria could reduce filter efficiency. Also, particles are typically not evenly deposited on the filter and there could be localized areas on the filter that will exceed the maximum velocity as the filter gets dirtier.



**FIGURE 8:** Photo shows standard Gel Seal HEPA Filter. Standard construction is an anodized aluminum frame with a separatorless 2" (51) deep media.

Ceiling Module Size	Net Media Face Area		Recommended Max. Airflow		Maximum Airflow	
	(ft. <sup>2</sup> )	(m <sup>2</sup> )	(cfm)	(l/s)	(cfm)	(l/s)
<b>Imperial Ceilings (inches)</b>						
48 x 12	1.93	0.179	193	91	290	137
60 x 12	2.50	0.232	250	118	375	177
24 x 24	1.96	0.182	196	92	294	139
36 x 24	3.37	0.313	337	159	506	239
48 x 24	4.77	0.443	477	225	716	338
60 x 24	6.17	0.573	617	291	926	437

Ceiling Module Size	Net Media Face Area		Recommended Max. Airflow		Maximum Airflow	
	(ft. <sup>2</sup> )	(m <sup>2</sup> )	(cfm)	(l/s)	(cfm)	(l/s)
<b>Metric Ceilings (mm)</b>						
1200 x 300	1.89	0.176	189	89	284	134
1500 x 300	2.45	0.228	245	116	368	173
600 x 600	1.87	0.174	187	88	281	132
900 x 600	3.22	0.299	322	152	483	228
1200 x 600	4.56	0.424	456	215	684	323
1500 x 600	5.91	0.549	591	279	887	418

**TABLE 4:**

This table gives net media face area of the standard HEPA and ULPA Filters. The recommended maximum airflow shown is based on 100 ft/min (0.51 m/s) velocity and the maximum airflow is based on 150 ft/min (0.76 m/s) velocity.

## DISINFECTION, STERILIZATION AND MATERIALS

The subject of disinfection and sterilization in healthcare facilities (like most healthcare related issues) is extremely controversial. Most authorities do not agree on the type, frequency or effectiveness of the various methods and chemicals. The result is that many hospitals use many different methods and new research and product developments continue to influence actual practices. The evolving trend seems to be towards stricter controls and higher levels of disinfection. Newer construction guidelines focus on surfaces that are resistant to harsh cleaners, have no cracks or crevices and are easier to clean, such as monolithic ceilings in operating rooms, etc..

The sanitation requirements in the operating room are the most severe as they are aimed at total asepsis. This requires the use of strong cleaners, usually highly alkaline soaps reinforced with synthetic detergents. In addition to meeting the regular standards of cleanliness, the general cleaning is supplemented with sanitizers, disinfectants and sterilants. These chemical formulations are functional against different levels and types of contamination. Sanitizers reduce, but not necessarily eliminate microorganisms. These cleaners contain lye (caustic soda, sodium hydroxide) and alkaline hypochlorites (equivalent to bleach). Often these and other cleaning and sanitizing agents will have the alkaline salts aided by 'quats' (quaternary ammonium derivatives). Disinfectants go one step further than sanitizers in that they eliminate all pathogenic

microorganisms, that is, they destroy infectious fungi, viruses and bacteria, but not necessarily their spores. These agents may also contain 'quats' such as quaternary ammonium chloride or phenolics (carbolic acid derivatives) with the addition of detergents, either soaps, surfactants or both. Some of these agents, especially in concentrated form, are in an alkaline solution and have an extremely high pH level 12.5 – 13.8 (similar to paint stripper or concentrated lye). Sterilants cap the assault on disease producing agents. They destroy all forms of microbial life and their spores. Complete sterilization of environmental surfaces is not possible or practical in health care facilities however, and many sterilants are used as high level disinfectants. They include acids such as phenol (carbolic acid), citrosols (buffered citric acid), phenolic derivatives such as hexachlorophene and peracetic acid/hydrogen peroxide. On the alkaline side they include lye, terpenes, high pH germicides and glutaraldehydes.

It is easy to see that most of the above chemicals will be corrosive to metals, especially those containing chlorine compounds. Most metals typically used in HVAC systems are carbon steels protected by sacrificial coatings such as zinc, zinc alloys or aluminum. Aluminum sheet and aluminum extrusions are also commonly used. Aluminum and the coatings used to protect carbon steel are amphoteric, which means that they are attacked (corroded) by alkalis and acids. Therefore any agents with a pH lower than 7 (acidic) or higher than 7 (alkaline) are corrosive to these surfaces. It is important to understand that metallic materials do not corrode evenly or uniformly.



Instead, corrosive attack occurs at anodic sites while protecting cathodic sites on the metal surface. The energy of corrosion is the difference of potential between different parts of the surface, like between grain boundaries or between different alloying elements, such as reactions of dissimilar metals in contact with each other. This corrosion results in pitting and the formation of insoluble corrosion products. Aluminum alloy pitting is accompanied by a residue of a corrosion product that is usually white, rough or granular, aluminum hydroxide/aluminum carbonate (the carbon dioxide in the atmosphere reacts with the aluminum hydroxide to make the carbonate). By the same mechanism zinc and zinc rich coatings leave a corrosion product of basic zinc carbonate (white rust). Surfaces that are pitted or roughened by corrosion product residues are ideal for entrapment of and colonization by bacteria, fungi and spored.

Superior materials for HVAC system components are austenitic stainless steels such as Type 304 (18% Chromium, 8% Nickel) or even more corrosion-resistant Type 316 (18% Chromium, 8% Nickel, 2 – 3% Molybdenum). These alloys are used for many other hospital applications including instruments, equipment and even implants. The U.S. Army and the Department of Veterans Affairs (the largest operators of hospital facilities in the world) recommend all stainless steel HVAC components downstream of the final filters in operating rooms. Another inherent advantage of 304 and 316 stainless steels is the fact that they are non-magnetic. With the incredible advances in imaging technologies such as MRI (magnetic resonance imaging) and the ever increasing applications for surgery, the use of non-magnetic materials in operating rooms could have future potential benefits.

Surface finish of the metal is very important as it should be as smooth as possible to avoid retention of microscopic microorganisms and to facilitate cleaning. Nailor Industries standard construction of stainless steel diffusers, components and fasteners in this catalog utilize Type 304 stainless steel as standard (Type 316 is optional on all products and standard on most fasteners) with a #3 satin polished finish on exposed surfaces and a 2B finish on unexposed surfaces. The 2B finish on the plenum interiors, etc. has a low surface roughness value. The #3 polish, while it is considerably more rough, is used for aesthetic concerns to provide a uniform appearance after manufacturing processes. Other finishes and polish grades are available options, including electrolytic polishing and passivation treatments. Wherever economically possible products are designed to facilitate cleaning with features such as removable components, rounded edges, minimal numbers of joints, fasteners and welds etc.. When 304 or 316 stainless steels are welded there is an area near the weld that becomes heated to between 1000°F and 1300°F (550°C and 700°C). In this temperature range carbon reacts with the chromium to produce complex chromium carbides. The result of this is that the metal in

the vicinity of the weld becomes depleted in chromium and therefore becomes an anodic site on the material. These sites, in some instances, can be hundreds of times less corrosion-resistant than the unaffected metal. During welding the surface of stainless steel can also be affected by several other factors including slag material from coated electrodes, heat tint, weld flux, arc strikes, weld stop points and weld spatter. Grinding afterwards and other mechanical cleaning processes can sometimes do more harm than good. They can also overheat the surface, create surface crevices, microcracks, scratches, burrs and deposit contaminants. These factors will substantially reduce the corrosion resistance of the material. They also increase the surface roughness in the vicinity of the weld, greatly reducing its cleanability. Various pickling, passivation or electropolishing treatments are available to help restore the material after welding, however these are typically not performed on welded HVAC components due to the costs, time and chemicals involved. Where possible, Nailor stainless steel products are mechanically fastened together with rivets or other fasteners to help maintain the integrity of the material and enhance its cleanability and corrosion resistance. Before shipping, each product undergoes a cleaning process where it is washed in a 20% alkaline solution, rinsed with clear water and exposed to a de-ionized water mist, all at an elevated temperature of 140°F (60°C). This process removes the oil, grease and surface contaminants inherent in the manufacturing processes. It is not intended as a disinfectant. We recommend that all products should be fully disinfected after installation.

## SYSTEM TESTING

Testing any operating room system is a very controversial process. There are no common standards to test to and many factors can influence the results. There are, however, some very important tests that can be performed that will give the engineers and infection control personnel valuable information and help in diagnosing potential problems.

Most tests in operating rooms are typically looking for cfu concentration (colony forming units) generally expressed as cfu/ft<sup>3</sup> (cfu/m<sup>3</sup>). These tests generally do not determine the specific type of microbiological contaminants present. In some instances this will be very important and should be performed especially as part of an epidemiological investigation. In cleanrooms, generally all particles of a specific size are counted including the microbiological ones. To understand the value of these test results we must first look at the nature of the contaminants involved and their likely sources. To fully consider the myriad assortment and quantity of different viruses, bacteria and fungi, as well as their various properties, is truly a daunting endeavor for any HVAC engineer and well outside the scope of this text. We can however make a few assumptions, that will in most cases be correct, and will provide valuable information.

Outdoor air generally contains high concentrations of fungal spores often exceeding 28 cfu/ft<sup>3</sup> (1000 cfu/m<sup>3</sup>) during the summer. Dry, windy conditions will stir up soil and release the contaminants. In winter, especially with snow covered ground, it can be considerably lower, 2.8 cfu/ft<sup>3</sup> (100 cfu/m<sup>3</sup>) or even less. Samples of outdoor air rarely contain high concentrations of viruses or bacteria that are pathogenic (harmful to humans) unless there is a specific source nearby. Outdoor conditions such as sunlight, high or low temperatures and even oxygen will kill most pathogenic viruses or bacteria. Other non-pathogenic viruses or bacteria are present in the air in varying quantities sometimes as high as 28 cfu/ft<sup>3</sup> (1000 cfu/m<sup>3</sup>).

If we consider the simple case of an unoccupied operating room with 100% outdoor air supplied to it. If the room has been unoccupied for a few hours before the test we can generally assume that all pathogenic particles will have been removed with even a low air change rate (15 ACH). Therefore unless the room itself or the equipment within it are contaminated sources, which is unlikely, we can assume the number and type of particles are directly related to the outdoor air and the filtration efficiency. This is a valuable measurement to take, generally after final commissioning and before the room is actually used. It can provide a good background level to compare future tests against and allow monitoring of the filter performance. Care must be taken, however, in the interpretation of the results. High numbers of spores may indicate contamination of air handling system components prior to or during installation, or a system deficiency such as improperly sealed filter frames when culture results are compared to known filter efficiencies and rates of air exchange.

Many HVAC systems will also use a return air component (up to 80%) in the total air supplied to the operating room. If the unoccupied room is tested with maximum return air it will give an indication of the contaminants present in the return air or the associated return air ductwork. If the hospital is fully occupied and functioning there will probably be pathogenic particles present and the analysis of them could help in determining potential sources of infection.

Testing an occupied operating room to determine the effectiveness of the air distribution system and its ability to isolate and remove contaminants is an extremely complex process. Most authorities agree that the major source of microbiological particles in the operating room air is the surgical team and the patient. A person releases about 10 million particles per day. The release rate is about 10,000 particles/min. while walking. Rate of movement, air velocity, humidity, clothing type and surgical mask filters can greatly affect particle release rates. Even things such as sneezing, coughing and talking will have an effect. About 5 – 10% of the particles which range in size from 2.5 – 20 µm carry bacteria.

Staphylococci aureus is the most common cause of surgical site infection. People are classified as dispersers

of an organism if its proportion exceeds 1% of the total disseminated bacteria. In one study 9 – 13% of men and 1 – 1.5% of women were found to be dispersers of *S. aureus*. Another important cause of surgical site infections is coagulase-negative staphylococci, which accounts for approximately 14% of surgical site infections, such as *S. epidermis* and its methicillin resistant strain MRSE. A recent Swedish study indicated that as many as 43% of male and 25% of female operating room staff were dispersers of MRSE. MRSE was also detected in the air of the operating room in spite of a very high ventilation rate of 80 ACH.

Therefore it must be realized that testing an operating room that is occupied will depend on the number of people in the room, the specific people themselves including the patient and whatever bacteria that they may or may not be dispersing. Many manufacturers, including Nailor, try to make claims as to the superior nature of their systems over that of their competitors. This is virtually impossible to prove as there are no common standards for us to test to. Most manufacturers have tested to different standards and under different conditions. Several, so-called mock-up conditions have been tested, however, each manufacturer used different conditions. Any test results will be influenced by many factors including the surgical attire, number of people, amount of motion in the space, type and duration of the operation, room size, air flow rates, outside air/duct contaminants, filtration efficiency, type and size of particle being counted, outdoor air quality and volume, incubation periods and properties of the specific particles, sampling intervals, sample locations, type and accuracy of samplers, various strains of particles, temperature, humidity, time of day or year, etc.. All of these factors must be addressed, controlled and recorded to obtain meaningful results and allow comparisons.

The next thing to consider is that after all these factors have been addressed and the amount and type of contaminant has been determined we must then ascertain if it is at an acceptable level. There are many studies and recommendations as to the amount of particles present that are required to produce an infection. Most of them disagree with each other and there is a lack of true empirical data. One study suggests that a total microbial level of 0.28 cfu/ft.<sup>3</sup> (10 cfu/m<sup>3</sup>) for orthopedic and 2.8 cfu/ft.<sup>3</sup> (100 cfu/m<sup>3</sup>) for general surgery be adopted as the maximum limits. Another study suggests fungal sampling be performed in the rooms of immunocompromised patients and in operating rooms and a limit of 0.42 cfu/ft.<sup>3</sup> (15 cfu/m<sup>3</sup>) for total viable spore concentration and a limit of 0.0028 cfu/ft.<sup>3</sup> (0.1 cfu/m<sup>3</sup>) for *Aspergillus* (invasive aspergillosis has a very high fatality rate, approximately 75%, due to the limited effectiveness of antifungal therapy). No recommendations are given for bacterial or viral microorganism particulate evaluation. Bacterial microorganisms are the most common sources of surgical site infections.

Ethical considerations are also an important factor that results in the lack of empirical data from real world testing. Most people would agree that it is unethical to test actual filtration efficiency with live bacteria or viruses, or to try different air change rates to see their effect on infections in a hospital.

The manufacturer shall provide published performance data for the system, which shall be tested in accordance with ANSI/ASHRAE Standard 70 – 2006.

## SUGGESTED SPECIFICATION

Furnish and install **Nailor STERI-SYSTEM Model 92STSYS Hospital Operating Room Air Systems** of the size and type shown on the plans and air distribution schedules. The system shall be specially designed to reduce airborne contaminants, and thus, the risk of patient infection during surgery. The system shall be composed of two main components Model 92LFD-SS Laminar Flow Diffusers and Model 92LS-SS Linear Slot Diffusers constructed as follows:

The Laminar Flow Diffusers shall be constructed entirely from 304 stainless steel (316 optional), minimum 24 gauge. The perforated face of the diffuser shall have 13% free area with 3/32" (2.4) dia. holes on 1/4" (6) staggered centers. The face shall incorporate a second pressure plate as an integral assembly to ensure true laminar airflow. The face shall be attached with 1/4 turn fasteners to allow for complete removal and access to the interior for cleaning. All diffusers are to include safety cables to prevent accidental dropping of the removable face. A disc type damper, adjustable from the face of the diffuser, shall be provided with all units. Integral earthquake hanger tabs shall be included with all units.

The Linear Slot Diffusers shall be constructed entirely from 304 stainless steel (316 optional), minimum 24 gauge. The diffuser shall incorporate a non-adjustable single slot designed to create a vertical air curtain angled outwards 5 – 15°. The diffuser shall incorporate a pressure plate behind the slot to ensure uniform slot velocity. The pressure plate shall be 13% free area with 3/32" (2.4) dia. holes on 1/4" (6) staggered centers. The slot and pressure plate shall be attached with 1/4 turn fasteners to allow for complete removal and access to the interior for cleaning. The plenum shall incorporate radiused corners lengthwise to facilitate cleaning. Flanged plenum inlets are to be maximum 5" (127) in height to allow duct clearance over standard light fixtures. Plenums over 7 ft (2134) in length shall be supplied in multiple sections with flange connections and stainless steel fasteners for field assembly. All diffusers are to include safety cables to prevent accidental dropping of the removable face. Integral earthquake hanger tabs shall be included with all units.

(Optional) An opposed blade damper, adjustable from the face of the diffuser, shall be provided on all perimeter inlets. Dampers shall be held in place with wing nut fasteners and be removable from the face of the diffuser.

All exposed surfaces shall have a #3 satin polished finish.



**SUGGESTED REFERENCES AND RECOMMENDATIONS SUMMARY**

The following references should be consulted before any design is commenced. These references are selected to represent the most current and widely accepted recommendations available from the most respected sources. These summaries are for quick reference purposes only and are not intended to be used as a source of design information.

**1) ASHRAE HANDBOOK  
2003 HVAC APPLICATIONS  
CHAPTER 7 – HEALTH CARE FACILITIES**

**COMMENTS**

Excellent source for general design information.

**HIGHLIGHTS**

Laminar airflow has shown promise in rooms used for treatment of patients that are highly susceptible to infection.

The unidirectional laminar airflow pattern is commonly attained at a velocity of 0.35 to 0.55 m/s (70 to 110 ft/min).

Surgery and critical care areas require careful design to reduce to a minimum the concentrations of airborne organisms.

The greatest amount of bacteria found in the operating room comes from the surgical team and is a result of their activities during surgery.

Studies and observations indicate that the delivery of air from the ceiling, with a downward movement to several exhaust outlets located along the walls, is probably the most effective air movement pattern for maintaining the concentration of contamination at an acceptable level.

System should maintain positive pressurization at all times, even under periods of reduced air volumes, to maintain sterile conditions.

**SELECTED RECOMMENDATIONS**

Surgical, Delivery and Critical Care Areas

- 1) Temperature set point should be adjustable by the surgical staff over a range of 62 – 80°F (17 – 27°C).
- 2) Relative humidity should be kept between 45 and 55%.
- 3) Air pressure should be maintained positive with respect to any adjoining rooms by supplying excess air. Differential pressure between space and corridors should be a minimum of 2.5 Pa (0.01" w.g.).
- 4) Pressure indicating devices should be installed to permit pressure readings in the rooms.
- 5) Humidity indicator and thermometer should be located for easy observation.

- 6) Filter efficiencies as follows:
  - Orthopedic, bone marrow transplant and organ transplant operating rooms:  
2 filter beds , efficiencies of MERV 8 and MERV 17.
  - General procedure operating rooms, delivery rooms etc.:  
2 filter beds, efficiencies of MERV 8 and MERV 14.
 Refer to Handbook for more details.
- 7) All air should be supplied at the ceiling and exhausted near the floor. Bottom of exhaust outlets should be at least 3 inches (75 mm) above the floor. Supply diffusers should be of the unidirectional type. High induction ceiling or sidewall diffusers should be avoided.
- 8) Acoustical materials should not be used as duct linings unless 90% efficient filters are installed downstream of the linings. Internal insulation of terminal units may be encapsulated with approved materials.
- 9) Sufficient lengths of water-tight, drained stainless steel duct should be installed downstream of humidification equipment to assure complete evaporation of water vapor before air is discharged into the room.
- 10) Refer to Table 3 in the handbook for specific ventilation and pressure relationships. Operating room (recirculating air system), operating/surgical cystoscopic rooms and delivery rooms; minimum total 25 air changes per hour with a minimum of 5 air changes of outdoor air.

**AVAILABILITY**

Copies of this document can be ordered from the ASHRAE Bookstore online at [www.ashrae.org](http://www.ashrae.org)

**2) AMERICAN INSTITUTE OF ARCHITECTS  
GUIDELINES FOR DESIGN AND  
CONSTRUCTION OF HOSPITAL AND HEALTH  
CARE FACILITIES, 2001 EDITION**

**COMMENTS**

A very useful document, written in code language, for overall construction guidelines. References CDC/ASHRAE guidelines for specific ventilation requirements.

**HIGHLIGHTS**

Continual health care facility upgrade through renovation and new construction of hospital facilities can create conditions that are hazardous to patients. Design and planning for such projects shall require consultation with infection control professionals and safety personnel, with documentation obtained to verify consultation. Early involvement of these professionals is required for an "Infection Control Risk Assessment" (ICRA).

An ICRA should be performed by a multidisciplinary panel with expertise in infectious disease, facility design and construction, ventilation, epidemiology and safety.

The ICRA shall address but not be limited to the following key elements:

- a) the impact of disrupting essential services.
  - b) patient placement and relocation.
  - c) placement of effective barriers to protect susceptible patients from airborne contaminants such as *Aspergillus* sp..
  - d) air handling and ventilation needs in surgical services, airborne infection isolation and protective environment rooms, laboratories, local exhaust systems for hazardous agents and other special areas.
  - e) determination of additional numbers of airborne infection isolation or protective environment room requirements.
  - f) consideration of the domestic water system to limit *Legionella* sp. and waterborne opportunistic pathogens.
- Control for clean to dirty airflow, interruption of utility and/or building equipment services and communication requirements shall be specified in the project bid documents.

Commissioning acceptance criteria for mechanical systems shall be specified. Crucial ventilation specifications for air balance and filtration shall be verified before owner acceptance. Areas requiring special ventilation include surgical services, protective environments, airborne infection isolation rooms, laboratories, and local exhaust systems for hazardous agents. These areas shall be recognized as requiring mechanical systems that ensure infection control, ventilation deficiencies shall not be accepted.

### SELECTED RECOMMENDATIONS

Airborne infection isolation rooms and protective environment rooms shall have a device to monitor either pressure or differential airflow and shall activate a local alarm in the event the desired status is no longer present. Protective environment rooms shall have a positive pressure with respect to adjoining spaces with all supply air passing through HEPA filters.

Psychiatric patient occupied areas shall have all air grilles and diffusers of a type that prohibits the insertion of foreign objects and all exposed fasteners shall be tamper-resistant.

General operating rooms shall have minimum clear area of 400 square feet (37.16 square meters).

Operating rooms for cardiovascular, orthopedic, neurological and other special procedures that require additional personnel and/or large equipment shall have a minimum clear area of 600 square feet (55.74 square meters).

Operating rooms for surgical cystoscopic and other endo-urologic procedures shall have a minimum clear area of 350 square feet (32.52 square meters).

Outpatient operating rooms have different (smaller) dimensions and classifications. Refer to guidelines for more information.

Ceiling finishes in restricted areas such as operating rooms and other rooms where open wounds are present shall be monolithic, scrubbable and capable of withstanding harsh chemicals. Cracks or perforations in these ceilings are not allowed.

Duct linings exposed to air movement shall not be used in ducts serving operating rooms, delivery rooms, LDR rooms, nurseries, protective environment rooms and critical care units. This requirement shall not apply to mixing boxes and acoustical traps that have special coverings over such lining.

All operating and delivery rooms shall have individual temperature control and systems must operate at all times. Air supply for operating and delivery rooms shall be from ceiling outlets near the center of the work area. (Design should consider turbulence and other factors of air movement to minimize the fall of particulates onto sterile surfaces).

Each operating or delivery room shall have a minimum of two return or exhaust openings located at least three inches above the floor and as remote from each other as possible. Supply and return/exhaust rates shall be controlled to maintain airflow from clean to less clean areas.

Airborne infection isolation rooms shall not be served by devices incorporating a heat wheel.

Provisions shall be made to allow field testing and certification of all HEPA filters.

Table 2 in the guideline provides ventilation requirements for areas affecting patient care in hospitals and outpatient facilities.

### OPERATING/SURGICAL CYSTOSCOPIC ROOMS AND DELIVERY ROOMS:

- 1) Positive pressure with relation to adjacent areas. (minimum of 0.01" water gage 2.5 Pa)
- 2) Minimum of 15 total air changes per hour.
- 3) Minimum of 3 air changes per hour of outside air.
- 4) Air can only be recirculated if it passes through a HEPA filter (refer to guidelines for some exceptions and more details).
- 5) Relative humidity between 30 – 60%.
- 6) Design temperature 68 – 73°F (20 – 23°C). Some surgeons may require temperatures outside of this range. All operating room design conditions should be developed in consultation with surgeons, anesthesiologists and nursing staff.
- 7) Number of air changes can be reduced during unoccupied times, however, provisions must be made to reestablish any time the area is being utilized and the direction of air movement (pressurization) must be maintained at all times.

### AVAILABILITY

Copies of this document can be ordered from the American Institute of Architects Bookstore online at [www.aia.org](http://www.aia.org)

### 3) GUIDELINE FOR PREVENTION OF SURGICAL SITE INFECTION, 1999 HOSPITAL INFECTIONS PROGRAM

NATIONAL CENTER FOR INFECTIOUS DISEASES  
CENTERS FOR DISEASE CONTROL AND PREVENTION  
PUBLIC HEALTH SERVICE  
US DEPARTMENT OF HEALTH AND HUMAN SERVICES

This is the most recent guideline from the Centers for Disease Control and Prevention and presents their recommendations for the prevention of surgical site infections. It updates and replaces previous guidelines.

#### COMMENTS

Probably the most comprehensive source available for medical information and causes of infections in operating rooms. HVAC information is very current with research findings.

#### HIGHLIGHTS

Currently in the United States alone, an estimated 27 million surgical procedures are performed each year.

The CDC's National Nosocomial Infections Surveillance (NNIS) system over a ten-year period (1986 – 1996) reported 15,523 surgical site infections (SSI's) following 593,344 operations (2.6%).

Of these SSI's approximately two thirds were confined to the wound or the incision and the remaining one third were considered deep SSI's involving organs or spaces accessed during the operation.

A 1992 analysis showed that each SSI resulted in an additional 7.3 postoperative hospital days adding \$3,152 in extra charges. Deep SSI's are associated with even greater increases in hospital stays and costs.

When patients with SSI's died, 77% of the deaths were reported to be related to the infection and the majority (93%) were serious infections involving deep SSI's.

SSI's remain a substantial cause of morbidity and mortality among hospitalized patients due to the emergence of antimicrobial-resistant pathogens, increased number of patients that are elderly and/or have a variety of chronic, debilitating or immunocompromising underlying diseases. Also increased numbers of organ transplant and prosthetic implant operations.

Operating room air may contain microbial-laden particles and has been shown as a transmission route of infection to the patient. The microbial level in the room air is proportional to the number of people moving about in the room.

All ventilation or air conditioning systems in hospitals, including those in operating rooms, should have two filter beds in series, with efficiency of the first filter bed being  $\geq 30\%$  and that of the second bed  $\geq 90\%$ .

This document refers to the American Institute of Architects Guidelines (see above) for recommendations on temperature and humidity.

Laminar airflow is designed to move ultra clean air over the aseptic operating field at a uniform velocity of 0.3 to 0.5 m/s (60 to 100 ft/min).

In a multicenter study involving 8,000 total hip and knee replacements, Lidwell et al. compared the effects of ultra clean air alone and found that the SSI rate decreased from 3.4% to 1.6%.

Intraoperative UV radiation has not been shown to decrease overall SSI risk.

There are no standardized parameters by which to compare microbial levels obtained from cultures of ambient air or environmental surfaces in the operating room, routine microbiologic sampling cannot be justified. Such environmental sampling should only be performed as part of an epidemiologic investigation.

#### SELECTED RECOMMENDATIONS

- 1) Maintain positive-pressure ventilation in the operating room with respect to corridors and adjacent areas. Category IB
- 2) Maintain at least 15 air changes per hour, of which at least 3 (20%) should be fresh air. Category IB
- 3) Filter all air, recirculated and fresh, through the appropriate filter beds per the American Institute of Architects recommendations. (see above) Category IB
- 4) Introduce all air at ceiling, and exhaust near the floor. Category IB
- 5) Do not use UV radiation in the operating room to prevent SSI. Category IB
- 6) Keep operating room doors closed except as needed for passage of equipment, personnel and the patient. Category IB
- 7) Consider performing orthopedic implant operations in operating rooms supplied with ultra clean air. Category II
- 8) Limit the number of personnel entering the operating room to necessary personnel. Category II
- 9) No recommendation on disinfecting environmental surfaces or equipment used in the operating room between operations or in the absence of visible soiling. Unresolved issue
- 10) Do not perform routine environmental sampling of the operating room. Perform microbiologic sampling of operating room environmental surfaces or air only as part of an epidemiological investigation. Category IB

**RANKINGS:**

Category IA – Strongly recommended for implementation and supported by well-designed experimental, clinical or epidemiological studies.

Category IB – Strongly recommended for implementation and supported by some experimental, clinical or epidemiological studies and strong theoretical rationale.

Category II – Suggested for implementation and supported by suggestive clinical or epidemiological studies and strong theoretical rationale.

No recommendation; unresolved issue – Practices for which insufficient evidence or no consensus regarding efficacy exists.

**AVAILABILITY**

Copies of this document can be downloaded free of charge from the Centers for Disease Control website [www.cdc.gov](http://www.cdc.gov)

#### 4) AMERICAN COLLEGE OF SURGEONS COMMITTEE ON OPERATING ROOM ENVIRONMENT

In a letter to the CDC dated August 1998, regarding the above guideline they have expressed general agreement.

They also have the above guideline and a summary available on their website. [www.facs.org](http://www.facs.org)

#### 5) GUIDELINES FOR ENVIRONMENTAL INFECTION CONTROL IN HEALTH-CARE FACILITIES, 2003 – CENTERS FOR DISEASE CONTROL AND PREVENTION

HEALTHCARE INFECTION CONTROL  
PRACTICES ADVISORY COMMITTEE (HICPAC)

**COMMENTS**

This document contains a great deal of very current and useful information and recommendations. It has extensive information on a variety of topics including protective environments, isolation areas, operating rooms, construction and renovation, HVAC systems, water systems, cooling towers, evaporative condensers, water treatment, etc.. It is an excellent source of various engineering recommendations and references for construction and renovation of healthcare facilities.

**HIGHLIGHTS**

Approximately 10% of healthy carriers will disseminate *Staphylococcus aureus* into the air (the most common pathogen associated with surgical site infection). Outbreaks of surgical site infections have been traced to airborne transmission from colonized operating room personnel to patients.

Microbiologic air sampling in operating and protective environment rooms remains controversial as there are no standards for comparison purposes. If performed it should be limited to determining the density of fungal spores per unit volume of air space. High numbers of spores may indicate contamination of air handling system components prior to installation, or a system deficiency when results are compared to known filter efficiencies and rates of air exchange.

No recommendations are given for bacterial or viral microorganism particulate evaluation. (Bacterial microorganisms represent the most common sources of surgical site infections.) No type of sampler and assay procedure exists which can be used to collect and enumerate 100% of airborne organisms.

Measurements can be adversely affected by many factors including filtration efficiency, air volume, outdoor air quality and volume, number of people in the room, the movement of the people, incubation periods of the specific particles, sampling intervals, sample locations, type and accuracy of samplers, various strains of particles, temperature, humidity, time of day or year, etc.. The microbial level in operating room air is directly proportional to the number of people moving about in the room. Operating rooms should be maintained at positive pressure with respect to corridors and adjacent areas. Air should be introduced at the ceiling and exhausted near the floor.

**SELECTED RECOMMENDATIONS**

Air-Handling Systems in Healthcare Facilities

- 1) Use AIA guidelines as minimum standards where state or local regulations are not in place for design and construction of ventilation systems in new or renovated health-care facilities. Ensure that existing structures continue to meet the specifications in effect at the time of construction. Category IC
- 2) Ensure that heating, ventilation, air conditioning (HVAC) filters are properly installed and maintained to prevent air leakages and dust overloads. Category IB
- 3) Monitor areas with special ventilation requirements (e.g., All or PE), for ACH, filtration, and pressure differentials. Category IB, IC
  - a. Develop and implement a maintenance schedule for ACH, pressure differentials, and filtration efficiencies using facility-specific data as part of the multidisciplinary risk assessment. Take into account the age and reliability of the system.
  - b. Document these parameters, especially the pressure differentials.
- 4) Engineer humidity controls into the HVAC system and monitor the controls to ensure proper moisture removal. Category IC
  - a. Locate duct humidifiers upstream from the final filters.



- b. Incorporate a water-removal mechanism into the system.
- c. Locate all duct takeoffs sufficiently down-stream from the humidifier so that moisture is completely absorbed.
- 5) Incorporate steam humidifiers, if possible, to reduce potential for microbial proliferation within the system, and avoid use of cool mist humidifiers. Category II
- 6) Prevent dust accumulation by cleaning air-duct grilles in accordance with facility-specific procedures and schedules when rooms are not occupied by patients. Category IC, II
- 7) Periodically measure output to monitor system function; clean ventilation ducts as part of routine HVAC maintenance to ensure optimum performance. Category II
- 8) Develop a contingency plan for backup capacity in the event of a general power failure. Category IC
  - a. Emphasize restoration of proper air quality and ventilation conditions in All rooms, PE rooms, operating rooms, emergency departments, and intensive care units. Category IC
  - b. Deploy infection-control procedures to protect occupants until power and systems functions are restored. Category IC
- 9) Do not shut down HVAC systems in patient-care areas except for maintenance, repair, testing of emergency backup capacity, or new construction. Category IB, IC
  - a. Coordinate HVAC system maintenance with infection-control staff to allow for relocation of immunocompromised patients if necessary. Category IC
  - b. Provide backup emergency power and air-handling and pressurization systems to maintain filtration, constant ACH, and pressure differentials in PE rooms, All rooms, operating rooms, and other critical-care areas. Category IC
  - c. For areas not served by installed emergency ventilation and backup systems, use portable units and monitor ventilation parameters and patients in those areas. Category II
  - d. Coordinate system startups with infection-control staff to protect patients in PE rooms from bursts of fungal spores. Category IC
  - e. Allow sufficient time for ACH to clean the air once the system is operational. (Appendix B, Table B.1). Category IC
- 10) Whenever feasible, design and install fixed backup ventilation systems for new or renovated construction for PE rooms, All rooms, operating rooms, and other critical care areas identified by ICRA. Category IC

## Infection-Control and Ventilation Requirements for Operating Rooms

- 11) Implement environmental infection-control and ventilation measures for operating rooms.
  - a. Maintain positive-pressure ventilation with respect to corridors and adjacent areas. Category IB, IC
  - b. Maintain  $\geq 15$  ACH, of which  $\geq 3$  ACH should be fresh air. Category IC
  - c. Filter all recirculated and fresh air through the appropriate filters, providing 90% efficiency (dust-spot testing) at a minimum. Category IC
  - d. In rooms not engineered for horizontal laminar airflow, introduce air at the ceiling and exhaust air near the floor. Category IC
  - e. Do not use UV lights to prevent surgical-site infections. Category IB
  - f. Keep operating room doors closed except for the passage of equipment, personnel, and patients, and limit entry to essential personnel. Category IB
- 12) No recommendation is offered for performing orthopedic implant operations in rooms supplied with laminar airflow. Unresolved issue.
- 13) Maintain backup ventilation equipment (e.g., portable units for fans or filters) for emergency provision of ventilation requirements for operating rooms, and take immediate steps to restore the fixed ventilation system function. Category IB, IC

**Note:** They define laminar flow as HEPA filtered air that is blown into the room at a rate of 90 +/- 10 ft./min. in an unidirectional pattern with 100 – 400 ACH.

### RANKINGS:

Category IA – Strongly recommended for implementation and strongly supported by well-designed experimental, clinical or epidemiological studies.

Category IB – Strongly recommended for implementation and supported by certain experimental, clinical or epidemiological studies and a strong theoretical rationale.

Category IC – Required by state or federal regulation, or representing an established association standard.

Category II – Suggested for implementation and supported by suggestive clinical or epidemiological studies or a theoretical rationale.

Unresolved issue – No recommendation is offered. No consensus or insufficient evidence exists regarding efficacy.

### AVAILABILITY

Copies of this document can be downloaded free of charge from the Centers for Disease Control website at the following address.

[www.cdc.gov/ncidod/hip/enviro/guide.htm](http://www.cdc.gov/ncidod/hip/enviro/guide.htm)

## 6) DEPARTMENT OF VETERANS AFFAIRS

DESIGN INSTRUCTIONS TO ARCHITECTS AND ENGINEERS  
 HVAC DESIGN MANUAL FOR HOSPITAL/REPLACEMENT  
 HOSPITAL/AMBULATORY CARE/CLINICAL ADDITION/ENERGY CENTER/SATELLITE OUTPATIENT CLINIC PROJECTS  
 (FEBRUARY 1, 2000)

### COMMENTS

Very informative source for detailed requirements in hospital HVAC systems. Specifically intended for VA hospitals but very useful for other projects.

### HIGHLIGHTS

Operating room design conditions –  
 Summer 19°C (68°F) Db – 55% RH  
 Winter 23°C (75°F) Db – 50% RH  
 All thermostats adjustable from 15°C (60°F) to 29°C (85°F).  
 Operating Rooms 15 ACH (occupied) – 8 ACH (unoccupied).  
 100 % outdoor air supply to operating rooms.  
 Operating rooms – design noise criteria NC 40.  
 Constant volume terminal reheat system (2 position) for operating rooms.  
 Filter efficiencies  
 – operating rooms – 30% pre-filters, 95% after-filters  
 – orthopedic surgery – 30% pre-filters, HEPA (99.97%) after-filters  
 Duct lining –  
 Air terminal units in supply air duct for operating rooms shall be unlined.  
**Note:** Air terminal units with factory applied fiberglass liner, coated to prevent erosion and no exposed edges, is permitted in terminal units located downstream of after-filters in other areas.  
 Each operating room shall have individual temperature and humidity control.  
 Exhaust duct shall be equipped with corresponding 2 position tracking airflow to maintain pressure relationship during occupied and unoccupied times.

Air Distribution in Surgery Suite – supply air duct on the downstream side of the after-filters shall be stainless steel with air tight access panels at each elbow and at 6 m (20 ft) intervals on straight runs. The air distribution for each OR shall have stainless steel multiple slot panel diffusers positioned around operating tables to discharge 70% supply air in a vertical air stream inclined at a 15° outward angle. The remaining 30% supply air shall be delivered downward over the operating area using perforated face outlets. Provide a minimum of two exhaust registers in each OR located diagonally opposite each other seven inches above the finished floor. The exhaust air quantity shall be at least 15% less than the supply air to maintain positive pressure between the OR and the adjoining areas.

Individual terminal humidifier for each OR on the downstream side of the dedicated constant volume reheat air terminal unit.

Each OR shall be furnished with temperature and humidity recorders to keep a continuous record.

Surgical Light Fixture – Note the location of the mounting plate is not to be placed directly over the operating table. That zone must be kept unobstructed for the supply air outlet and the plenum serving it above the ceiling.

### AVAILABILITY

Copies of this document can be downloaded free of charge from the department of Veterans Affairs website at [www.va.gov/facmgt/standard/](http://www.va.gov/facmgt/standard/)



## 7) FEDERAL STANDARD 209E – SEPTEMBER 11, 1992

AIRBORNE PARTICULATE CLEANLINESS  
CLASSES IN CLEANROOMS AND CLEAN ZONES

### COMMENTS

Very detailed standard on testing cleanrooms and procedures and equipment used. Has little or nothing relevant to operating room design, classification, or evaluation of the effectiveness of the air system in controlling airborne microbiological contaminants. Commonly cited by manufacturers in their testing and evaluation of operating room systems.

### HIGHLIGHTS

This document establishes standard and alternate classes of air cleanliness for cleanrooms and clean zones based on specified concentrations of airborne particles.

This document is not intended to characterize the physical, chemical, radiological, or viable nature of airborne particles. No universal relationship has been established between the concentration of airborne particles and the concentration of viable airborne particles.

The following table defines the various airborne particulate cleanliness classes. The limits shown are the number of particles per unit volume equal to or larger than the sizes shown.

### AVAILABILITY

The U.S. General Services Administration (GSA) has released, on November 29, 2001, a notice of cancellation for this standard. It is now superseded by ISO 14644-1 Part 1: Classification of Air Cleanliness; and ISO 14644-2 Part 2: Specifications For Testing and Monitoring to Prove Continued Compliance with ISO 14664-1.

Class Name**		Class Limits									
		0.1 μm		0.2 μm		0.3 μm		0.5 μm		5 μm	
		Volume Units		Volume Units		Volume Units		Volume Units		Volume Units	
SI	English***	(m <sup>3</sup> )	(ft. <sup>3</sup> )	(m <sup>3</sup> )	(ft. <sup>3</sup> )	(m <sup>3</sup> )	(ft. <sup>3</sup> )	(m <sup>3</sup> )	(ft. <sup>3</sup> )	(m <sup>3</sup> )	(ft. <sup>3</sup> )
M 1		350	9.91	75.7	2.14	30.9	0.875	10.0	0.283	–	–
M 1.5	1	1240	35.0	265	7.50	106	3.00	35.3	1.00	–	–
M 2		3500	99.1	757	21.4	309	8.75	100	2.83	–	–
M 2.5	10	12400	350	2650	75.0	1060	30.0	353	10.0	–	–
M 3		35000	991	7570	214	3090	87.5	1000	28.3	–	–
M 3.5	100	–	–	26500	750	10600	300	3530	100	–	–
M 4		–	–	75700	2140	30900	875	10000	283	–	–
M 4.5	1000	–	–	–	–	–	–	35300	1000	247	7.00
M 5		–	–	–	–	–	–	100000	2830	618	17.5
M 5.5	10000	–	–	–	–	–	–	353000	10000	2470	70.0
M 6		–	–	–	–	–	–	1000000	28300	6180	175
M 6.5	100000	–	–	–	–	–	–	3530000	100000	24700	700
M 7		–	–	–	–	–	–	10000000	283000	61800	1750

**TABLE 5: FEDERAL STANDARD 209E**

Airborne particulate cleanliness classes – class limits are given for each class name. The limits designate specific concentrations (particles per unit volume) of airborne particles with sizes equal to and larger than the particle size shown.

## 8) INTERNATIONAL STANDARD – ISO 14644-1

FIRST EDITION 1999-05-01  
CLEANROOMS AND ASSOCIATED  
CONTROLLED ENVIRONMENTS –  
PART 1: CLASSIFICATION OF AIR CLEANLINESS

### COMMENTS

This standard is similar to the now cancelled FED-STD-209E which it replaces. This part of ISO 14644 covers the classification of air cleanliness in cleanrooms and associated controlled environments exclusively in terms of concentration of airborne particles.

### HIGHLIGHTS

The standard provides various definitions related to cleanrooms such as airborne particles, U and M descriptors, occupancy states and classifications. It defines the proper designation of airborne particulate cleanliness as well as a reference test method for compliance, test report criteria and statistical treatment of particle concentration data.

### AVAILABILITY

Copies of this standard, as well as other standards and publications relating to cleanrooms can be purchased from the Institute of Environmental Sciences and Technology (IEST). Visit their website and online publication store at [www.iest.org](http://www.iest.org)

## 9) DEFINITION OF SURGICAL MICROBIOLOGIC CLEAN AIR COMMITTEE ON OPERATING ROOM ENVIRONMENT, AMERICAN COLLEGE OF SURGEONS

REPRINTED FROM THE AMERICAN COLLEGE  
OF SURGEONS BULLETIN – JANUARY 1976

### COMMENTS

Some manufacturers refer to this document when evaluating the effectiveness of their air distribution system. This document is no longer available from the American College of Surgeons. It was a tentative definition of air cleanliness classes, however it is not referenced in any of the above standards or guidelines and has not been adopted by any authorities as a valid classification. It was intended to be an initial working document with the suggestion that specialty societies and the National Research Council develop the concept of a definition further. It does not define proper testing methods, criteria, equipment or conditions.

The current medical literature disputes the types and quantities of microbiologic particles necessary for an infection to occur and until further research is done they do not advocate the microbiologic testing of air except as part of an investigation to determine the specific sources of various infections. One such investigation has found infection outbreaks in protective environment areas where fungal spore concentrations ranged as low as 0.025 – 0.062 colony forming units per cubic foot of air (40 times lower than Class 1). Current guidelines from the CDC state that there are no standards available for comparison purposes, however, if microbiologic sampling is performed it should be limited to determining the density of fungal spores per unit volume of air space. High numbers of spores may indicate contamination of air handling system components prior to installation, or a system deficiency when culture results are compared to known filter efficiencies and rates of air exchange. No recommendations are given for bacterial or viral microorganism particulate evaluation. Bacterial microorganisms are the most common sources of surgical site infections.

Measurements can be adversely affected by many factors including filtration efficiency, air volume, outdoor air quality and volume, number of people in the room, the movement of the people, incubation periods of the specific particles, sampling intervals, sample locations, type and accuracy of samplers, various strains of particles, temperature, humidity, time of day or year etc...

ISO Class	Concentration Limits, Particles per Cubic Metre					
	0.1 µm	0.2 µm	0.3 µm	0.5 µm	1 µm	5 µm
1	10	2				
2	100	24	10	4		
3	1,000	237	102	35	8	
4	10,000	2,370	1,020	352	83	
5	100,000	23,700	10,200	3,520	832	29
6	1,000,000	237,000	102,000	35,200	8,320	293
7				352,000	83,200	2,930
8				3,520,000	832,000	29,300
9				35,200,000	8,320,000	293,000

**TABLE 6: ISO 14644-1 CLASSIFICATION OF AIR CLEANLINESS**

Selected airborne particulate cleanliness classes for cleanrooms and clean zones. This table shows maximum concentration limits for particles equal to and larger than the considered sizes shown.

## HIGHLIGHTS

This definition is presented by the Committee on Operating Room Environment as a concept of a tentative statement of the definition of microbiologic air cleanliness in response to a resolution adopted in November 1974 at a workshop jointly sponsored by the Academy of Orthopaedic Surgeons and the Assembly of Life Sciences of the National Research Council held in Washington, D.C.

States that Federal Standard 209B (now superceded by ISO 14644) does not provide adequate definitions and that there is no consistent ratio between viable (microbially inhabited) airborne particulates and nonviable ones.

The objective of this definition is to establish a classification of environmental air cleanliness so that its effects can be evaluated and controlled.

## DEFINES THREE CLASSES:

**CLASS 1 MICROBIOLOGIC CLEANLINESS:** Viable microbiologic airborne particle counts not to exceed one particle per cubic foot of air with minimum sample of 30 cubic feet of air.

**CLASS 5 MICROBIOLOGIC CLEANLINESS:** Viable microbiologic airborne particles to average more than one and up to five per cubic foot of air with minimum sample of 30 cubic feet of air.

**CLASS 20 MICROBIOLOGIC CLEANLINESS:** Viable microbiologic airborne particles to average more than five and not to exceed twenty per cubic foot of air with minimum sample of 10 cubic feet of air.

## AVAILABILITY

This document is no longer available from the American College of Surgeons.

## 10) MILITARY HANDBOOK MIL-HDBK-1191

DEPARTMENT OF DEFENSE - UNITED STATES OF AMERICA

MEDICAL AND DENTAL TREATMENT FACILITIES DESIGN AND CONSTRUCTION CRITERIA

CHAPTER 8 – HEATING VENTILATION AND AIR CONDITIONING

## COMMENTS

General guidelines for design and construction. References ASHRAE and other sources for specific information.

## HIGHLIGHTS

All air supplied to cardiac catheterization rooms (hospital based), delivery rooms, nurseries, operating rooms, specialized patient bedrooms and surgical cleanrooms shall be as specified in Appendix A. Air movement shall range from a preferred 25 fpm (0.127 m/s) to a maximum of 100 fpm (0.508 m/s) over the sterile field.

There should be a minimum of two exhaust registers in each room with bottoms not less than 6 inches (150 mm) nor more than 9 inches (230 mm) above the finished floor and diagonally opposite each other.

Appendix A gives very detailed room specific design requirements, for all room types, for architects and engineers. Ex: Operating rooms for cardiothoracic surgery, neurosurgery, orthopedic surgery have the following design conditions: positive pressure with room exhaust 20% less than supply, minimum 15 ACH total with minimum of 5 ACH outside air, 68 – 76°F (20 – 24°C), 50 – 60% relative humidity, room sound level NC 30 – 35 and 99.97% HEPA filters. Operating rooms for cystoscopic surgery, general surgery, outpatient surgery and labor/delivery rooms have the same requirements but with 90% final filters.

Air supply shall be 15 ACH unless a higher rate is required to meet cooling requirement and may be totally exhausted when the room is in use. The option as to whether to utilize recirculated air during an operation is left to the discretion of the individual military departments. Should recirculated air be utilized, the minimum outside air requirements would apply. During periods of non-use, either (1) 75% of the air may be recirculated or (2) air volume may be reduced to 3 ACH while maintaining the required air balance. All systems shall, if cost effective, use exhaust air energy recovery to precondition the incoming outside air.

Provide adjustable (to user) thermostat and humidistat within the room.

For isolation rooms used for patients with a high susceptibility to infection from leukemia, burns, bone marrow transplant, organ transplant or AIDS, HEPA filters should be used on air supply system.

## AVAILABILITY

Copies of this document can be downloaded free of charge from the Department of Defense website at <http://stinet.dtic.mil>

## 11) CSA STANDARD Z317.2.01 – SPECIAL REQUIREMENTS FOR HEATING, VENTILATION, AND AIR CONDITIONING (HVAC) SYSTEMS IN HEALTH CARE FACILITIES

### COMMENTS

Very detailed standard for the design and construction of healthcare facilities in Canada. It forms part of the Canadian building code requirements.

### HIGHLIGHTS

All rooms and areas within a health care facility shall be ventilated to ensure an air exchange adequate to control contaminant levels, temperature and humidity. The ventilation system shall be designed to provide air movement that is generally from clean to less clean areas. Air quality guidelines shall be developed for all occupants, functions, procedures and areas in the health care facility at the conceptual design stage. HVAC systems shall be designed, installed, operated and maintained to minimize the potential for infection via airborne transmission. Smoke management shall be part of the HVAC system design and shall be approved by the authority having jurisdiction in the early stages of design.

### SELECTED RECOMMENDATIONS

Air handling systems for Class I areas (operating rooms, recovery rooms, intensive and cardiac care, delivery rooms etc...) may operate at a minimum level when the space is unoccupied. A minimum level shall consist of at least 6 ACH of recirculated air and the maintenance of pressure relationships with adjacent areas.

Where present, HEPA filters in the supply air system shall be; located at the point where the air enters the room; provided with test ports before and after the filters and tested for integrity using a scan test upon installation; designed to permit removal, disposal and replacement of filters without introducing contamination into the downstream air delivery system or the area being served; and provided with a means to indicate operating pressure drop via the building management system or a local alarm. Access doors shall be located at not more than 6 m (20 ft.) intervals on supply air ductwork installed after a HEPA filter. Diffuser, grille and register cores in air systems shall be removable for cleaning.

Class I air handling systems shall be cleaned and disinfected prior to occupancy.

The pressure differential between areas shall be greater than 0.762 mm (0.03") of water pressure.

Air supply for operating rooms, delivery rooms and other rooms used for invasive procedures shall be through non-aspirating ceiling outlets near the centre of the work area. Each operating and delivery room shall have at least two return or exhaust air inlets located remotely from each other. The position of the inlets shall be such

that areas without air movement (i.e. dead zones) are minimized. The bottom ventilation (return/exhaust) openings shall be at least 75 mm (3") above the floor. Low-level grille cores shall be removable with 1/4 turn fasteners for cleaning, leaving the mounting frame in place. (Note: Operating room supply, exhaust/return grilles and air boots shall be manufactured from material that can be disinfected (eg. stainless steel)).

Operating rooms, delivery rooms, intensive care units and other such places where it is impractical to move a patient in an emergency shall be provided with a mechanical air supply that will continue to operate in a fire to assist in keeping the areas smoke free.

Table 1 provides specific HVAC criteria for all areas of the facility: (Example: Operating rooms – minimum outdoor air 6 ACH, minimum total air 20 ACH, positive pressure, temperature 17 – 27°C (63 – 81°F), relative humidity 45 – 55%).

Table 4 provides filter efficiencies for various room types (Example: Specialized operating rooms, isolation rooms – 99.97% DOP and patient care areas 90% (ANSI/ASHRAE Standard 52.1)).

Table 7 provides noise levels for the various room types (Example: Operating rooms, private rooms, intensive care unit, coronary care unit 25 – 35 RC (neutral)).

### AVAILABILITY

Copies of this document can be purchased from the Canadian Standards Association online at [www.csa.ca](http://www.csa.ca)

**12) CONSTRUCTION-RELATED  
NOSOCOMIAL INFECTIONS IN  
PATIENTS IN HEALTH CARE FACILITIES:  
DECREASING THE RISK OF  
ASPERGILLUS, LEGIONELLA AND  
OTHER INFECTIONS**

CCDR VOLUME: 27S2

JULY, 2001

DIVISION OF NOSOCOMIAL AND  
OCCUPATIONAL INFECTIONS  
BUREAU OF INFECTIOUS DISEASES,  
CENTRE FOR DISEASE PREVENTION & CONTROL  
POPULATION AND PUBLIC HEALTH BRANCH  
HEALTH CANADA

**COMMENTS**

This document contains some very useful suggestions for decreasing the risk to patients and healthcare workers during construction and renovation. It summarizes some documented cases of infections and deaths associated with construction activity. It provides a risk assessment and preventative measures checklist. It also provides a detailed specification on the infection prevention and control measures that should be undertaken. It recommends various procedures, preventative measures and construction techniques that should be considered before, during and after construction.

**AVAILABILITY**

Copies of this document can be downloaded free of charge from Health Canada's website  
[www.hc-sc.gc.ca/pphb-dgspsp/dpg\\_e.html](http://www.hc-sc.gc.ca/pphb-dgspsp/dpg_e.html)