INSTALLATION & OPERATION MANUAL

**FAN POWERED CHILLED WATER (DOAS)
TERMINAL UNIT**

MODEL SERIES: 33SZ



CONTENTS

- General** 3
 - Receiving Inspection Checklist 3
 - Safety Precautions..... 3
- Installation**..... 3
 - Supporting the Assembly 3
 - Duct Connections..... 4
 - Minimum Access..... 4
 - Field Wiring 4
 - Electrical Suggestions and Requirements 4
 - Water Pipe Connections 4
- Control Start-up and Operation**..... 4
 - Primary Air Damper and Fan Adjustment 4
 - Starting the fan motor: 4
- Maintenance Procedures** 4-5
 - Fan and Motor..... 5
 - If fan motor does not run, do the following: 5
 - Fan motor runs but emits excessive noise 5
 - Fan motor runs, but airflow too low: 5
 - If repair or replacement is required..... 5
 - Primary Air Damper Replacement 5
 - Labels 5-6
- Replacement Parts** 7-8
- Appendix A – MCA and MOP Calculations** 9
- Orientations** 9

General

Receiving Inspection Checklist

- Visually inspect unit for shipping damage before unwrapping any packaging material. Report any damage immediately to the delivering carrier.
- After unpacking the unit, check it again for shipping damage. If any shipping damage is found, report it immediately to the delivering carrier.
- Notify your local Nailor representative of damage and arrange for repair or replacement.
- Check that the unit is labeled as intended and deliver to appropriate site location.
- Store units in a clean, dry location.



Caution: Do not use the inlet collar, damper shaft, airflow sensor, electrical conduit, water coil extremities, drip pan, or tubing as a handle to lift or move assembly. Damage to the unit, unit accessories or controls may result.

Safety Precautions

- All person(s) involved in installation process shall be qualified according to all relevant local codes and standards.
 - Equipment is not to be used by persons (including children) with reduced physical, sensory, or mental capabilities, or lack of experience and knowledge, unless they have been given supervision or instruction.
 - Beware of other building utilities and electrical wiring during installation process.
 - The unit installed shall be used only as intended. Any unintended use shall therein result in immediate forfeiture of manufacturer assumed warranty, responsibility and liability of product and associated components. Contact your local Nailor representative for questions.
- 

Warning: Make sure all electrical power to the unit has been disconnected and any capacitors fully discharged before servicing. Failure to do so could result in injury or death.
 - During brazing process, make sure to protect any surrounding flammable materials, using barriers where applicable and always have a fire extinguisher accessible.
 - 

Caution: DO NOT exceed coil's parameters. The coil's water temperature range is 40°F - 200°F. For standard coil wall thickness 0.016", the coil's maximum working pressure is 250 PSIG.
 - 

Caution: Any improper product handling, installation, servicing, or operation resulting in personal injury and property damage shall void any manufacturer assumed legal responsibility.
- Equipment's maximum altitude of use is 2,200 m.

Installation

Supporting the Assembly

Suspend the unit from the building structure in the horizontal plane and ensure the unit is level to guarantee proper performance. Be careful not to obstruct all the access panels with support channels or straps. When requested, unit is supplied with field mounted hanger brackets for use with hanger rod up to 3/8" (9.5) dia. Hanger brackets or straps should be screwed to the top corner posts, unit casing sides or alternatively onto the inlet and outlet ends of the unit if the top corner posts are not accessible. Note that low profile unit do not contain corner posts.



Caution: Nailor 33SZ units are too heavy to suspend with the ductwork and must be independently supported.

Nailor recommends attaching straps or screws into the 18 gauge frame (corner posts) of the size 40, 50 and 55 units when possible and into the inlet, outlet or side panels of the size 10, 30 and 35 units.

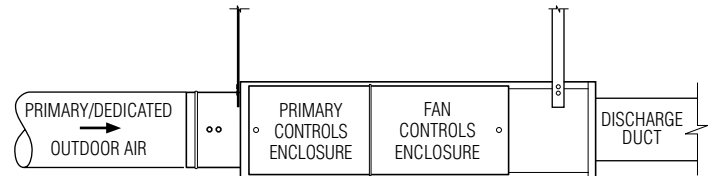

Figure 1: Fan Powered Chilled Water Terminal Unit Support Using Hanger Straps (Model 33SZ unit size 30 illustrated).

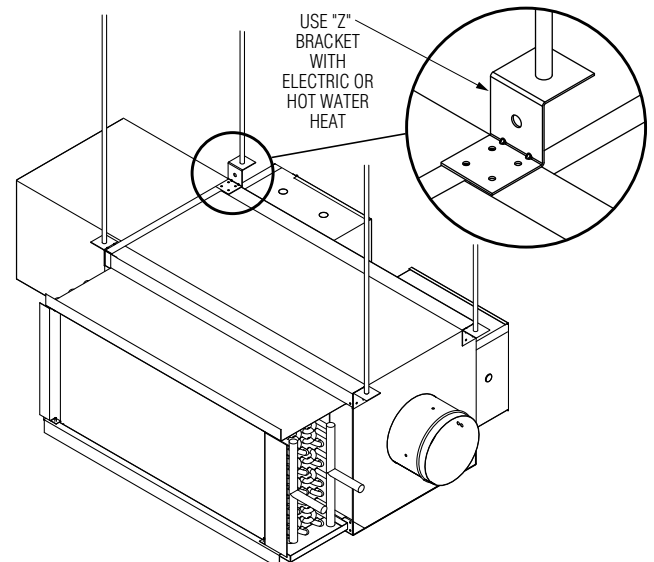
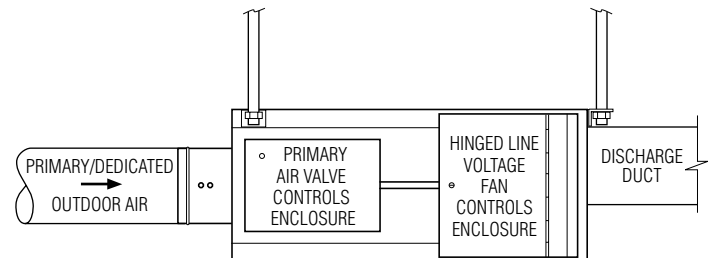

Figure 2: Fan Powered Chilled Water Terminal Unit Support Using Hanger Brackets and Rods (Model 33SZ unit size 40/50/55 illustrated).

Duct Connections

All ducts should be installed in accordance with SMACNA guidelines. Zero clearance to combustible materials is allowed. Slip each inlet duct over the inlet collar of the terminal. Fasten and seal the connection by the method prescribed in the job specification. The diameter of the inlet duct in inches must be equal to the nominal size of the terminal inlet. The inlet collar of the terminal is 1/8" (3) smaller than the nominal duct size to allow it to fit inside the duct. Important: Do not insert ductwork inside the inlet collar of the assembly. For optimum performance, 2 to 3 equivalent diameters of straight duct should be installed prior to the inlet of the unit. Rectangular discharge opening is designed for a flanged duct connection. A clear area around the opening has been left for screw penetration. Fasten and seal all connections by method prescribed in the job specification. The range of external static pressures for model series 33SZ was tested at: 0 - 0.5" WC.

Minimum Access

Make appropriate accommodations for access panel removal. If unit is to be installed in **hard ceiling/wall application**, refer to Nailor 33SZ submittals for specific dimensions before installing to assure there is access to the unit and components after installation is complete. Nailor 33SZ units have access panels on the top and bottom. For low voltage control enclosure access, a minimum of 18" (457) is recommended. Specific control enclosure location is indicated on product submittals. Low voltage control enclosures have removable covers that are attached with sheet metal screws. High voltage controls enclosures have access panels that are equipped with hinges. For clearances for full opening of hinged access doors, refer to project specifications, submittal sheets and NEC.



Caution: These recommendations do not preclude NEC or local codes that may be in effect, which are the responsibility of the installing contractor.

Field Wiring

All field wiring must comply with NEC and local codes. Disconnect switches are optional. Wiring diagrams can be found on labels affixed to the exterior/interior of the control box enclosure. Unless specifically requested by customer, all units are wired for a single point connection to the fan and electric heater (if present). All electric heaters will be staged per specification. Motors rated for 277 or 120 VAC on units with 480 or 208 VAC ratings respectively are always connected between the neutral and L1 terminals. The installing electrician should rotate the incoming electric service by phase to help balance the building electric load.

Fuse size designates the size of the internal fuse if it is supplied. Maximum Overcurrent Protection (MOP) designates the largest breaker or fuse in the electrical service panel that can be used to protect the unit. See appendix A for calculation details.

Electrical Suggestions and Requirements

1. Provide a safety disconnect per NEC 424-19, 20, 21.
2. Disconnect the power supply before wiring or servicing unit. If a disconnect switch is present, it should be in the OFF position while making power connections or repairs.
3. All units with electric heat should have copper wires sized for minimum circuit ampacity (MCA). See appendix A for calculation details.
4. Follow wiring diagrams and instructions mounted on the unit. 480V/3 phase heaters, for example, require a neutral wire in addition to the full sized ground wire. NEC 424-15 and 250 also require that all units be grounded.

Water Pipe Connections

Exercise extreme caution during "sweating" or brazing process of coil piping to avoid applying excessive heat to components associated

with valve package. This could cause irreversible damage, requiring immediate replacement of parts. Make sure valves are in full open position during brazing process. Heat can be dissipated more effectively by wrapping a wet towel around the valve body during the brazing process.

Make sure final piping configuration does not interfere with sensible cooling coil and integral drip pan. Remove any residual air pockets from inside the coil through available air vents. Once the coil has been pressure tested, insulate piping and components as required to prevent potential condensation issues.

Control Start-up and Operation

Your local Nailor Representative can provide detailed information about start-up and operating procedures for Nailor's digital, analog, and pneumatic controls. For specific information on controls provided by other manufacturers contact the control manufacturer's local or national office. This applies whether the controls were factory or field installed.



Note: Digital controllers may use specific communication addresses based on Building Management Systems, Architecture and original engineering drawings. Installing the terminal in a location other than that noted on the label may result in excessive start-up labor.

Primary Air Damper and Fan Adjustment

Before starting the fan motor:

- a. If filters are required, make sure they are installed as intended.
- b. Make sure duct system is clear of all debris and foreign objects.
- c. Ensure unit enclosure, blower housing and blower wheel are free of any debris and foreign objects.

Starting the fan motor:

1. Start motor and let it run-in at least 15 minutes. During run-in, check ductwork connections for leaks and repair if necessary.
2. All 33SZ units are equipped with ECM motors. Set the primary air dampers as described in (3). Set the fan as described on page one of the IOM for EPIC Fan Volume Controller with (Genteq EON) ECM Motor, found in the IOM section at www.nailor.com. Proportion the dampers after the fan is set. Remember to adjust the dampers so that they are in the most open condition after proportioning. This will generate the minimum noise.
3. Set the unit to full cooling. Adjust and set primary maximum cfm by measuring the airflow with a manometer attached between the gauge ports in the pneumatic tube leading to the high and low sides of the inlet air pick-up. A chart is attached to the side of the unit showing airflow vs. pressure for different inlet sizes. Adjust and set remote balancing dampers, if present. Do not worry about airflow at this time; just proportion the outlets with the dampers. Be sure to leave the dampers in the most possible open position. This will generate the minimum noise level. Adjust the fan speed control until the required CFM is obtained (by measuring the air quantity at the room outlets). Fan should be adjusted with primary air at maximum set point to ensure that no supply air is discharged at the induction port. Recheck the fan and primary airflows when the damper is reset to the minimum set point.

Maintenance Procedures

Warning: Electrical Hazard!

Before Servicing, disconnect all sources of electrical power, including the complete discharge of any electric current stored in capacitors included in the wiring structure. Practice good lockout/tagout procedures to prevent energizing of the unit during servicing. Failure to comply with previous statements could yield personal injury or even result in death.

Fan and Motor

Nailor 33SZ units are equipped with permanently lubricated motors. Inspect fan and motor assembly for dust and dirt as often as dictated by operating environment. Clean assembly if necessary.

If fan motor does not run, do the following:

- Check for free rotation of blower wheel. Make sure no foreign objects are in fan. Look for signs of freight or job site damage.
- Check power supply. Disconnects should be in the "ON" position. Optional fusing should also be inspected. Check transformer for proper output.
- Check for proper control signals.

Fan motor runs but emits excessive noise

- Maximum airflow may be too high, or discharge static pressure may be incorrect.
- Blower may have clearance problems. Make sure all components are securely attached.
- Verify integrity of ductwork. Leaks or loose connections could cause noise. Check for rattling diffusers or rattling or incorrectly adjusted balancing dampers.

Fan motor runs, but airflow too low:

- May be due to ductwork restrictions, dirty air filters or clogged.
- Readjust fan speed control on control card.
- Discharge static pressure may be incorrect. Check balancing dampers.
- Confirm signal from the motor card to the motor by measuring the plug at the motor.

If repair or replacement is required

Disconnect all power before servicing. Motor and fan should be removed as an assembly. Remove the four hex nuts from mounting lugs holding the fan assembly to the discharge panel, and remove the assembly through any convenient access panel. Do not allow assembly to hang from wiring. If removing motor from blower, first loosen the set screw holding the blower wheel to the motor shaft. Remove the three screws holding the motor to the fan housing, and slide motor and fan housing apart.

To put the assembly back together, reverse the procedure. Be sure to align the blower set screw with the flat section of motor shaft.

Note: Over-tightening motor mounting screws may crush isolation bushing, causing excessive fan noise.

Primary Air Damper Replacement

Nailor's primary air valve assembly is not repairable. The entire assembly should be replaced if it is damaged.

Labels

Each 33SZ unit is shipped with a nameplate label affixed to the control casing. Principle nameplate data on the label typically include Order-Serial number, Model number, Unit size, Motor horsepower, Amperage, MOP, Heater (if present) data, Supply voltage and Airflows. Also provided are calibration, airflow, as well as other labels as necessary. We suggest that you read all labels before beginning installation. If you have any questions, please contact your local Nailor Representative. Their phone numbers can be found on our website at nailor.com.

Label Example

			FAN COIL (UNITE TERMINALE @ TERMINAL UNIT VENTILATEUR INTEGRÉ)																																																																			
DATE (DATE) : 5-Jun-2015 MODEL (MODÈLE) : D33SZE UNIT SIZE - INLET SIZE : 40-06 (DIAMÈTRE D'ENTRÉE) CONTROL VOLTAGE : 24 (VOLTAGE DE CONTRÔLE) CONTROL SEQUENCE : NB (SEQUENCE DE CONTRÔLE) VOLT AMP (VOLT-AMPÈRE) : HOT WATER COIL ROWS : (NOMBRE DE RANGÉES SERPENTIN EAUCAUDE) CHILLED WATER COIL ROW : 2 (NOMBRE DE RANGÉES SERPENTIN EAU RÉFRIGÉRÉE)			SERIAL NO. (NO. DE SÉRIE) : 481059-2.01 TAG NO. (NO. D'ÉTIQUETTE) : VOLTAGE (VOLTAGE) : 480 PHASE (PHASE) : 3 STAGES (ÉTAPES) : 1 HZ. (HZ) : 50/60 WATTS : 560 MOTOR VOLTAGE : 277 (VOLTAGE DU MOTEUR) MOTOR AMP : 4.2 (AMPERAGE DU MOTEUR)																																																																			
<table border="1"> <thead> <tr> <th colspan="3">KW/WATTS</th> <th colspan="3">AMPS (AMPÈRES)</th> <th colspan="3">AMPACITY (AMPACITÉ)</th> <th colspan="2">MAX. OVERCURRENT PROTECTION (RESISTANCE DES FUSIBLE MAX.)</th> <th rowspan="2">INTERNAL FUSE SIZE (IF SUPPLIED)</th> </tr> <tr> <th>TOTAL (TOTALE)</th> <th>EACH CIR. (CHAQUE CIRCUIT)</th> <th>EACH STG. (CHAQUE ÉTAPE)</th> <th>TOTAL (TOTALE)</th> <th>EACH CIR. (CHAQUE CIRCUIT)</th> <th>EACH STG. (CHAQUE ÉTAPE)</th> <th>TOTAL (TOTALE)</th> <th>EACH CIR. (CHAQUE CIRCUIT)</th> <th>EACH STG. (CHAQUE ÉTAPE)</th> <th>TOTAL (TOTALE)</th> <th>EACH CIR. (CHAQUE CIRCUIT)</th> </tr> </thead> <tbody> <tr> <td>HEATER (CHAUFFAGE)</td> <td>3.0</td> <td>3.0</td> <td>3.0</td> <td>3.6</td> <td>3.6</td> <td>3.6</td> <td>4.5</td> <td>4.5</td> <td>4.5</td> <td>15</td> <td>15</td> <td>15</td> </tr> <tr> <td>MOTOR (MOTEUR)</td> <td>560</td> <td></td> <td></td> <td>4.2</td> <td></td> <td></td> <td>5.2</td> <td></td> <td></td> <td></td> <td></td> <td>15.0</td> </tr> <tr> <td>TOTAL (TOTALE)</td> <td></td> <td></td> <td></td> <td>7.8</td> <td></td> <td></td> <td>9.8</td> <td></td> <td></td> <td></td> <td></td> <td></td> </tr> </tbody> </table>			KW/WATTS			AMPS (AMPÈRES)			AMPACITY (AMPACITÉ)			MAX. OVERCURRENT PROTECTION (RESISTANCE DES FUSIBLE MAX.)		INTERNAL FUSE SIZE (IF SUPPLIED)	TOTAL (TOTALE)	EACH CIR. (CHAQUE CIRCUIT)	EACH STG. (CHAQUE ÉTAPE)	TOTAL (TOTALE)	EACH CIR. (CHAQUE CIRCUIT)	EACH STG. (CHAQUE ÉTAPE)	TOTAL (TOTALE)	EACH CIR. (CHAQUE CIRCUIT)	EACH STG. (CHAQUE ÉTAPE)	TOTAL (TOTALE)	EACH CIR. (CHAQUE CIRCUIT)	HEATER (CHAUFFAGE)	3.0	3.0	3.0	3.6	3.6	3.6	4.5	4.5	4.5	15	15	15	MOTOR (MOTEUR)	560			4.2			5.2					15.0	TOTAL (TOTALE)				7.8			9.8						EACH ELEMENT RATED @ <u>1.0</u> KW @ <u>277</u> VAC. (CHAQUE ÉLÉMENT CLASSIFIÉ A)			AWG. MIN WIRE SIZE (MIN DIAMÈTRE DE FIL) : <u>14</u> MIN. HEATING CFM (MIN. PCM) : <u>210</u>		
KW/WATTS			AMPS (AMPÈRES)			AMPACITY (AMPACITÉ)			MAX. OVERCURRENT PROTECTION (RESISTANCE DES FUSIBLE MAX.)		INTERNAL FUSE SIZE (IF SUPPLIED)																																																											
TOTAL (TOTALE)	EACH CIR. (CHAQUE CIRCUIT)	EACH STG. (CHAQUE ÉTAPE)	TOTAL (TOTALE)	EACH CIR. (CHAQUE CIRCUIT)	EACH STG. (CHAQUE ÉTAPE)	TOTAL (TOTALE)	EACH CIR. (CHAQUE CIRCUIT)	EACH STG. (CHAQUE ÉTAPE)	TOTAL (TOTALE)	EACH CIR. (CHAQUE CIRCUIT)																																																												
HEATER (CHAUFFAGE)	3.0	3.0	3.0	3.6	3.6	3.6	4.5	4.5	4.5	15	15	15																																																										
MOTOR (MOTEUR)	560			4.2			5.2					15.0																																																										
TOTAL (TOTALE)				7.8			9.8																																																															
USE WIRE SUITABLE FOR AT LEAST 75°C L1 IS COLOR CODED BLACK, L2 IS BLUE, L3 IS RED CONTROL WIRES CODED AS MARKED USE COPPER CONDUCTORS ONLY.						UTILISER UN FIL MÉTALLIQUE QUI CONVIENT AU MOINS 75 °C L1 EST COLORÉ NOIRE, L2 EST BLEU, L3 EST ROUGE. LES FILS DE CONTRÔLE SONT IDENTIFIÉS COMME MARQUE, UTILISÉ DES CONDUCTEURS DE CUIVRE SEULEMENT.																																																																
USE CLASS K, RK1, A2D OR A6D FUSE OR HACR BREAKERS.						UTILISÉ DES FUSIBLES CLASS K, RK1, A2D, OU A6D OU HACR DISJONCTEURS.																																																																
MAX FAN CLG / MIN DEADBAND (CFM) : _____ MAX FAN CLG / MIN Bande Morte (CFM) : _____ MAX FAN HTG (CFM) : _____			MAX FAN CLG / MIN DEADBAND (L/S) : _____ MAX FAN CLG / MIN Bande Morte (L/S) : _____ MAX FAN HTG (L/S) : _____																																																																			

Sample Diamond Flow Sensor Calibration Label

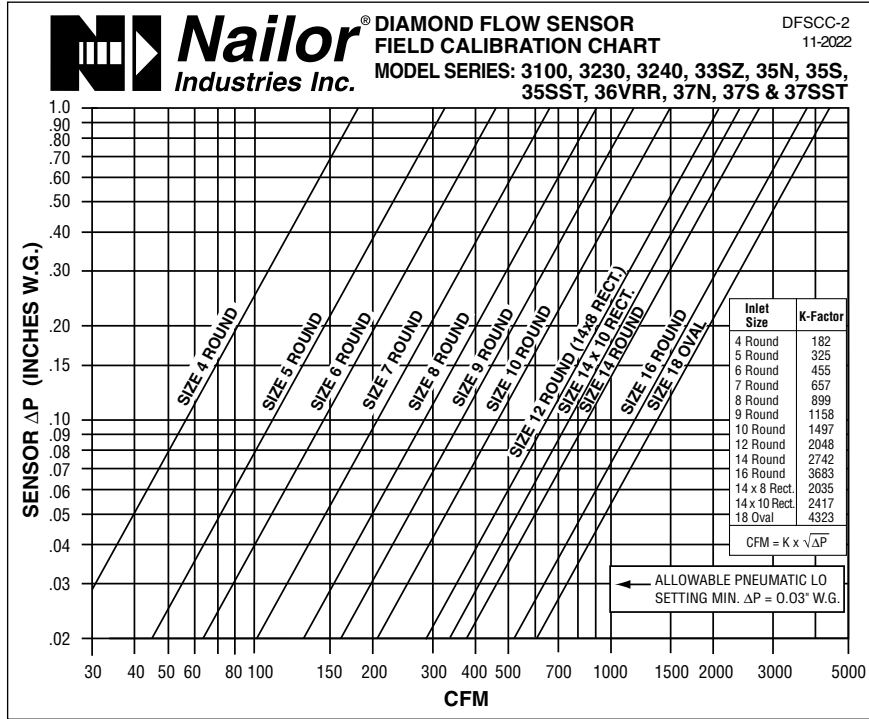

Application charts for ECM motors

Nailor Industries Inc. ECM MOTOR FAN CALIBRATION TABLE							
FAN POWERED TERMINAL UNIT							
MODEL SERIES: 33SZ - UNIT SIZE 50 • 120/208/230/277 VAC							
CFM	0-10 VDC REF.	CFM	0-10 VDC REF.	CFM	0-10 VDC REF.	CFM	0-10 VDC REF.
202	0.50	680	2.89	1140	5.29	1605	7.68
215	0.57	694	2.96	1153	5.36	1619	7.75
227	0.64	708	3.03	1167	5.43	1634	7.82
240	0.71	722	3.10	1180	5.50	1648	7.89
253	0.78	736	3.17	1193	5.57	1662	7.96
266	0.85	750	3.24	1206	5.64	1677	8.03
280	0.92	764	3.31	1220	5.71	1691	8.10
293	0.99	778	3.39	1233	5.78	1705	8.17
307	1.06	792	3.46	1246	5.85	1720	8.24
321	1.13	806	3.53	1259	5.92	1734	8.31
335	1.20	820	3.60	1273	5.99	1748	8.38
349	1.27	833	3.67	1286	6.06	1762	8.45
363	1.34	847	3.74	1300	6.13	1776	8.52
377	1.41	861	3.81	1313	6.20	1790	8.59
391	1.49	874	3.88	1327	6.27	1805	8.66
406	1.56	888	3.95	1340	6.34	1818	8.73
420	1.63	901	4.02	1354	6.41	1832	8.80
434	1.70	915	4.09	1367	6.48	1846	8.87
449	1.77	928	4.16	1381	6.55	1860	8.94
463	1.84	942	4.23	1395	6.62	1873	9.01
478	1.91	955	4.30	1408	6.69	1887	9.09
492	1.98	968	4.37	1422	6.76	1900	9.16
507	2.05	982	4.44	1436	6.83	1913	9.23
521	2.12	995	4.51	1450	6.90	1926	9.30
536	2.19	1008	4.58	1464	6.97	1939	9.37
550	2.26	1022	4.65	1478	7.04	1952	9.44
565	2.33	1035	4.72	1492	7.11	1964	9.51
579	2.40	1048	4.79	1506	7.19	1976	9.58
594	2.47	1061	4.86	1520	7.26	1988	9.65
608	2.54	1074	4.93	1534	7.33	2000	9.72
623	2.61	1088	5.00	1548	7.40	2011	9.79
637	2.68	1101	5.07	1562	7.47	2023	9.86
651	2.75	1114	5.14	1577	7.54	2033	9.93
666	2.82	1127	5.21	1591	7.61	2044	10.00

THIS UNIT HAS BEEN FACTORY SET AT _____ CFM.

RE-CALIBRATION IS NOT REQUIRED UNLESS THE ZONE DESIGN AIRFLOW REQUIREMENT HAS CHANGED. THE BOLD LINES INDICATE MIN AND MAX CFM FOR THE UNIT. IF OPERATING IN THE SHADED AREA AT LOW VOLUMES, VARIATIONS IN FLOW MAY BE GREATER THAN 5%. DATA REPRESENTED IN THIS CHART IS AT STANDARD CONDITIONS OF TEMPERATURE, PRESSURE AND HUMIDITY I.E. SCFM. FAN TURNS OFF BELOW 0.50Vdc.

www.nailor.com

Digital Control Algorithm:

CFM = -0.0457668(VDC)5 + 1.156314(VDC)4 - 10.34376(VDC)3 + 38.46166(VDC)2 + 143.28(VDC) + 122.205

VDC = 9.14193E-16(CFM)5 - 4.97944E-12(CFM)4 + 9.84127E-09(CFM)3 - 8.49E-06(CFM)2 + 8.12E-03(CFM) - 0.86954E+01

Airflow Direction (affixed to inlet collar)

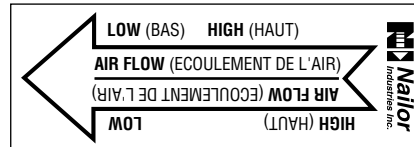

Model Series 33SZ Replacement Parts (P.1 of 2)

EPIC ECM MOTOR

Unit Size	RAPP Code	Description	Part Number	Program
10	MTR33SECMS1	ECM Motor 33S, Size 10, 120-277V, LH	H1-2267A	33SZ_Size10_LH
10	MTR33SECMS1B	ECM Motor 33S, Size 10, 120-277V, RH	H1-2267A	33SZ_Size10_RH
30	MTR33SECMS3	ECM Motor 33S, Size 30, 120-277V	H1-2269UA	33SZ_30ADSR
35	MTR33SECMS3B	ECM Motor 33S, Size 35, 120-277V	H1-2269UA (2)	33SZ_35ADSR
40	MTR33SECMS4	ECM Motor 33S, Size 40, 120-277V	H1-2269A	33SZ_40ADSR
50	MTR33SECMS5	ECM Motor 33S, Size 50, 120-277V	H1-2270A	33SZ_50ADSR
55	MTR33SECMS5B	ECM Motor 33S, Size 55, 120-277V	H1-2270A	33SZ_55ADSR

BLOWERS AND WHEELS

Unit Size	RAPP Code	Description	Part Number
10	BLW2119	Blower, Housing, 10.75X3.25, OL	H1-2119
10	BLW2120	Blower, Housing, 10.75X3.25, OR	H1-2120
30	BLW2427X	Blower, 11X4R, .5, CW, Dual Inlet, OL, OR	H1-2427X
35	BLW2427X	Blower, 11X4R, .5, CW, Dual Inlet, OL, OR	H1-2427X (2)
40	BLW0900X	Blower, 9X7R, .5, CW, Dual Inlet, OL, OR	H1-0900X
50, 55	BLW0903X	Blower, 10X10T, .5, CW, Dual Inlet, OL, OR	H1-0903X

WATER COILS

Unit Size	RAPP Code	Description	Part Number
10	V33SHWC110	HW Coil 33S 1 Row, Size 10	H1-2456
30	V33SHWC130	HW Coil 33S 1 Row, Size 30	H1-0094
35	V33SHWC135	HW Coil 33S 1 Row, Size 35	H1-0097
40	V33SHWC140	HW Coil 33S 1 Row, Size 40	H1-0987
50	V33SHWC150	HW Coil 33S 1 Row, Size 50	H1-0988
55	V33SHWC155	HW Coil 33S 1 Row, Size 55	H1-0988
10	V33SHWC210	HW Coil 33S 2 Row, Size 10	H1-2457
30	V33SHWC230	HW Coil 33S 2 Row, Size 30	H1-0095
35	V33SHWC235	HW Coil 33S 2 Row, Size 35	H1-0098
40	V33SHWC240	HW Coil 33S 2 Row, Size 40	H1-0926
50	V33SHWC250	HW Coil 33S 2 Row, Size 50	H1-0927
55	V33SHWC255	HW Coil 33S 2 Row, Size 55	H1-0927
10	V33SZWC210	CW Coil 33S 2 Row, Size 10, w/drip pan	H1-2453A
30	V33SZWC230	CW Coil 33S 2 Row, Size 30, w/drip pan	H1-2458
35	V33SZWC235	CW Coil 33S 2 Row, Size 35, w/drip pan	H1-2924
40	V33SZWC240	CW Coil 33S 2 Row, Size 40, w/drip pan	H1-2462
50	V33SZWC250	CW Coil 33S 2 Row, Size 50, w/drip pan	H1-2468
55	V33SZWC255	CW Coil 33S 2 Row, Size 55, w/drip pan	H1-2468
10	V33SZWC410	CW Coil 33S 4 Row, Size 10, w/drip pan	H1-2454A
30	V33SZWC430	CW Coil 33S 4 Row, Size 30, w/drip pan	H1-2459
35	V33SZWC435	CW Coil 33S 4 Row, Size 35, w/drip pan	H1-2925
40	V33SZWC440	CW Coil 33S 4 Row, Size 40, w/drip pan	H1-2463
50	V33SZWC450	CW Coil 33S 4 Row, Size 50, w/drip pan	H1-2469
55	V33SZWC455	CW Coil 33S 4 Row, Size 55, w/drip pan	H1-2920
10	V33SZWC610	CW Coil 33S 6 Row, Size 10, w/drip pan	H1-2455A
30	V33SZWC630	CW Coil 33S 6 Row, Size 30, w/drip pan	H1-2460
35	V33SZWC635	CW Coil 33S 6 Row, Size 35, w/drip pan	H1-2923
40	V33SZWC640	CW Coil 33S 6 Row, Size 40, w/drip pan	H1-2464
50	V33SZWC650	CW Coil 33S 6 Row, Size 50, w/drip pan	H1-2470
55	V33SZWC655	CW Coil 33S 6 Row, Size 55, w/drip pan	H1-2470A
10	V33SZWC810	CW Coil 33S 8 Row, Size 10, w/drip pan	H1-3076
30	V33SZWC830	CW Coil 33S 8 Row, Size 30, w/drip pan	H1-2460A
35	V33SZWC835	CW Coil 33S 8 Row, Size 35, w/drip pan	H1-2926
40	V33SZWC840	CW Coil 33S 8 Row, Size 40, w/drip pan	H1-2932
50	V33SZWC850	CW Coil 33S 8 Row, Size 50, w/drip pan	H1-2470E
55	V33SZWC855	CW Coil 33S 8 Row, Size 55, w/drip pan	H1-2921

FILTERS

Unit Size	RAPP Code	Description	Part Number
10	VH1-2502A	Filter 1" 8.5x45	H1-2502A
	VH1-2503A	Filter 2" MERV8 8.5x45	H1-2503A
	VH1-2504A	Filter 2" MERV13 8.5x45	H1-2504A
30	VH1-2506	Filter 1" 10x38	H1-2506
	VH1-2507	Filter 2" MERV8 10x38	H1-2507
	VH1-2508	Filter 2" MERV13 10x38	H1-2508
35	VH1-2506A	Filter 1" 52x10	H1-2506A
	VH1-2507A	Filter 2" MERV8 52x10	H1-2507A
	VH1-2508A	Filter 2" MERV13 52x10	H1-2508A
40	VH1-2509	Filter 1" 16x33	H1-2509
	VH1-2510	Filter 2" MERV8 16x33	H1-2510
	VH1-2511	Filter 2" MERV13 16x33	H1-2511
50	VH1-2512	Filter 1" 16x38	H1-2512
	VH1-2513	Filter 2" MERV8 16x38	H1-2513
	VH1-2514	Filter 2" MERV13 16x38	H1-2514
55	VH1-2512A	Filter 1" 16x52	H1-2512A
	VH1-2513A	Filter 2" MERV8 16x52	H1-2513A
	VH1-2340	Filter 2" MERV13 16x52	H1-2340

Model Series 33SZ Replacement Parts (P.2 of 2)

ELECTRICAL COMPONENTS

RAPP Code	Description	Part Number
Disconnect Switches		
EC-DISTG251P	Toggle Disconnect Switch 1P,600V,25A	H1-0212A
EC-DISTG403P	Toggle Disconnect Switch 3P,600V,40A	H1-0220Z
EC-DISTG603P	Toggle Disconnect Switch 3P,600V,60A	H1-0221Z
EC-DISINT25A	Interlocking Disconnect Switch3P,600V,25A	H1-0215Z
EC-DISINT40A	Interlocking Disconnect Switch3P,600V,40A	H1-0216Z
EC-DISINT60A	Interlocking Disconnect Switch3P,600V,60A	H1-0217Z
EC-DISINTHDL	Interlocking Disconnect Handle	H1-0215C
EC-DISINTSFT	Interlocking Disconnect Shaft	H1-0215D
Contactors		
EC-CONM50A1P	Contactore MAG 1P,600V,50Amp	H1-0635
EC-CONM40A1P	Contactore MAG 1P,600V,40Amp	H1-0636
EC-CONM30A1P	Contactore MAG 1P,600V,30Amp	H1-0654
EC-CONM50A2P	Contactore MAG 2P,600V,50Amp	H1-0658
EC-CONM40A2P	Contactore MAG 2P,600V,40Amp	H1-0655
EC-CONM30A2P	Contactore MAG 2P,600V,30Amp	H1-0652
EC-CONM50A3P	Contactore MAG 3P,600V,50Amp	H1-0640
EC-CONM40A3P	Contactore MAG 3P,600V,40Amp	H1-0639
EC-CONM30A3P	Contactore MAG 3P,600V,30Amp	H1-0653
SCR/SSR		
EC-SCR	SCR Elect. Heat controller, 600V, 1ph, 45A	H1-2064
EC-SSR	SSR Elect. Heat controller, 600V, 1ph, 45A	H1-2082
ECM Cards		
EC-ECMC	Single ECM Motor Control Card	H1-2272
EC-ECMCA	Single ECM Motor Control Card w/ Fan	H1-2272A1
EC-ECMC2	Dual ECM Motor Control Card	H1-2273A1
ECM Motor Wiring harness		
EC-HARNESS1	Wiring Harness, Card to ECM. 16 Pin	H1-1104
EC-HARNESS2	Wiring Harness Power to Motor. 5 Pin	H1-1101
EC-HARNESS3	0-10 VDC wiring harness, 2 Pin	H1-1921
EC-HARNESS4	0-10 VDC wiring harness, 4 Pin, 2W	H1-1921A
	0-10 VDC wiring harness, 4 Pin, 4W	H1-1921H
Transformers		
EC-TRANS120A	Transformer 120V,24V,50VA	H1-0692
EC-TRANS208A	Transformer 208-240V,24V,50VA	H1-0685
EC-TRANS277A	Transformer 277V,24V,50VA	H1-0674
EC-TRANS480A	Transformer 480V,24V,50VA	H1-0686
EC-TRANS2424	Isolation Transformer 24V,24V,50VA	H1-0673
EC-TRANSB	Transformer 120V/208/240/480 to 24V,75VA	H1-0689
EC-TRANS277B	Transformer 277V,24V,75VA	H1-0677
MISC		
EC-AFSW	Airflow Switch	H1-0236A
EC-AFSWPB	Airflow Switch Probe 4"	H1-0242
EC-AFSWPBL	Airflow Switch Probe 6"	H1-1924
EC-AUTOLMTSW	Auto Temp. LMT Switch	H1-0006
EC-MANLMTSW	Manual Temp. LMT Switch	H1-0805
EC-FANRELAY	Fan Relay 24V	H1-0666

ELECTRIC CONTROLS - Transformers

Description	Code
120 to 24 v. 20VA - foot mount	V2070
- 4" x 4" elec. box	V2071
120 to 24 v. 40VA - foot mount	V2072
- 4" x 4" elec. box	V2073
208/240 to 24 v. 40VA - foot mount	V2074
277 to 24 v. 40VA - foot mount	V2075
24 to 24 v. 40VA - foot mount	V2076

FUSE/FUSE BLOCKS

RAPP Code	Description	Part Number
EC-FSBLK1PA	Fuseblock, 1P, 250V, 30A	H1-0016
EC-FSBLK1PB	Fuseblock, 1P, 250V, 60A	H1-0263
EC-FSBLK1PC	Fuseblock, 1P, 600V, 30A	H1-0973
EC-FSBLK1PD	Fuseblock, 1P, 600V, 60A	H1-0269A
EC-FSBLK2PA	Fuseblock, 2P, 250V, 30A	H1-0920
EC-FSBLK2PC	Fuseblock, 2P, 600V, 30A	H1-0264
EC-FSBLK2PD	Fuseblock, 2P, 600V, 60A	H1-0269B
EC-FSBLK3PA	Fuseblock, 3P, 250V, 30A	H1-0265
EC-FSBLK3PB	Fuseblock, 3P, 250V, 60A	H1-0266
EC-FSBLK3PC	Fuseblock, 3P, 600V, 30A	H1-0268
EC-FSBLK3PD	Fuseblock, 3P, 600V, 60A	H1-0269
EC-FUS250V15	Fuse, 250V, 15A	H1-0320A
EC-FUS250V20	Fuse, 250V, 20A	H1-0321A
EC-FUS250V25	Fuse, 250V, 25A	H1-0322A
EC-FUS250V30	Fuse, 250V, 30A	H1-0323A
EC-FUS250V35	Fuse, 250V, 35A	H1-0324A
EC-FUS250V40	Fuse, 250V, 40A	H1-0325A
EC-FUS250V45	Fuse, 250V, 45A	H1-0326A
EC-FUS250V50	Fuse, 250V, 50A	H1-0327A
EC-FUS250V60	Fuse, 250V, 60A	H1-0328A
EC-FUS600V15	Fuse, 600V, 15A	H1-0329A
EC-FUS600V20	Fuse, 600V, 20A	H1-0330A
EC-FUS600V25	Fuse, 600V, 25A	H1-0331A
EC-FUS600V30	Fuse, 600V, 30A	H1-0332A
EC-FUS600V35	Fuse, 600V, 35A	H1-0333A
EC-FUS600V40	Fuse, 600V, 40A	H1-0334A
EC-FUS600V45	Fuse, 600V, 45A	H1-0335A
EC-FUS600V50	Fuse, 600V, 50A	H1-0336A
EC-FUS600V60	Fuse, 600V, 60A	H1-0337A

Appendix A – MCA and MOP Calculations

Minimum Circuit Ampacity

$$\text{MCA} = 1.25 \times (\text{Load 1} + \text{Load 2} + \text{Load 3} + \text{Load 4})$$

Maximum Overcurrent Protection

$$\text{MOP} = (2.25 \times \text{load 1}) + \text{load 2} + \text{load 3} + \text{load 4}$$

If the calculated MOP does not equal the standard current rating of an overcurrent protective device (typically even multiples of 5), then the marked MOP is the next lower standard rating.

Exceptions:

1. The marked MOP will be the next higher standard rating than the computed value, if the n Control Card ext lower standard rating is less than 125 percent of the current rating of an electric heater load when such heater is involved.
2. If the computed value for MOP is less than the MCA, then the marked MOP is increased to the largest MOP appropriate for the MCA.
3. If the MCA does not correspond to a standard protective device rating, the next higher standard rating of the protective device will be marked if this rating does not exceed 800 A.

For Nailor Fan Powered Terminal Units and Fan Powered Chilled Water Terminal Units, **Load 1** is the largest motor current, **Load 2** is the sum of all other motor currents, and **Load 3** is the heater current. **Load 4** is used for other loads greater than 1.0 ampere and can be considered zero for most standard products.

For Nailor Variable Air Volume Units, **Load 1** and **Load 2** are considered zero.

Load 3 is the heater current **Load 4** is used for other loads greater than 1.0 ampere and can be considered zero for most standard products.

(Motor currents are determined by product application test in accordance with UL 1995 and may not be the same as the motor manufacturer's FLA marking.)

All formulae, definitions, and exceptions are cited from Underwriters Laboratories Inc. Standard for Safety for Heating and Cooling Equipment, UL 1995 Fourth Edition (Sec. 37.14, 37.15) CAN/CSA-C22.2 No. 236 Fourth Edition

Model 33SZ • Orientations

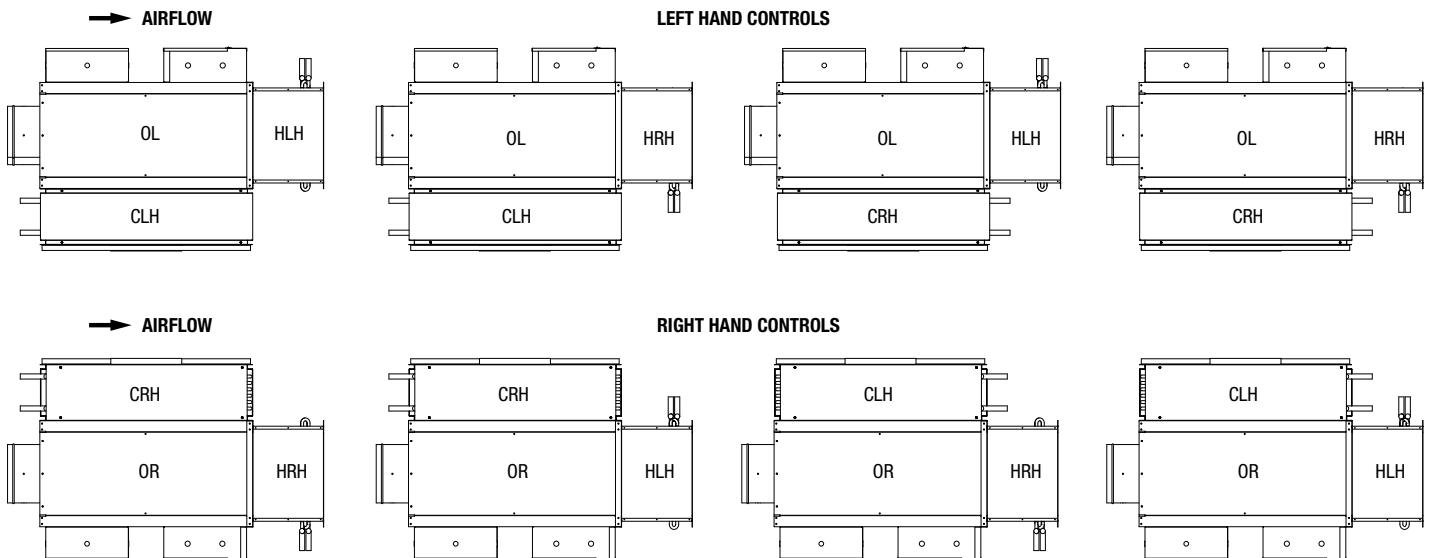

Model 33SZE • Size 40-50

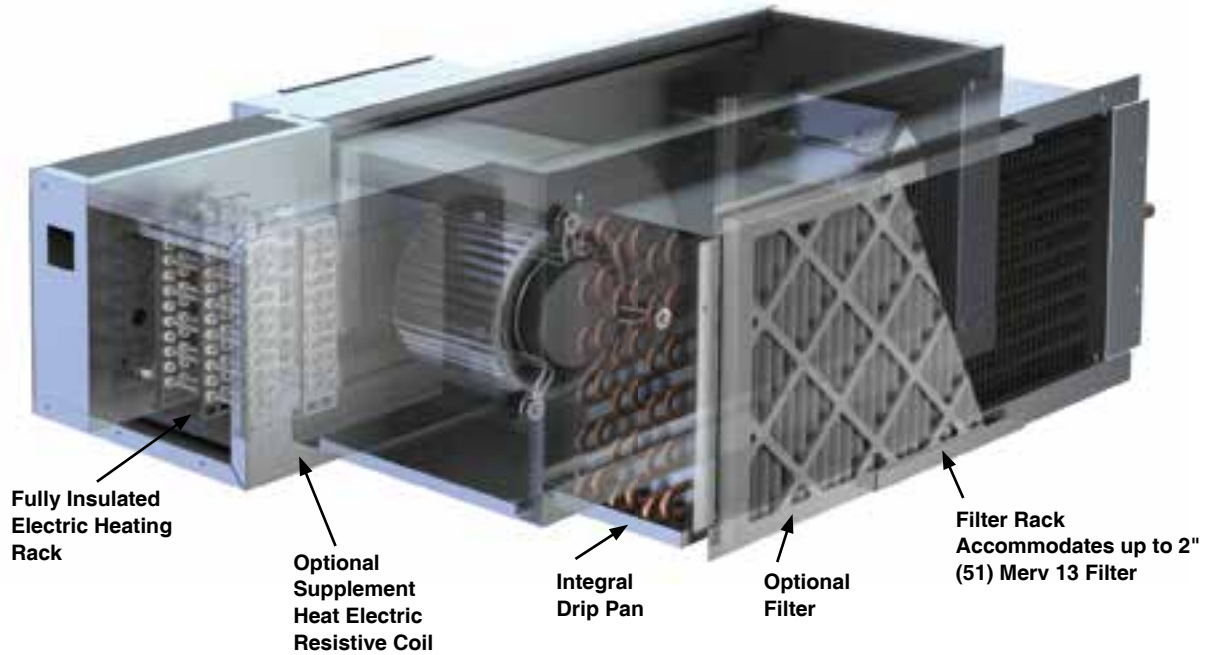

Model 33SZW • Size 40-50

