



IOM

Installation and Operation Manual

EZvav Digital Controls



www.nailor.com



Date: 7-2016

Supersedes: 6-2016

IOM-EZVAVINST

Nailor reserves the right to change any information concerning product or specification without notice or obligation.



CONTENTS

SECTION 1: About the controllers 4

 Specifications 5

 Safety considerations 7

SECTION 2: Installing the controllers. 7

 Setting the rotation limits. 7

 Mounting on a VAV Terminal Unit 8

 Connecting an airflow sensor 9

 Connecting inputs and outputs 9

 Connecting room temperature sensors 9

 Connecting a DAT sensor. 10

 Connecting power 10

 Maintenance 10

SECTION 3: Installing the Room Sensors. 11

 Choosing a sensor location 11

 Rough-in preparation 11

 Mount the sensors 11

 Operation. 12

 Maintenance 12

 Planning got motion sensing 12

SECTION 4: Changing the room set point 13

SECTION 5: Configuring the controllers. 14

 Getting started with configuration. 14

 Entering system temperature set points and limits 15

 Configuring the VAV Terminal Unit options 17

 Set the airflow set points 19

 Advanced options 21

 Restore application 23

SECTION 6: Balancing airflow 24

 Quick start configuration guide - EZvav sensors & controllers 28

CONTENTS (Con't)

SECTION 7: Application drawings	29
Cooling or heating without reheat	29
Staged reheat	30
Modulating reheat	31
Floating reheat	32
Dual-duct application	33
SECTION 8: Sequences of operation	34
Input sources	34
Occupancy sequence	35
Space set points	35
PID control loops	36
Airflow Set points Sequence	36
Changeover	36
Discharge Air Temperature (DAT) limiting	37
System diagnostics	37
Damper operation	38
Fan operation	38
Reheat sequence	39
Balancing airflow sequence	40
Dual duct	40
SECTION 9: System integration and networking	41
Connecting to an MS/TP network	41
Setting up network communications	42
BACnet objects	44
ADDITIONAL TOPICS	
Diamond flow sensor K-factors for VAV Terminal Units	47
Accessories and replacement parts	48

Section 1: About the Controllers

This section provides a description of the EZvav series of controllers. It also introduces safety information. Review this material before selecting, installing, or operating the controllers.

The EZvav series of controllers are an easy and unique approach to operating a wide variety of VAV terminal units. The integrated actuators, internal airflow sensors, and wide variety of application programs make these BACnet Application Specific controllers ideal for either new or retrofit installations.

The controllers feature simple, menu driven setup choices when used with a EZvav digital sensor. No special programming skills or software tools are required to choose applications, enter set points, set network addressing, and balance airflow. All options can be set by using a STE-8001W36 sensor and can be installed as the permanent room sensor or temporarily connected as a technician’s service tool.

All models are BACnet Application Specific Controllers that are ready to connect to a BACnet MS/TP network. Device instance, MAC address, and baud rate are set from an STE-8001W36 without special software.

Model BAC-8001-36 is supplied with inputs, outputs, and sequences of operation for the following functions.

- Single duct heating and cooling VAV.
- Automatic heating/cooling changeover including morning warm up.
- Occupancy setback—requires STE-8201W36.
- System diagnostic indicators.
- Airflow balancing.

Model BAC-8005-36 and **BAC-8205-36** are supplied with inputs, outputs, and sequences of operation for the following functions.

- Single duct heating and cooling VAV.
- Modulating, floating, and staged reheat.
- Series and parallel fan control.
- Automatic heating/cooling changeover including morning warm up.
- Discharge air temperature limiting.
- Occupancy setback—requires STE-8201W36.
- Actuator position feedback for true damper positioning (BAC-8205-36 only).
- System diagnostic indicators.
- Airflow balancing.

Model BAC-8007-36 is supplied with inputs, outputs, and sequences of operation for the following functions.

- Dual duct VAV heating and cooling.
- Occupancy setback—requires STE-8201W36.
- System diagnostic indicators.
- Airflow balancing.

Additional topics in this section

Specifications	5
Safety considerations.....	7

Specifications

EZvav specifications are subject to change without notice.

Inputs and outputs

All inputs and outputs are factory programmed and application specific. No field configuration is required. For details on input and output connections, see the topic Application drawings on page 29. For a detailed listing of input and output objects, see the topic BACnet objects on 44.

Analog inputs

Analog inputs represent BACnet analog input. Not all input are applicable or required for all models.

Key features	IP/SI standard units of measure. Overvoltage input protection
Connectors	RJ-45 room sensor jack Screw terminals for wire sizes 12 – 26 AWG
Conversion	12 – bit analog-to-digital conversion
Input range	Passive, 10 k Ω pull-up to 3.3 volts DC

Analog outputs

Analog outputs are configured to represent BACnet analog output objects. No field configuration is required. For details on application specific output connections see the section Application drawings on page 29.

Key features	Output short protection IP/SI standard units of measure
Connector	Screw terminals for wire size 12 – 26 AWG
Conversion	12 – bit digital-to-analog conversion
Output voltage	0 – 10 VDC
Output current	30 mA per output, 30 mA total for all analog outputs

Binary outputs

Binary outputs are configured to represent BACnet binary output objects. No field configuration is required. For details on application specific output connections see the section Application drawings on page 29.

Key features	Optically isolated triac output
Connector	Screw terminals for wire size 12 – 26 AWG
Output range	Maximum switching 24 Volts AC 1 ampere per external output, 3 amperes total

Communications—BACnet MS/TP

- EIA – 485 operating at rates up to 76.8 kilobaud.
- Removable screw terminal block.
- Wire size 12 – 26 AWG.
- Switch selected end of line termination.

Memory

- Programs and program parameters are stored in nonvolatile memory.
- Auto restart on power failure.

Air flow sensor features

- Configured as BACnet analog input object.
- CMOS differential pressure 0 – 2 inches of water (0 – 500 Pa) measurement range. Internally linearized and temperature compensated.
- Span accuracy 4.5% of reading.
- Zero point accuracy 0.0008 in. H₂O/0.2 Pa at 77°F (25°C).
- Barbed connections for 1/4 inch (6.35 mm) FR tubing.

Installation and Operation Manual • EZvav Digital Controls

Actuator Specifications

Torque	40 in-lb. (4.5 N.m)
Angular rotation	0 to 95° Adjustable end stops at 45° and 60° rotation
Motor timing	90 sec./90° at 60 Hz
BAC-8001-36, BAC-8005-36, BAC-8007-36	108 sec./90° at 50 Hz
Motor timing BAC-8205-36	60 sec./90° at 60 Hz
Shaft size	Directly mounts on 3/8 to 5/8 inch (9.5 to 16 mm) round or 3/8 to 7/16 inch (9.5 to 11 mm) square damper shafts.

Regulatory

- UL 916 Energy Management Equipment.
- BACnet Testing Laboratory listed as an application specific controller (ASC).
- CE compliant.
- SASO PCP Registration KSA R-103263.
- FCC Class B, Part 15, Subpart B and complies with Canadian ICES-003 Class B.

This device complies with part 15 of the FCC Rules. Operation is subject to the following two conditions: (1) This device may not cause harmful interference, and (2) this device must accept any interference received, including interference that may cause undesired operation.

Installation

Supply voltage	24 volts AC, -15%, +20% 5 VA, 50/60 Hz
Weight	13.2 ounces (376 grams)
Case material	Flame retardant plastic

Environmental limits

Operating	32 to 120° F (0 to 49° C)
Shipping	-40 to 140° F (-40 to 60° C)
Humidity	5 – 93% relative humidity (non condensing)

Dimensions

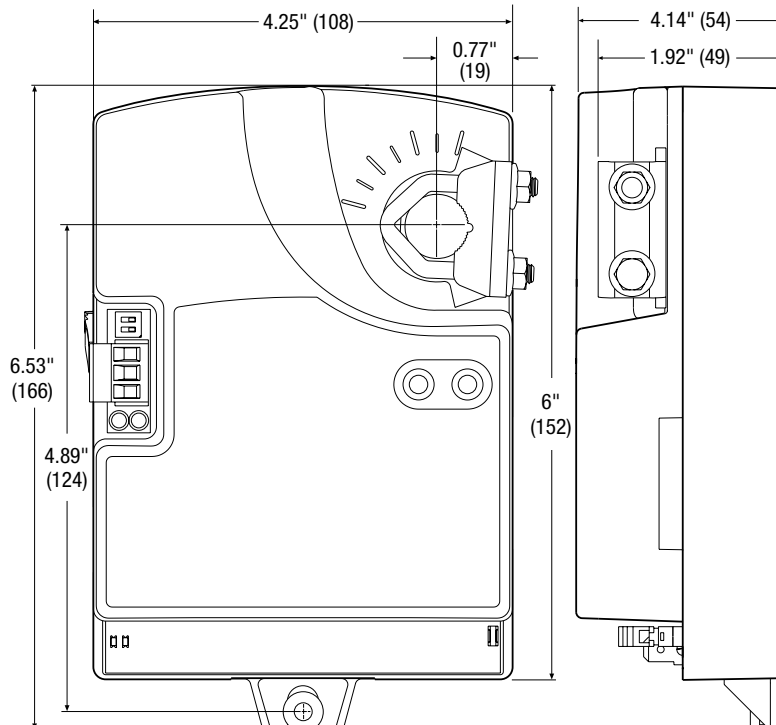

Safety Considerations

Nailor assumes the responsibility for providing you a safe product and safety guidelines during its use. Safety means protection to all individuals who install, operate, and service the equipment as well as protection of the equipment itself. To promote safety, we use hazard alert labeling in this manual. Follow the associated guidelines to avoid hazards.



DANGER represents the most severe hazard alert. Bodily harm or death will occur if danger guidelines are not followed.



WARNING represents hazards that could result in severe injury or death.



CAUTION indicates potential personal injury or equipment or property damage if instructions are not followed.

Note: Notes provide additional information that is important.

Tip: Provides programing tips and shortcuts that may save time.

Section 2: Installing the Controllers

This section provides important instructions and guidelines for installing the Nailor EZvav controllers. Carefully review this information before installing the controller.

Installing Nailor EZvav includes the following topics that are covered in this section.

Installation topics in this section

Setting the rotation limits	7
Mounting on a VAV terminal box.....	8
Connecting an airflow sensor	9
Connecting inputs and outputs	9
Connecting room temperature sensors.....	9
Connecting a DAT sensor	10
Connecting power.....	10
Maintenance.....	10

Setting the Rotation Limits

Nailor EZvav controllers are manufactured for a damper that rotates 90 degrees from open to close. If the VAV damper is not a 90 degree damper, set the rotation limits to 45 or 60 degrees before mounting the controller.



CAUTION Setting rotation limits that do not match the VAV damper may result in improper operation or equipment damage.

Figure 2-1 Controller rotation limit selections

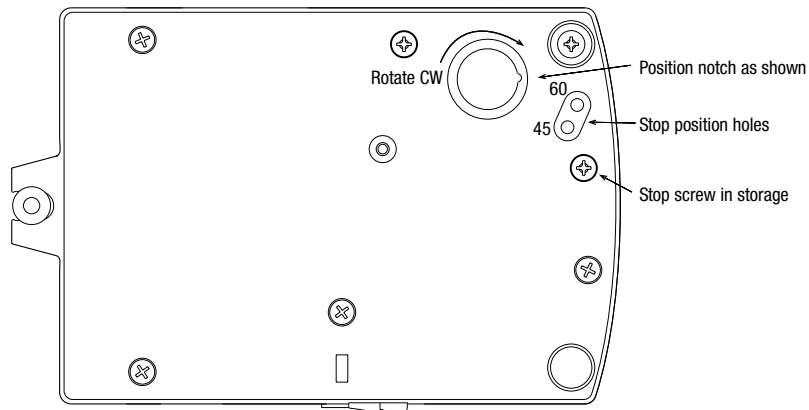

To set the rotational limits, do the following:

1. Turn the controller over so you have access to the back.
2. Manually rotate the actuator fully clockwise as viewed from the back.
3. Remove the stop screw from its storage location and clean any debris from the threads.
4. Insert the screw into the correct stop position hole.
5. Tighten the screw only until the head touches the plastic in the bottom of the recess.

Mounting on a VAV Terminal Unit

Mount the controller inside of a metal enclosure. To maintain RF emissions specifications, use either shielded connecting cables or enclose all cables in conduit.

Mount the controller directly over the damper shaft. A minimum shaft length of 2.0 inch (51 mm) is required.

Note: Nailor EZvav controllers are designed to directly mount to 3/8 to 5/8 inch (9.5 to 16 mm) round or 3/8 to 7/16 inch (9.5 to 11 mm) square damper shafts.

Figure 2-2 Control and indicators

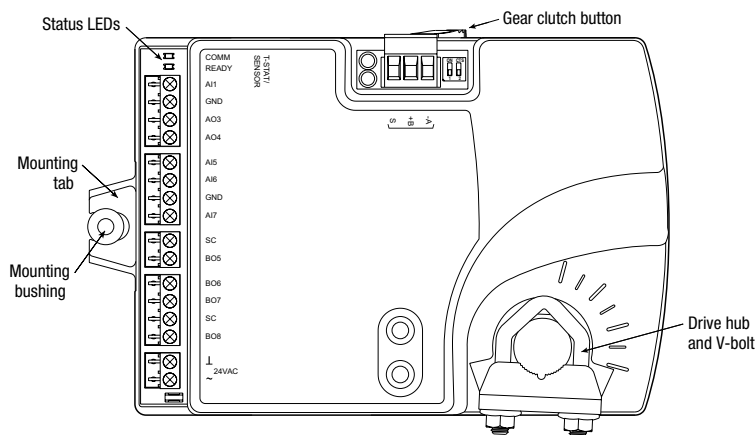

Mount the controller as follows:

1. Manually rotate the damper on the VAV box to the fully closed position.
2. On the controller, press the gear clutch button and rotate the drive hub in the same direction that closed the damper. Turn the hub until it reaches a rotation limit, then rotate 2° in the opposite direction and release clutch.
3. Loosen the nuts on the V-bolt until the damper shaft can fit through the collar.
4. Place the controller over the damper shaft.
5. Finger tighten the nuts on the V-bolt to position the shaft in the drive hub
6. Center the mounting bushing in the mounting tab and fasten it with a #8 sheet metal screw.
7. Evenly tighten the V-bolt nuts on the drive hub to 30-35 in-lbs (3.34 – 3.95 N.m).

Connecting an Airflow Sensor

An airflow sensor is incorporated as one of the inputs to the controller. Remove the plugs and connect the tubing from the pitot assembly to the airflow sensor inputs next to the drive hub.

Figure 2-3 Airflow sensor inputs

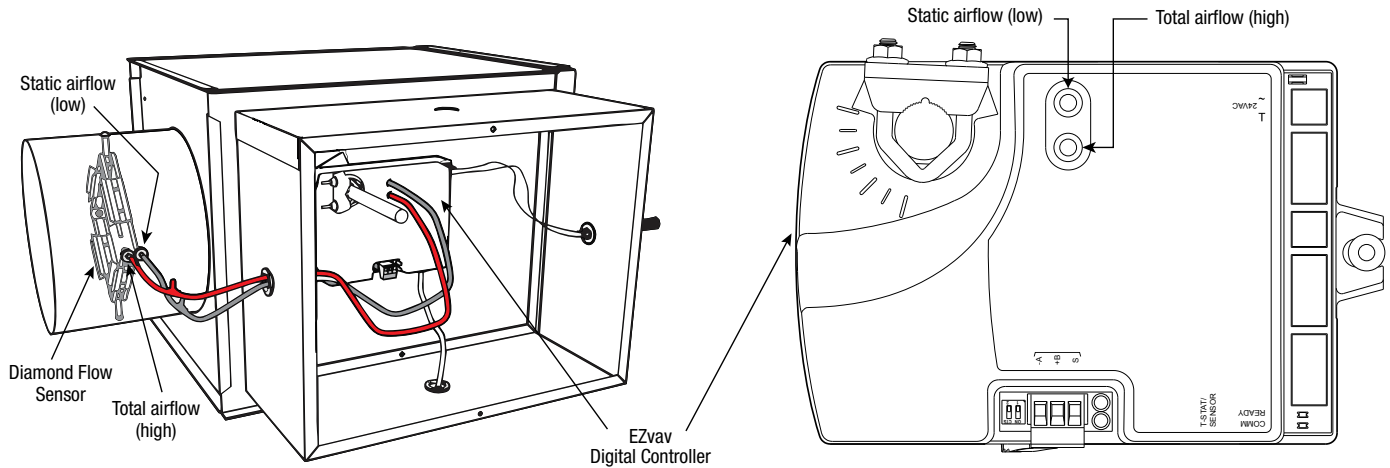

Diamond flow sensors are supplied by Nailor as part of the VAV terminal unit. If a sensor is needed, choose a sensor listed in the topic Accessories and Replacement Parts on page 48. For more information on Nailor’s ‘Diamond Flow’ Sensor, see page 48 or refer to Nailor website.

Connecting Inputs and Outputs

Nailor EZvav series controllers have preconfigured inputs and outputs to support only the supplied programs and applications.

- For input and output connection information, see the topic Application drawings on page 29.
- To connect room temperature sensors, see the topic Connecting room temperature sensors on page 9.
- To connect a DAT sensor, see the topic Connecting a DAT sensor on page 10.
- For the BACnet object descriptions of the inputs and outputs, see the topic BACnet objects on page 44.

Connecting Room Temperature Sensors

Connect any of the following sensors to the RJ-45 thermostat and sensor jack. The controller automatically detects the type of sensor. No programming or configuration is required.

- STE-6014W36
- STE-8001W36
- STE-8201W36

Connect the controller to sensors with standard Ethernet cables up to 75 feet long.

Figure 2-4 Connecting to a sensor

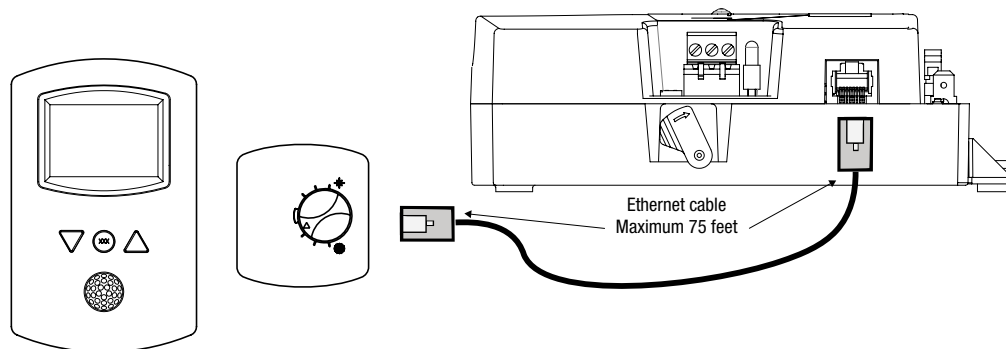

Connecting a DAT Sensor

The Discharge Air Temperature sensor is required for automatic changeover and for VAV terminal units with reheat.

Figure 2-5 Discharge air temperature sensor location

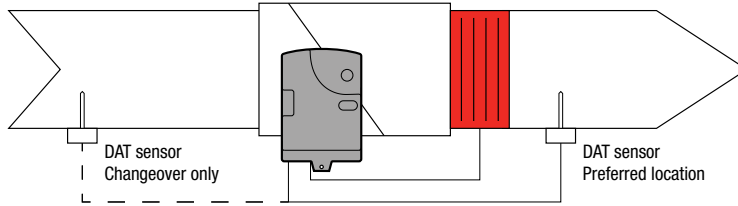

Connect a 10 kΩ, Type 3 thermistor temperature probe to the discharge air temperature input. The input includes the internal pull-up resistor. An STE-1401 sensor is suitable for this application. Follow the instructions supplied with the sensor for installation, or refer to pages 11-12 for this information.

- For DAT limiting and reheat, install the sensor in the airflow after the reheat section. See the topic, Advanced options on page 21 to enable discharge air temperature control.
- When the DAT sensor is used only to detect primary air temperature, the sensor can be placed in either location shown in the Figure Discharge air temperature sensor location.

Figure 2-6 Discharge air temperature input details

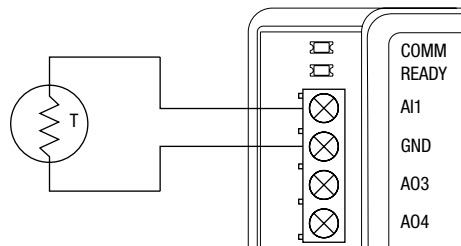

Connecting Power

The controllers require a 24 volt, AC power source. Use the following guidelines when choosing and wiring transformers to the controller.

- A Class – 2 transformer is supplied with each unit.

Connect the 24 volt AC power supply to the power terminal block on the lower right side of the controller. Connect the ground side of the transformer to the ground terminal and the AC phase to the phase terminal. Power is applied to the controller when the transformer is connected to power.

Figure 2-7 Controller power terminals

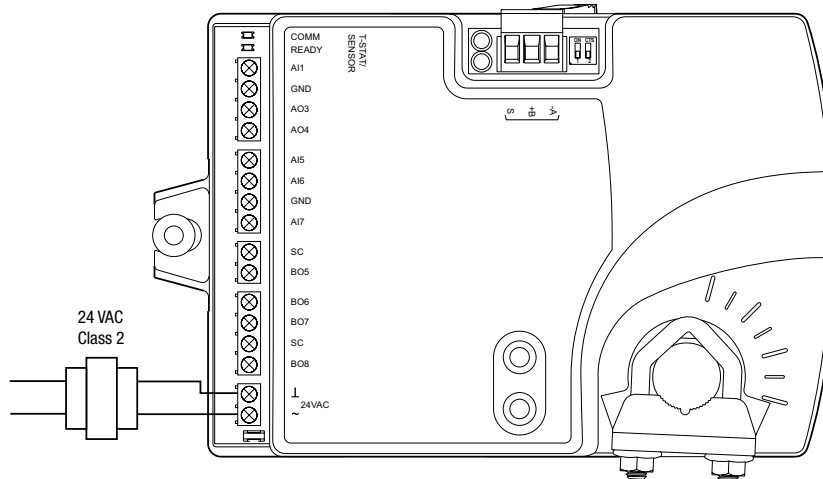

Maintenance

Nailor EZvav controllers require no routine maintenance. If necessary, clean with a damp cloth and mild soap.

Section 3: Installing the Room Sensors

An airflow sensor is incorporated as one of the inputs to the controller. Remove the plugs and connect the tubing from the pitot assembly to the airflow sensor inputs next to the drive hub.

EZvav Sensors:

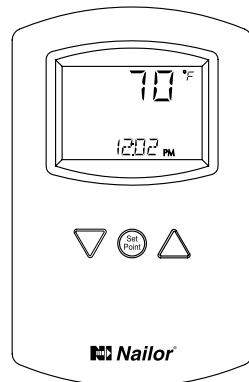

STE-8001W36
Digital Display

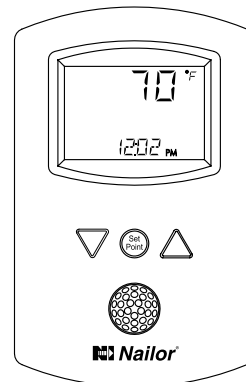

STE-8201W36
Digital Display with Occupancy Sensor

This applies to EZvav digital display wall sensors connected to EZvav controllers.

Choosing a sensor location

Install the sensor on an inside wall where it can sense the average room temperature. Avoid locations with direct sunlight, heat sources, windows, air vents, and air circulation obstructions such as curtains or furniture.

For models with motion sensing, see the topic on the page 12, Planning for motion sensing.

Rough-in preparation

Complete rough-in wiring at each sensor location prior to sensor installation. This includes the following items:

- If required, install an appropriate backplate.
- Route an Ethernet connecting cable from the sensor to the controller location.
- Maximum cable length is 75 feet (22.9 meters). Plenum-rated preassembled cables are recommended.

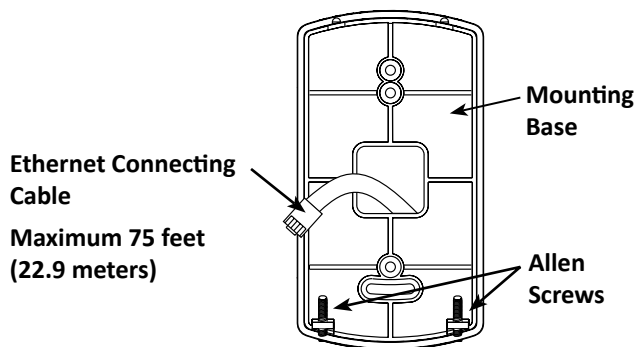

Mount the sensors

To install the sensor on a mounting base, do the following:

1. Turn the Allen screws in the base of the sensor clockwise until they clear the case. Swing the sensor away from the mounting base to remove it.

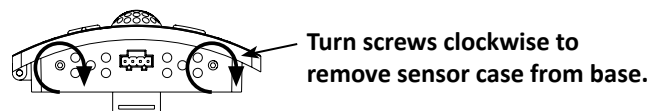

Installation and Operation Manual • EZvav Digital Controls

2. Route the Ethernet cable through the mounting base.
3. Fasten the mounting base directly to a 2 x 4 inch (51 x 102 mm) outlet box or a backplate with the Allen screws toward the floor.
4. Insert the Ethernet cable coming from the base into the sensor.
5. Place the top of the sensor over the top of the mounting base and swing it down over the Allen screw brackets. Be careful not to pinch any wiring.
6. Turn the Allen screws counterclockwise until they back out of the mounting base and engage the case of the sensor.

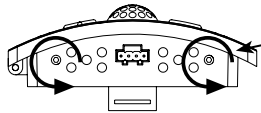

Turn counterclockwise until the screws engage the case.

Operation

The sensor will become operational as soon as it is connected to an operational controller. See the following pages to change room set points or configure a EZvav controller with the sensor.

Maintenance

Remove dust as necessary from holes in top and bottom. Clean the display with soft, damp cloth and mild soap.

Planning for motion sensing

For motion sensing models only — Mount the sensor on a wall that will have an unobstructed view of the typical traffic in the coverage area. When choosing a location, do not install the sensor in the following areas.

- Behind curtains or other obstructions.
- In locations that will expose it to direct sunlight or heat sources.
- Near a heating or cooling inlet or outlet.

The effective detection range is approximately 33 feet (10 meters). Factors that may reduce the range may include the following items.

- The difference between the surface temperature of the object and the background temperature of the room is too small.
- Object movement in a direct line toward the sensor.
- Very slow or very fast object movement.
- Obstructions in the shaded area of the diagram
Typical motion sensing coverage.

False detections may be triggered by any of the following conditions.

- The temperature inside the detection range suddenly changes because of the entry of cold or warm air from an air-conditioning or heating unit.
- The sensor being directly exposed to sunlight, an incandescent light, or other source of far-infrared rays.
- Small animal movement.

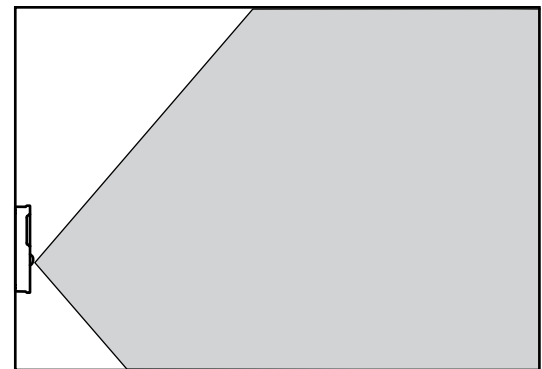

Typical motion sensing coverage

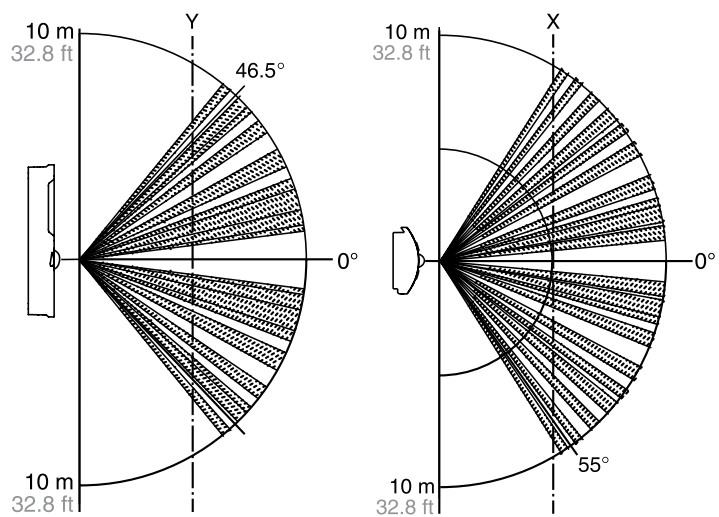

Side view

Top view

Motion sensor vertical and horizontal patterns

Section 4: Changing the Room Set Point

This section covers topics for the end user.

Changing the EZvav user functions with an STE-8001W36 or STE-8201W36 are limited to changing the active set points in a room. The set points are entered or changed using the buttons and display on the front of the sensor.

Quick start to changing set points



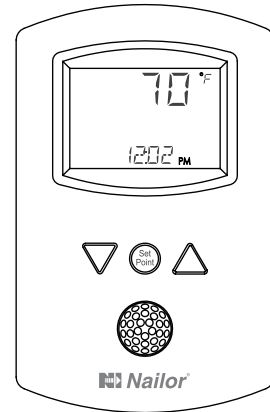



1. Press any button to begin changing set points.
2. If required, enter Password 1.
3. Press the up Δ or down ∇ buttons to change a set point value.
4. Press the  button to save the value or advance to the next function.

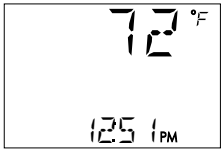

To enter or change the active set points you may need Password 1 .

Tip: *Once the following procedure is started, all steps must be completed in order.*

Changing Room Set Points

PROCEDURE	STEPS	STE DISPLAY
1 Starting display	Start from the temperature display.	
2 Enter Password 1	<ol style="list-style-type: none"> 1. Press any button. The display changes to P S W 1 . 2. Press the Δ or ∇ buttons to change the first digit. 3. Press the  button to select the next digit. Repeat for all four digits. <p>Note: <i>If Password 1 has not previously been entered, the display will change to the occupied cooling set point display after Step 1.</i></p>	
3 Set the active cooling set point.	<ol style="list-style-type: none"> 1. Press the Δ or ∇ buttons to change the cooling set point temperature. The set point changes in increments of 0.5 degrees. 2. Press the  button to save the value. The display advances to set the heating set point. 	
4 Set the active heating set point.	<ol style="list-style-type: none"> 1. Press the Δ or ∇ buttons to change the heating set point temperature. The set point changes in increments of 0.5 degrees. 2. Press the  button to save the value. The display returns to the temperature display. 	

Section 5: Configuring the Controllers

This topics in this section are advanced topics for control technicians and engineers.

The configuration functions that are accessible through an STE-8000 series sensor are all of the values and settings that are entered during the installation and commissioning of a VAV terminal unit. Typically, these functions do not change after the installation and commissioning process.

To set up the configuration functions, you will need the following items and information.

- Details about the VAV terminal unit including the configuration for fans and reheat.
- An STE-8001W36 or STE-8201W36 to use as a configuration tool.
- The building automation system plans for controllers connected to a network.

Users may change the active heating and cooling set points without accessing the configuration functions. This procedure is covered in the topic Changing the Room Set Point on page 13.

Note: *The instructions for the configuration functions cover all of the functions that an STE-8000 sensor can set up in the EZvav series of controllers. Not all functions are available on every model of controller.*

Configuration topics





Getting started with configuration	14
Entering system temperature set points and limits.....	15
Configuring the VAV Terminal Unit options	17
Set the airflow set points.....	19
Advanced options	21
Restore Application.....	23

Getting Started with Configuration

For access to the configuration functions you will need Password 2 .

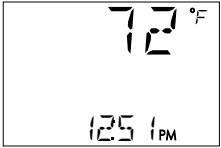
- If the controller has not been previously set up, no password is required.
- A new Password 2 can be entered or changed in the advance functions. See the topic Advanced options on page 21

Enter the configuration mode

PROCEDURE	STEPS	STE DISPLAY
1 Starting display	<ol style="list-style-type: none"> 1. Start at the temperature display. 2. Press the Δ and ∇ buttons together. <ul style="list-style-type: none"> • If Password 2 is not required, the display changes to ENFG. • If required, enter Password 2. The display changes to ENFG when Password 2 is correct. 	
2 Enter Password 2	<ol style="list-style-type: none"> 1. Press the Δ and ∇ buttons together and hold them down until the display changes to PSW2. 2. Press the Δ or ∇ button to change the first digit. 3. Press the  button to select the next digit. Repeat for all four digits. 4. When the button is pushed for the fourth correct digit, the display changes to ENFG. <p>Note: <i>If Password 2 has not previously been entered the display will change to the ENFG display after Step 1.</i></p>	
3 Select a configuration function.	Access to the configuration functions always start at the ENFG display.	

Entering System Temperature Set Points and Limits

The system temperature set points set the operational parameters and limits for the VAV terminal unit.







The temperature set points include the following items.

- Minimum cooling and maximum heating set points
- Occupied and unoccupied cooling set points
- Occupied and unoccupied heating set points
- Changeover differential set point
- Standby differential set point

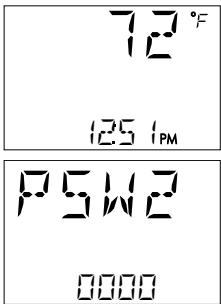

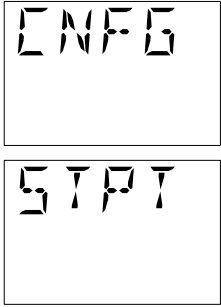



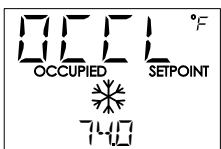

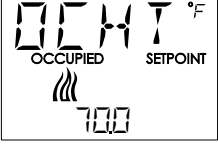

Setting the temperature set points requires entering Password 2 which is described in detail in the topic Getting started with configuration on page 14.

Tip: *Once the following procedure is started, all steps must be completed in order.*



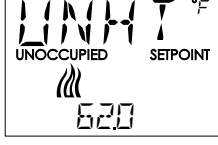

Procedure to set the temperature set points

PROCEDURE	STEPS	STE DISPLAY
1 Start at the temperature display.	<ol style="list-style-type: none"> 1. Start at the temperature display. 2. Press the Δ and ∇ buttons together. <ul style="list-style-type: none"> • If Password 2 is not required, the display changes to ENFG. • If required, enter Password 2. The display changes to ENFG when Password 2 is correct. 	
2 Set the minimum cooling set point.	<ol style="list-style-type: none"> 1. From the ENFG display, press the Δ or ∇ buttons to show STPT. 2. Press the  button to select the ENFG options. The display changes to STPT. 3. Press the  button to select STPT. The display changes to MIN. 	
3 Set the maximum heating set point.	<p>This set point limits the highest temperature a user can enter as the active set point.</p> <ol style="list-style-type: none"> 1. Press the Δ or ∇ buttons to set the maximum heating set point. The set point will change in 0.5° increments. 2. Press the  button to save the set point and advance to the next function. 	
4 Set the occupied cooling set point.	<p>This set point is used as the active set point when the space is occupied.</p> <ol style="list-style-type: none"> 1. Press the Δ or ∇ buttons to set the occupied cooling set point. The set point will change in 0.5° increments. 2. Press the  button to save the set point and advance to the next function. 	

Procedure to set the temperature set points (continue)

PROCEDURE	STEPS	STE DISPLAY
<p>5 Set the occupied cooling set point.</p>	<p>This set point is used as the active set point when the space is occupied.</p> <ol style="list-style-type: none"> 1. Press the Δ or ∇ buttons to set the occupied cooling set point. The set point will change in 0.5° increments. 2. Press the  button to save the set point and advance to the next function. <p>Note: This set point can also be changed as described in the topic Changing the room set point on page 13.</p>	
<p>6 Set the occupied heating set point.</p>	<p>This set point is used as the active set point when the space is occupied.</p> <ol style="list-style-type: none"> 1. Press the Δ or ∇ buttons to set the occupied heating set point. The set point will change in 0.5° increments. 2. Press the  button to save the set point and advance to the next function. <p>Note: This set point can also be changed as described in the section Changing the room set point on page 13.</p>	
<p>7 Set the unoccupied cooling set point.</p>	<p>This set point is used as the active set point when the space is unoccupied.</p> <ol style="list-style-type: none"> 1. Press the Δ or ∇ buttons to set the unoccupied cooling set point. The set point will change in 0.5° increments. 2. Press the  button to save the set point and advance to the next function. 	
<p>8 Set the unoccupied heating set point.</p>	<p>This set point is used as the active set point when the space is unoccupied.</p> <ol style="list-style-type: none"> 1. Press the Δ or ∇ buttons to set the unoccupied heating set point. The set point will change in 0.5° increments. 2. Press the  button to save the set point and advance to the next function. 	
<p>9 Set the supply air temperature changeover set point.</p> <p>Not used in all models.</p>	<p>This set point sets the supply air temperature at which the controller will change between heating to cooling.</p> <ol style="list-style-type: none"> 1. Press the Δ or ∇ buttons to set the changeover set point. The set point will change in 1° increments. 2. Press the  button to save the set point and advance to the next function. 	
<p>10 Set the minimum temperature differential set point.</p>	<p>The minimum allowable temperature value between the cooling and heating set points.</p> <ol style="list-style-type: none"> 1. Press the Δ or ∇ buttons to set the differential set point. The set point will change in 1° increments. 2. Press the  button to save the set point and advance to the next function. 	

Procedure to set the temperature set points (continue)

PROCEDURE	STEPS	STE DISPLAY
11 Set the standby differential set point.	<p>The standby set point is calculated by adding or subtracting the offset value to or from the value of the occupied set point.</p> <ol style="list-style-type: none"> Press the Δ or ∇ buttons to set the standby differential set point. The set point will change in 1° increments. Press the  button to save the set point and advance to the next function. 	
12 Select a new configuration function or exit.	<ol style="list-style-type: none"> Press the Δ or ∇ buttons to select one of the following: <ul style="list-style-type: none"> BOX, FLOW, RIVE, or RSTR options BACK to choose another configuration function. EXIT to return to the temperature display. Press the  button to select the next function. 	

Configuring the VAV Terminal Unit Options

The unit options set the controller for the specific mechanical installation of the VAV terminal unit. The unit options include the following items.

- The K-factor for the VAV terminal unit. If the K-factor is not available, see the topic K-factors on page 47.
- Reheat configuration (optional)
- Fan configuration (optional)
- Direction of damper to close







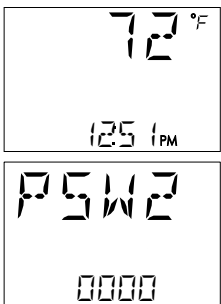

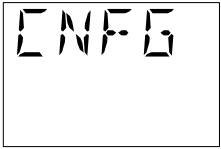
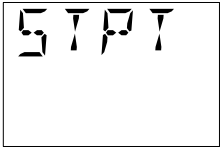
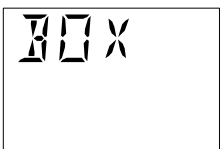

Setting the unit options requires entering Password 2 which is described in the topic Getting started with configuration on page 14.

Tip: *Once the following procedure is started, all steps must be completed in order.*

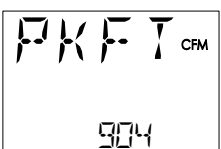

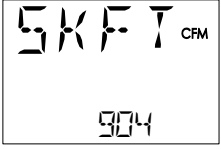
Procedure to set the Terminal Unit functions

PROCEDURE	STEPS	STE DISPLAY
1 Starting display	<ol style="list-style-type: none"> Start at the temperature display. Press the Δ and ∇ buttons together. <ul style="list-style-type: none"> If Password 2 is not required, the display changes to ENFG. If required, enter Password 2. The display changes to ENFG when Password 2 is correct. 	

Procedure to set the Terminal Unit functions (continue)

PROCEDURE	STEPS	STE DISPLAY
<p>2 Select the box settings display.</p>	<ol style="list-style-type: none"> From the CNF6 display, press the Δ or ∇ buttons to show the BOX display. Press the  button to select the CNF6 options. The display changes to STPT. Press the Δ or ∇ buttons to change the display to BOX. Press the  button to select BOX. 	  
<p>3 Set the primary VAV terminal unit K factor.</p>	<p>Refer to the K-factor label on the controls enclosure door of the terminal unit for appropriate value. You can also refer to page 43, visit www.nailor.com or contact your local Nailor Representative for more details.</p> <ol style="list-style-type: none"> Press the Δ or ∇ buttons to set the primary K-factor. Press the  button to save the entry and advance to the next function. 	
<p>4 Set the secondary VAV terminal unit K factor.</p> <p><i>Not used in all models.</i></p>	<ol style="list-style-type: none"> Press the Δ or ∇ buttons to set the secondary K-factor. Press the  button to save the entry and advance to the next function. 	
<p>5 Set the mode of reheat for the terminal unit.</p> <p><i>Not used in all models.</i></p>	<ol style="list-style-type: none"> Press the Δ or ∇ buttons to choose one of the following reheat options. None—Reheat is not enabled. Staged—Enables staged reheat. Modulating—The analog reheat output varies from 0—10 volts DC. Floating—The reheat outputs control a tristate actuator. Press the  button to save the reheat option and advance to the next function. 	
<p>6 Set the fan option.</p> <p><i>Not used in all models.</i></p>	<ol style="list-style-type: none"> Press the Δ or ∇ buttons to choose one of the following fan options. None—No fan is connected to the controller. <ul style="list-style-type: none"> Models: 3001, 30RE and 30RW, 3600 Series—The VAV unit includes a series fan. <ul style="list-style-type: none"> Model Series: 35S(ST), 35SE(ST), 35SW(ST), 37S(ST), 37SE(ST) and 37SW(ST), 38S/SE/SW Parallel—The VAV unit includes a parallel fan. <ul style="list-style-type: none"> Models: 35N, 37N, 35NE, 35NW, 37NE and 37NW Press the  button to save the fan option and advance to the next function. 	

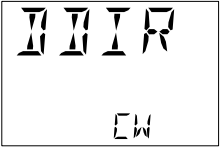
Procedure to set the Terminal Unit functions (continue)

PROCEDURE	STEPS	STE DISPLAY
7 Set the damper direction to close.	<ol style="list-style-type: none"> Press the Δ or ∇ buttons to which direction to damper moves to close. CCW—The actuator turns counterclockwise to close the damper. CW—The actuator turns clockwise to close the damper. (Default) Press the  button to save the damper option and advance to the next function. 	
8 Select a new configuration function or exit.	<ol style="list-style-type: none"> Press the Δ or ∇ buttons to select one of the following: <ul style="list-style-type: none"> STPT, FLOW, RIVE or RSTR options BACK to choose another configuration function. EXIT to return to the temperature display. Press the  button to select the next function. 	

Set the Airflow Set Points

The airflow set points set the airflow limits for the VAV terminal unit.



- Airflow heating and cooling minimum and maximum limits
- Auxiliary flow set point (optional)
- Minimum and maximum fan speeds (optional)

Setting the airflow set points requires entering Password 2 which is described in the topic Getting started with configuration on page 14.





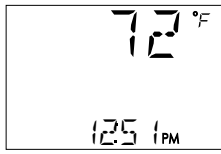











Note: *If the VAV unit is a heat only or cooling only unit, the airflow set points for the unused mode must be set within the range of the mode in use. Failure to set the unused set points correctly will result in unpredictable or erroneous air balancing settings.*

Tip: *Once the following procedure is started, all steps must be completed in order.*





Procedure to set the airflow set points

PROCEDURE	STEPS	STE DISPLAY
1 Starting display	<ol style="list-style-type: none"> Start at the temperature display. Press the Δ and ∇ buttons together. <ul style="list-style-type: none"> • If Password 2 is not required, the display changes to ENFG. • If required, enter Password 2. The display changes to ENFG when Password 2 is correct. 	 

Procedure to set the airflow set points (continue)

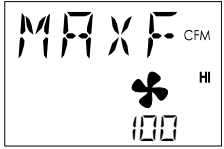
PROCEDURE	STEPS	STE DISPLAY
<p>2 Select the set point settings display.</p>	<ol style="list-style-type: none"> From the C N F G display, press the Δ or ∇ buttons to show the C N F G display. Press the  button to select the C N F G options. The display changes to S T P T. Press the Δ or ∇ buttons to change the display to F L O W. Press the  button to select F L O W. The display changes to M N E L. 	  
<p>3 Set the cooling minimum airflow limit.</p>	<ol style="list-style-type: none"> Press the Δ or ∇ buttons to set the minimum limit for cooling airflow. The set point changes in 1 CFM increments. Press the  button to save the set point and advance to the next function. 	
<p>4 Set the cooling maximum airflow limit.</p>	<ol style="list-style-type: none"> Press the Δ or ∇ buttons to set the maximum limit for cooling airflow. The set point changes in 1 CFM increments. Press the  button to save the set point and advance to the next function. 	
<p>5 Set the auxiliary airflow set point.</p> <p><i>Not used in all models.</i></p> <p>Tip: Set value to match Min. Cooling airflow if not required.</p>	<p>This set point sets the airflow for when reheat is active.</p> <ol style="list-style-type: none"> Press the Δ or ∇ buttons to set a value for the auxiliary airflow. The set point changes in 1 CFM increments. Press the  button to save the set point and advance to the next function. 	
<p>6 Set the heating minimum airflow limit.</p>	<ol style="list-style-type: none"> Press the Δ or ∇ buttons to set the minimum limit for heating airflow. The set point will change in 1 CFM increments. Press the  button to save the set point and advance to the next function. 	
<p>7 Set the heating maximum airflow limit.</p>	<ol style="list-style-type: none"> Press the Δ or ∇ buttons to set the maximum limit for heating airflow. The set point will change in 1 CFM increments. Press the  button to save the set point and advance to the next function. 	
<p>8 Set the minimum limit for fan speed.</p> <p><i>Not used in all models.</i></p>	<ol style="list-style-type: none"> Press the Δ or ∇ buttons to set the minimum limit for the fan speed. The set point will change in 1% increments. Press the  button to save the set point and advance to the next function. 	

Procedure to set the airflow set points (continue)

PROCEDURE	STEPS	STE DISPLAY
<p>9 Set the maximum limit for fan speed.</p> <p><i>Not used for all models.</i></p>	<ol style="list-style-type: none"> 1. Press the Δ or ∇ buttons to set the maximum limit for the fan speed. The set point will change in 1% increments. 2. Press the  button to save the set point and advance to the next function. 	
<p>10 Set the dual duct minimum airflow.</p> <p><i>Not used for all models.</i></p>	<ol style="list-style-type: none"> 1. This set point is for the minimum airflow when a Dual duct system is at temperature set point. 1. Press the Δ or ∇ buttons. 2. Press the  button to save the set point and advance to the next function. 	
<p>11 Select a new configuration function or exit.</p>	<ol style="list-style-type: none"> 1. Press the Δ or ∇ buttons to select one of the following: <ul style="list-style-type: none"> • STPT, BOX, AIVE, or RSTR options • BACK to choose another configuration function EXIT. 2. Press the  button to select the next function. 	

Advanced Options

The advanced options set up passwords and special features in the controller.

- Establish or change Password 1 and Password 2
- Set timers for standby and override (optional)
- Enable automatic occupancy (optional)
- Enable discharge air temperature control (optional)
- Calibrate the sensor







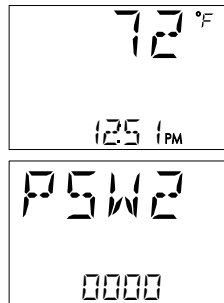



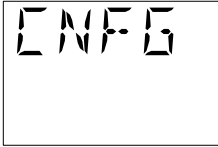

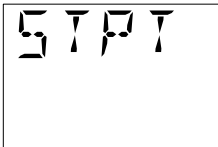





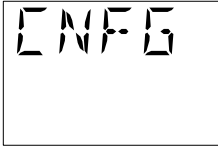
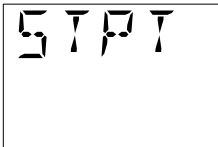











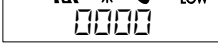

Setting the advance options requires entering Password 2 which is described in the topic Getting started with configuration on page 14.

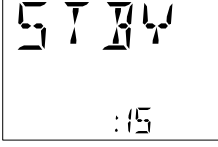
Tip: *Once the following procedure is started, all steps must be completed in order.*



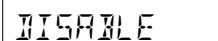

Procedure to set the advanced options

PROCEDURE	STEPS	STE DISPLAY
<p>1 Starting display</p>	<ol style="list-style-type: none"> 1. Start at the temperature display. 2. Press the Δ and ∇ buttons together. <ul style="list-style-type: none"> • If Password 2 is not required, the display changes to ENFB. • If required, enter Password 2. The display changes to ENFB when Password 2 is correct. 	

Procedure to set the advanced options (continue)

PROCEDURE	STEPS	STE DISPLAY
<p>2 Select the advanced display.</p>	<p>1. From the  display, press the  buttons to show the  display.</p> <p>2. Press the  or  buttons to change the display to .</p> <p>3. Press the  button to select .</p>	  
<p>3 Change Password 1.</p>	<p>Note: Entering four zeros (0000) removes the password.</p> <p>1. Press the  or  buttons to change the first digit.</p> <p>2. Press the  button to select the next digit. Repeat for all four digits.</p> <p>3. When the  button is pressed for the last digit, the new password is saved and the display advances.</p>	 
<p>4 Change Password 2.</p>	<p>Note: Entering four zeros (0000) removes the password.</p> <p>1. Press the  or  buttons to change the first digit.</p> <p>2. Press the  button to select the next digit. Repeat for all four digits.</p> <p>3. When the  button is pressed for the last digit, the new password is saved and the display advances.</p>	 
<p>5 Set the standby time <i>Applies only to STE-8201 sensors.</i></p>	<p>1. Press the  or  buttons to set the time for the standby time. The value will change in 1 minute increments.</p> <p>2. Press the  button to save the set point and advance to the next function.</p>	
<p>6 Set the DAT Limiting mode. <i>Do not enable for staged heating as short cycling may occur.</i></p>	<p>1. Press the  or  buttons to enable or disable discharge air temperature limiting.</p> <p>2. Press the  button to save the set point and advance to the next function.</p>	
<p>7 Set the automatic occupancy mode. <i>Not used for all models. Required for reheat.</i></p>	<p>1. Press the  or  buttons to enable or disable discharge air temperature limiting.</p> <p>2. Press the  button to save the set point and advance to the next function.</p> <p>Enable The controller will automatically changed to the unoccupied state when it detects the loss of primary air supply.</p> <p>Disable The controller will remain in the occupied mode regardless of the primary air supply.</p>	 

Procedure to set the advanced options (continue)

PROCEDURE	STEPS	STE DISPLAY
8 Set the temperature sensor calibration constant.	<ol style="list-style-type: none"> Press the Δ or ∇ buttons to set the calibration constant. The set point will change in 0.1 minute increments. <ul style="list-style-type: none"> For a low input reading enter a positive correction value. For a high input reading enter a negative correction value. Press the  button to save the set point and advance to the next function. 	
9 Select a new configuration function or exit.	<ol style="list-style-type: none"> Press the Δ or ∇ buttons to select one of the following: <ul style="list-style-type: none"> STPT, FLOW, BOX, or RSTR options BACK to choose .another configuration function EXIT to return to the temperature display. Press the  button to select the next function. 	

Restore Application

Choose the RSTR function to reset the EZvav controller to the original configuration and settings. Use it also to change the units of measure to display on a EZvav sensor. There are two versions of the application program in the controller.

- The Metric version displays temperature in Celsius and uses metric values for units of measure.
- The English version displays temperature in Fahrenheit and uses English values for units of measure.

Access to the Restore Application function requires entering Password 2 which is described in the topic Getting started with configuration on page 14.

Tip: *Once the following procedure is started, all steps must be completed in order.*







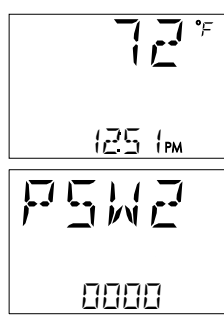

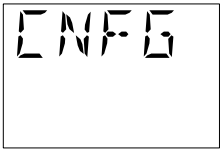
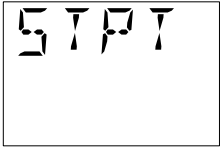
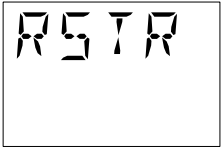

CAUTION *Choosing RSTR deletes all previously configured values including balancing values and passwords. Only the BACnet communications settings will remain unchanged.*

Procedure to restore application

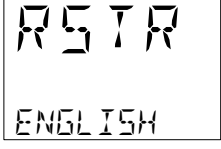
PROCEDURE	STEPS	STE DISPLAY
1 Starting display	<ol style="list-style-type: none"> Start at the temperature display. Press the Δ and ∇ buttons together. <ul style="list-style-type: none"> If Password 2 is not required, the display changes to ENFG. If required, enter Password 2. The display changes to ENFG when Password 2 is correct. 	

Procedure to restore application (continue)

PROCEDURE	STEPS	STE DISPLAY
<p>2 Select the restore settings display.</p>	<ol style="list-style-type: none"> From the CNF G display, press the Δ or ∇ buttons to show the CNF G display. Press the  button to select the CNF G options. The display changes to S T P T. Press the Δ or ∇ buttons to change the display to R S T R. <p>Caution: Choosing R S T R deletes all previously entered values and returns the controller to the manufacturer's settings. Only the BACnet communications settings will remain unchanged.</p> <ol style="list-style-type: none"> Press the  button to select R S T R. 	  
<p>3 Choose the application.</p>	<ol style="list-style-type: none"> Press the Δ or ∇ buttons to choose ENGLISH or METRIC. <p>Metric The sensor displays temperature in Celsius and uses metric values for units of measure. English The sensor displays temperature in Fahrenheit and uses English values for units of measure.</p> <ol style="list-style-type: none"> Press the  button to save the entry and advance to the next function. 	   

Section 6: Balancing Airflow

Topics in this section are for control technicians or engineers who will be balancing the airflow in the controllers.

The airflow balancing procedure described in this section requires the following items.

- Accurate method to measure airflow.
- An STE-8001W36 or STE-8201W36 wall sensor. If the system does not include one of these sensors, temporarily disconnect the installed sensor and connect an STE-8001W36 as a service tool.
- The engineering design specifications for the minimum and maximum airflow set points.
- Password 2 which is described in the topic Getting started with configuration on page 14.





Users may change the active heating and cooling set points without accessing the configuration functions. This procedure is covered in the topic Changing the Room Set Point on page 13.

Note: *If the VAV terminal unit is a heat only or cooling only unit, the airflow set points for the unused mode must be set within the range of the mode in use. Failure to set the unused set points correctly will result in unpredictable or erroneous air balancing settings. See Set the airflow set points on page 19 for the procedure to adjust the set points.*



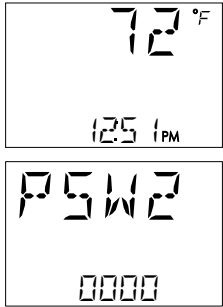

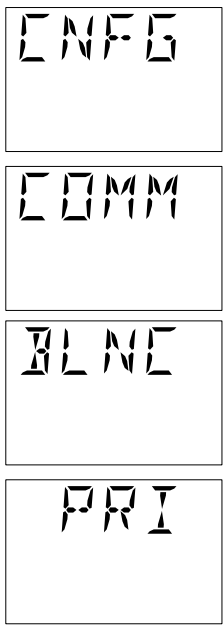

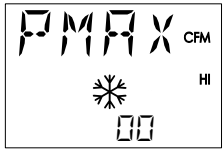





Note: *Starting the balancing procedure erases all previous airflow correction factors. The airflow readings displayed by the STE-8001W36 are the actual uncorrected airflow readings as measured by the controller.*

Tip: *Once the following procedure is started, all steps must be completed in order.*

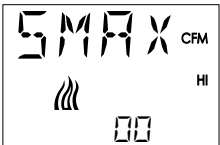

The airflow balancing procedure

PROCEDURE	STEPS	STE DISPLAY
<p>1 Starting display.</p>	<ol style="list-style-type: none"> 1. Start at the temperature display. 2. Press the Δ and ∇ buttons together. <ul style="list-style-type: none"> • If Password 2 is not required, the display changes to CNFG. • If required, enter Password 2. The display changes to CNFG when Password 2 is correct. 	
<p>2 Select the CNFG display.</p>	<ol style="list-style-type: none"> 1. From the CNFG display, press the Δ or ∇ buttons to advance to COMM and the BLNC display. 2. Press the  button to select BLNC. The display advances to PRI. 3. Press the  button to select PRI. 	
<p>3 Measure and enter the actual maximum primary airflow.</p>	<p>The display begins flashing PMAX and also displays the actual airflow at the bottom.</p> <p>Note: The airflow will attempt to stabilize on the highest value for either the cooling or heating maximum airflow even if only one mode is operational.</p> <p>Note: The airflow displayed by the STE-8000 in this step is the actual, uncorrected airflow.</p> <ol style="list-style-type: none"> 1. Wait for the maximum airflow value to stabilize. 2. With a flow hood, measure the actual airflow. 3. Press the  button to advance to the entry display. PMAX stops flashing. 4. Press the Δ or ∇ buttons to enter the measured airflow. 5. Press the  button to save the measured airflow. The display changes to PMIN. 	

The airflow balancing procedure (continue)

PROCEDURE	STEPS	STE DISPLAY
<p>4 Measure and enter the actual minimum primary airflow.</p>	<p>The display begins flashing P M I N and also displays the actual airflow at the bottom.</p> <p>Note: The airflow will attempt to stabilize on the lowest value for either the cooling or heating minimum airflow even if only one mode is operational.</p> <p>Note: The airflow displayed by the STE-8000 in this step is the actual, uncorrected airflow.</p> <ol style="list-style-type: none"> 1. Wait for the minimum airflow value to stabilize. 2. With a flow hood, measure the actual airflow. 3. Press the  button to advance to the entry display. P M I N stops flashing. 4. Press the Δ or ∇ buttons to enter the measured airflow. 5. Press the  button to save the measured airflow. The display advances to P R I. 	
<p>5 Advance or exit.</p>	<ol style="list-style-type: none"> 1. Press the Δ or ∇ buttons to select one of the following: <ul style="list-style-type: none"> • S E C to balance the secondary VAV for dual duct systems. Choosing S E C advances to the S M A X display. This is available only on dual duct models. • A R E K to choose another commissioning function • E X I T to return to the temperature display. 2. Press the  button to select the next function. 	 
<p>6 Measure and enter the actual maximum secondary airflow.</p>	<p>The display begins flashing S M A X and also displays the actual airflow at the bottom.</p> <p>Note: The airflow displayed by the STE-8000 in this step is the actual, uncorrected airflow.</p> <ol style="list-style-type: none"> 1. Wait for the maximum airflow value to stabilize. 2. With a flow hood, measure the actual airflow. 3. Press the  button to advance to the entry display. S M A X stops flashing. 4. Press the Δ or ∇ buttons to enter the measured airflow. 5. Press the  button to save the measured airflow. The display advances to S M I N. 	
<p>7 Measure and enter the actual minimum secondary airflow.</p>	<p>The display begins flashing S M I N and also displays the actual airflow at the bottom.</p> <p>Note: The airflow displayed by the STE-8000 in this step is the actual, uncorrected airflow.</p> <ol style="list-style-type: none"> 1. Wait for the minimum airflow value to stabilize. 2. With a flow hood, measure the actual airflow. 3. Press the  button to advance to the entry display. S M I N stops flashing. 4. Press the Δ or ∇ buttons to enter the measured airflow. 5. Press the  button to save the measured airflow. The display advances to S E C. 	

The airflow balancing procedure (continue)

PROCEDURE	STEPS	STE DISPLAY
<p>8 Advance or exit.</p>	<p>1. Press the Δ or ∇ buttons to select one of the following:</p> <ul style="list-style-type: none"> • <i>PRI</i> to balance the primary VAV for dual duct systems • <i>BACK</i> to choose another configuration function. • <i>EXIT</i> to return to the temperature display. <p>2. Press the  button to select the next function.</p>	

Quick Start Configuration Guide – EZvav Sensors & Controllers

Use an STE-8001W36 or STE-8201W36 sensor to configure the EZvav controller. If another type of sensor is installed as the room sensor, temporarily connect an STE-8001W36 as a service tool.

To get started:

Press together the up Δ and down ∇ buttons to start configuration or balancing.

Enter Password 2 if required. New installations do not have a password.

Press the up Δ or down ∇ buttons to move between functions or change values.

Press the set point button to choose a selection or save a value.

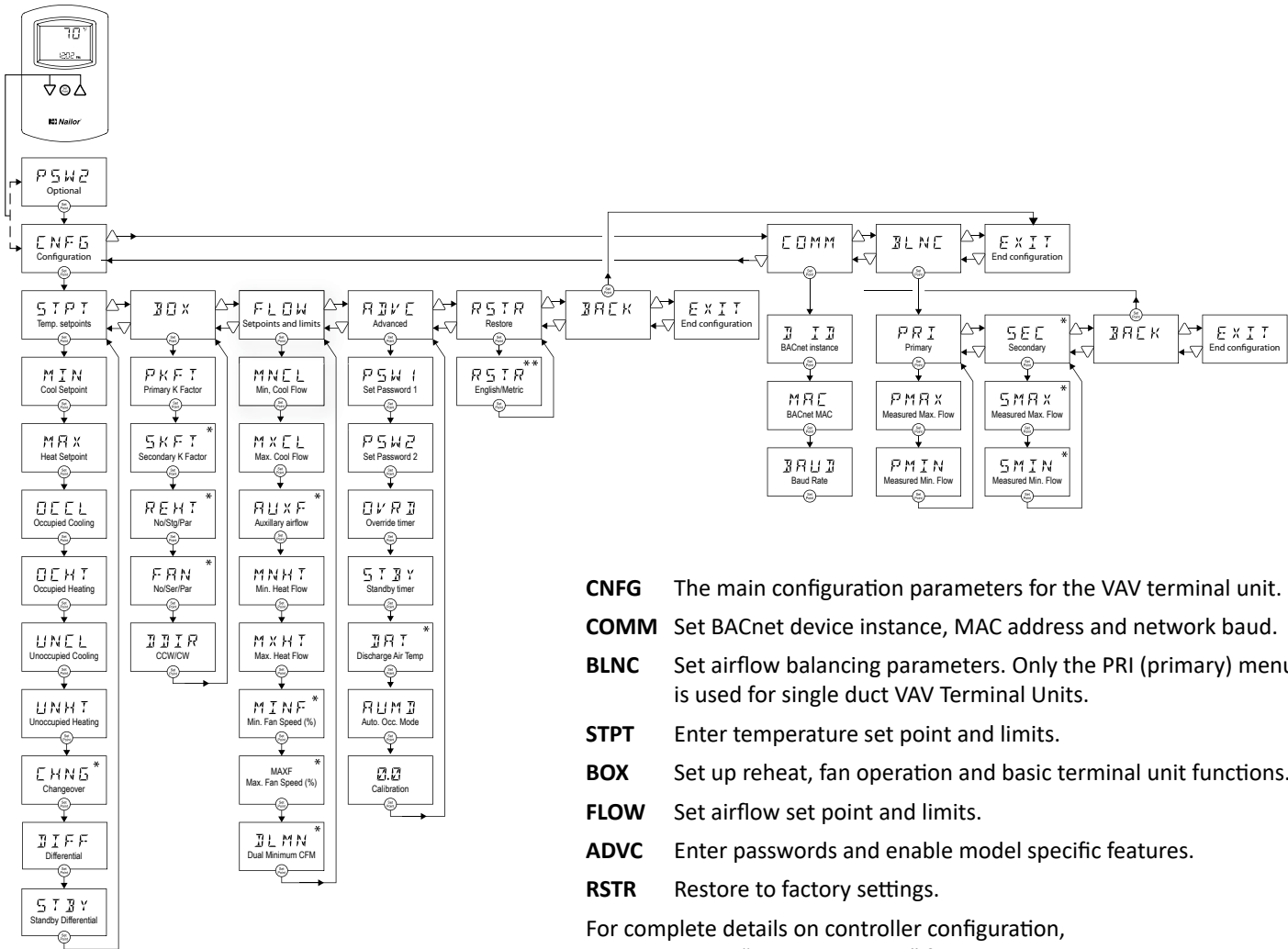

- CNFG** The main configuration parameters for the VAV terminal unit.
- COMM** Set BACnet device instance, MAC address and network baud.
- BLNC** Set airflow balancing parameters. Only the PRI (primary) menu is used for single duct VAV Terminal Units.
- STPT** Enter temperature set point and limits.
- BOX** Set up reheat, fan operation and basic terminal unit functions.
- FLOW** Set airflow set point and limits.
- ADVC** Enter passwords and enable model specific features.
- RSTR** Restore to factory settings.

For complete details on controller configuration, download IOM "IOM-EZVAVINST" from Nailor website.

** Not used for all models*

*** Select English (factory setting) or Metric before setting other parameters.*

Section 7: Application Drawings

This section covers the drawings, materials, and instructions for specific VAV applications.

Each EZvav model is designed for a specific set of applications. The following topics are for control technicians and engineers that will plan for and install controllers for EZvav applications.

Submittal sheets for all of these applications are available from the Resources page at www.nailor.com.

Cooling or heating without reheat.....	29
Staged reheat.....	30
Modulating reheat.....	31
Floating reheat.....	32
Dual duct application.....	33

Cooling or Heating without Reheat

The BAC-8001-36 is configured for single duct cooling VAV control without reheat. Connect the controller as shown in the Figure Cooling or heating application drawing as below. A BAC-8005-36 may also be used for this application.

For cooling and heating, a duct temperature sensor is required for Discharge Air Temperature limiting and automatic changeover. See the topic Advanced options on page 21 for instructions to enable Discharge Air Temperature limiting.

Submittal sheets for several variations of this application are available from the Resources page at www.nailor.com.

Figure 7-1 Cooling or heating application drawing

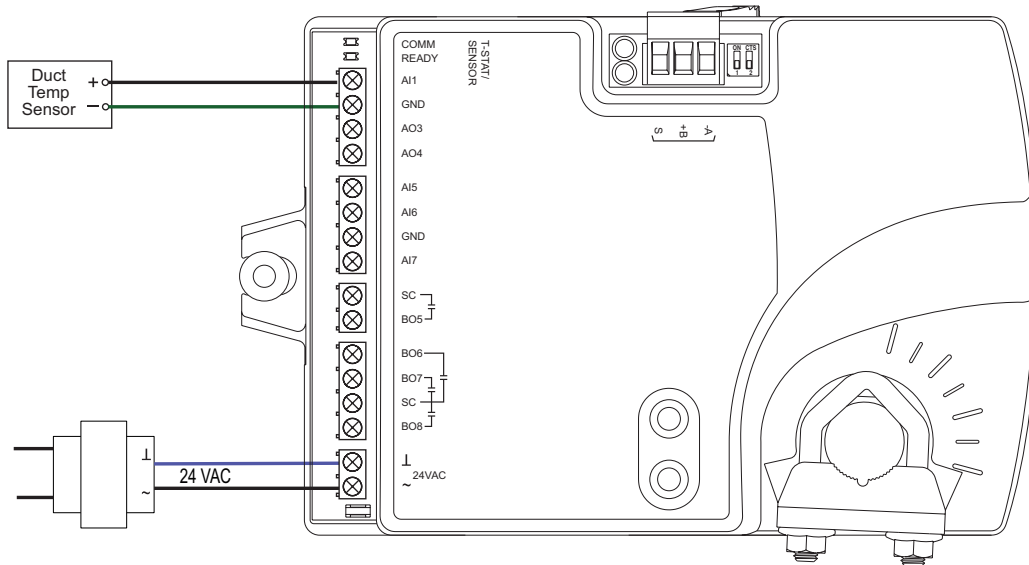

Staged Reheat

This application is for BAC 8005-36 controller. The controller are configured to switch reheat units that are controlled with 24 volts AC. Reheat units with up to three stages of reheat can be controlled by these controllers.

- For one-stage or electric reheat or hot water reheat with an on/off valve, use only output terminal BO6.
- For two-stage reheat use output terminals BO6 and BO7.
- For three-stage reheat use output terminals BO6, BO7 and BO8.

For cooling and heating, a duct temperature sensor is required for automatic changeover.

When connecting the controller to a fan powered VAV terminal unit, the fan circuits must be compatible with the following specifications.

- The fan start circuit is a 24 volt AC pilot duty output.
- The fan speed output is 0 – 10 volts DC.

Submittal sheets for several variations of this application are available from the Resources page at www.nailor.com.

Figure 7-2 BAC-8005-36 (Single Duct) with three-stage reheat

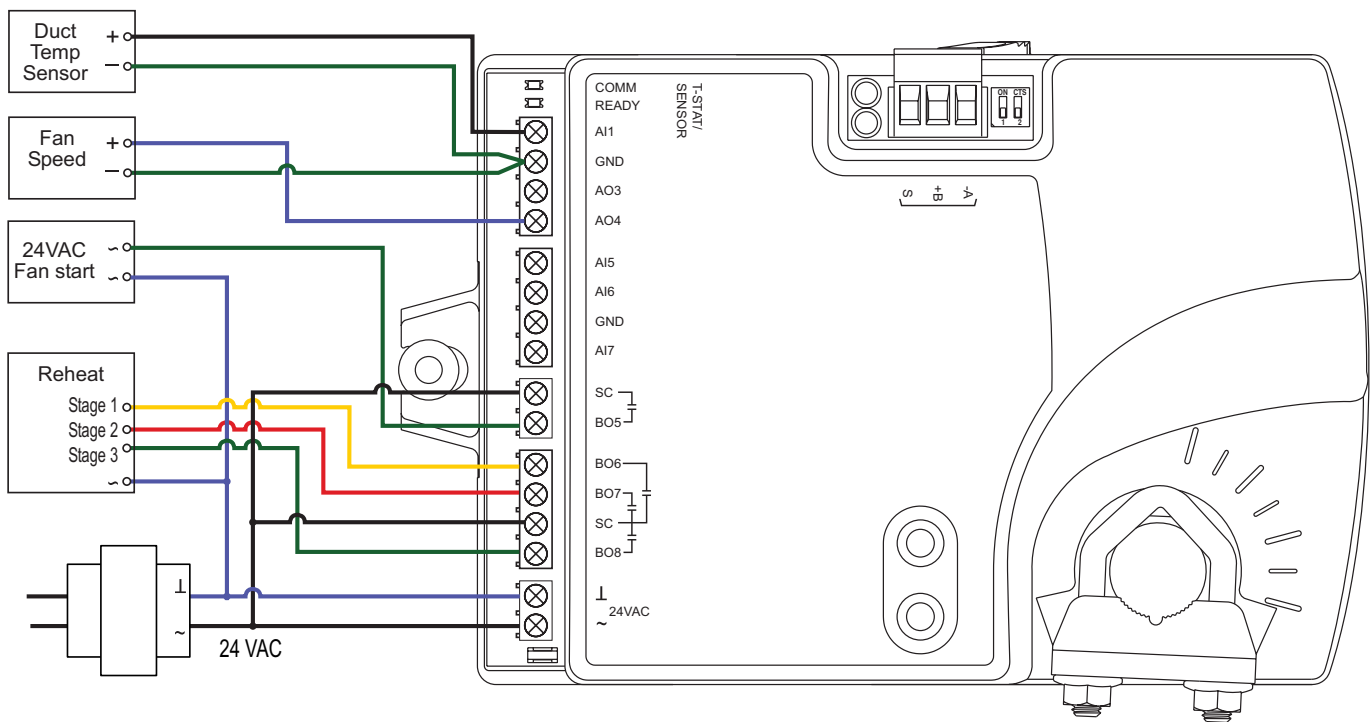

Modulating Reheat

This application is for a BAC-8005-36 controller. The modulating option for reheat can control either an electric reheat unit with an analog input or a modulating hot water valve. The analog reheat output at output terminal AO3 varies between 0 and 10 volts DC.

For cooling and heating, a duct temperature sensor is required for Discharge Air Temperature limiting and automatic changeover. See the topic Advanced options on page 21 for instructions to enable Discharge Air Temperature limiting.

When connecting the controller to a fan powered VAV terminal unit, the fan circuits must be compatible with the following specifications.

- The fan start circuit is a 24 volt AC pilot duty output.
- The fan speed output is 0 – 10 volts DC.

Submittal sheets for several variations of this application are available from the Resources page at www.nailor.com.

Figure 7-3 Modulating reheat

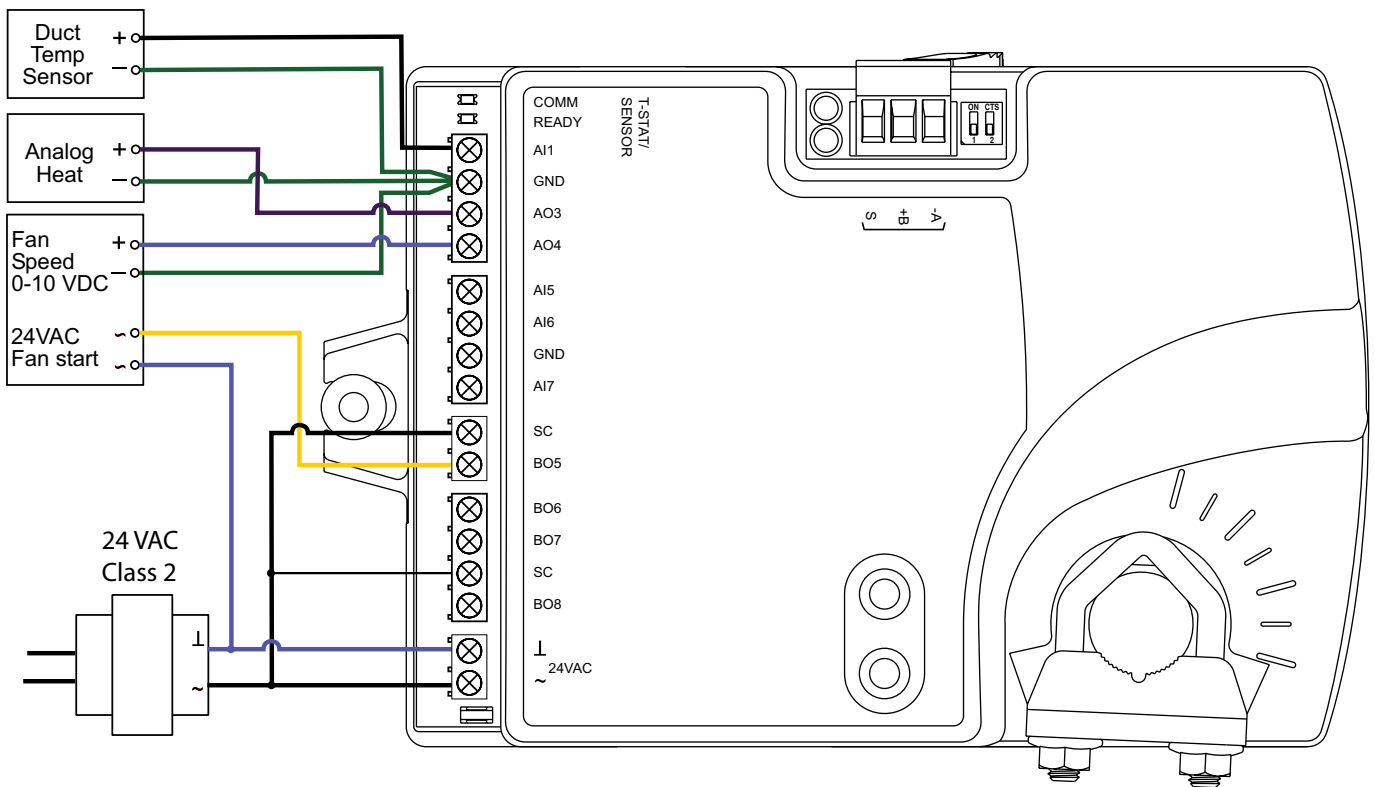

Floating Reheat

This application is for a BAC-8005-36 controller. Use the floating reheat option in hydronic systems that are controlled by an actuator with tri-state inputs. The reheat outputs are triacs that can switch up to 1 ampere at 24 volts AC.

For cooling and heating, a duct temperature sensor is required for Discharge Air Temperature limiting and automatic changeover. See the topic Advanced options on page 21 for instructions to enable Discharge Air Temperature limiting.

When connecting the controller to a fan powered VAV unit, the fan circuits must be compatible with the following specifications.

- The fan start circuit is a 24 volt AC pilot duty output.
- The fan speed output is 0 – 10 volts DC.

Submittal sheets for several variations of this application are available from the Resources page at www.nailor.com.

Figure 7-4 Floating reheat

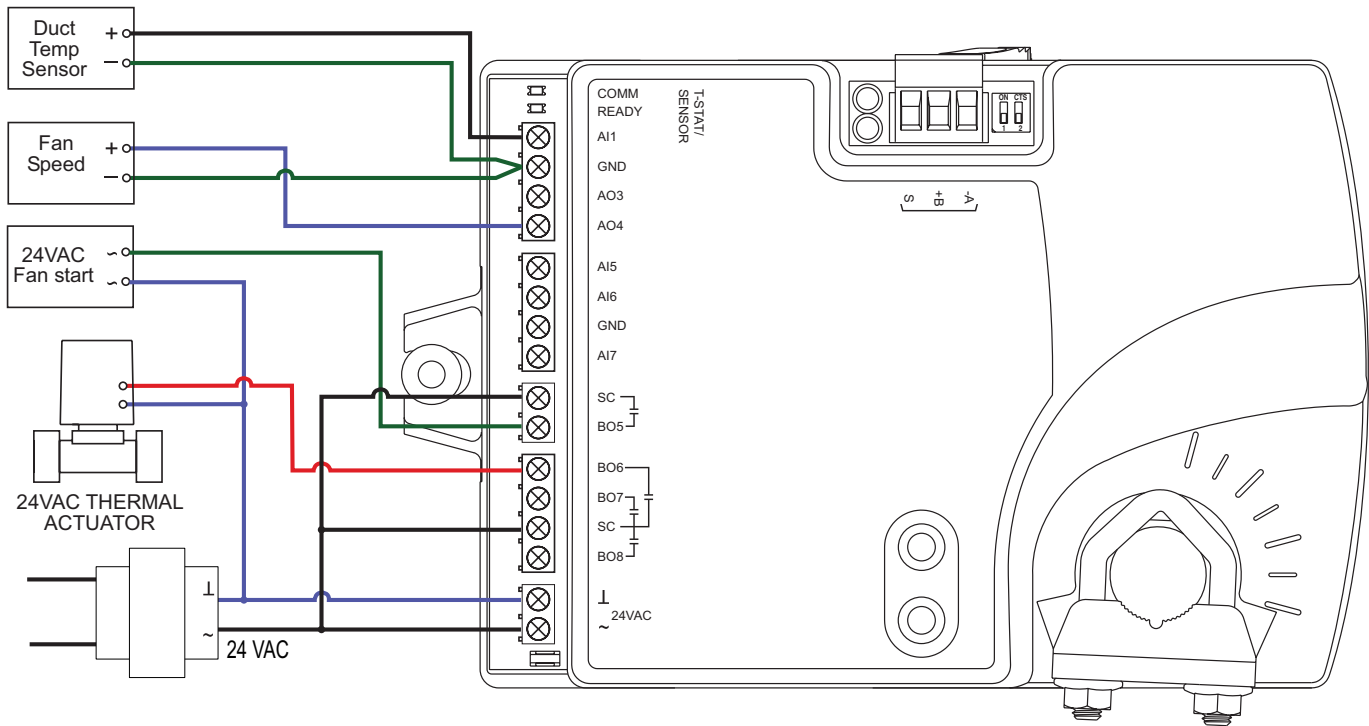

Dual Duct Application

This application is for a BAC-8007-36 controller. The controller is configured for Dual duct operation. Dual duct VAV requires a TSP-8001-36 actuator to be used with the BAC-8007-36 as shown in the Figure 7-5 Dual duct wiring diagram on page 33.

Submittal sheets for several variations of this application are available from the Knowledge Center page at www.nailor.com.

Dual duct wiring diagram

Figure 7-5 Dual duct wiring diagram

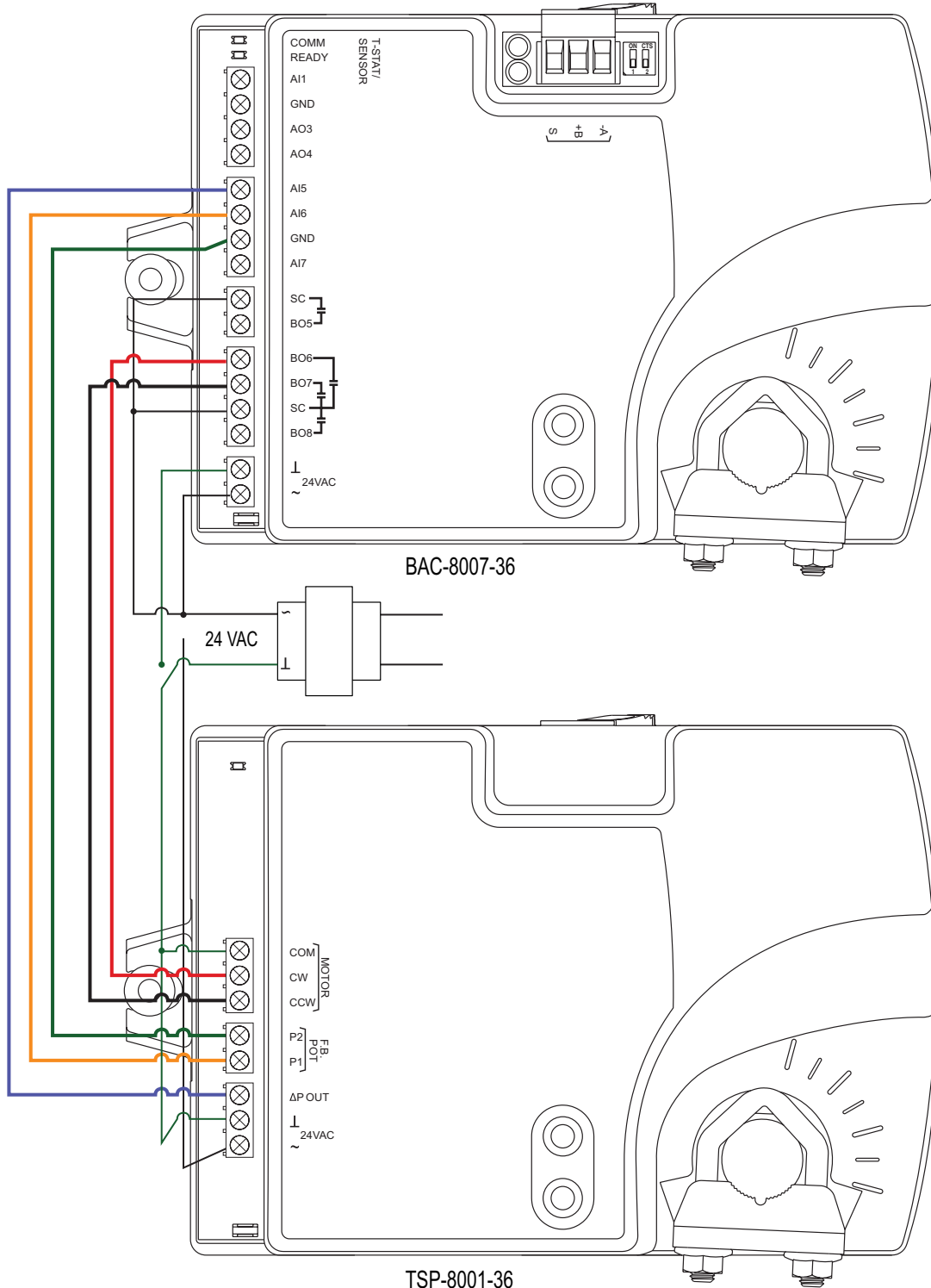

Section 8: Sequence of Operation

Topics in this section cover the sequences of operation for the EZvav controllers. These are advanced topics for control technicians and engineers.

These sequences of operation are descriptions of each major component of the EZvav programming. They are provided as an aid to understanding how the controllers operate.

This section covers the following sequences of operation.

Input sources	34
Occupancy sequence	35
Space set points	35
PID control loops	36
Airflow set points sequence	36
Changeover	36
Discharge Air Temperature (DAT) limiting	37
System diagnostics	37
Damper operation	38
Fan operation	38
Reheat sequence	39
Balancing airflow sequence	40
Dual duct	40

Input sources

The EZvav controllers require specific sensors to measure room temperature, airflow, and discharge air temperature. All sensors are automatically detected and the programming is automatically set up for the sensors.

- EZvav digital wall sensors.
- STE-6014W36 thermistor temperature sensor.
- Discharge air temperature sensor.
- Diamond Flow sensor.

EZvav digital wall sensors — The EZvav digital wall sensors include a room temperature sensor, a digital display, and a push button interface for entering set points and configuring the controllers. If a EZvav digital wall sensor is detected, the sensor’s temperature is mapped to the Space Temperature Reference value object as the temperature input value. See the topic BACnet objects on page 44 for additional information on value objects.

The model STE-8201W36 EZvav digital wall sensor also includes a motion sensor to detect when the zone is temporary occupied. This is described in the topic Occupancy sequence on page 35.

STE-6014W36 thermistor temperature sensor — STE-6014W36 sensor is compatible with the EZvav controllers. If the sensor is detected, the sensor temperature is mapped to the Space Temperature Reference value object as the temperature input value. See the topic BACnet objects on page 44 for additional information on value objects.

Discharge air temperature sensor — The DAT sensor is an optional Type-III, 10 kΩ thermistor and is required for VAV heating applications. If the controller detects that this sensor is connected, then the controller will use discharge air temperature to determine when to change between heating and cooling. The DAT sensor input is used also to control reheat. See the topics Discharge Air Temperature (DAT) limiting on page 37 and Changeover on page 36.

Diamond Flow sensor — A multi-point airflow sensor that is designed to provide an averaged and accurate signal for use with pressure independent controls. Pick-ups are located in all four quadrants of the inlet. Through amplification of the velocity pressure signal (ΔP), the controller is capable of lower minimums by increasing sensitivity at lower airflows. The high and low pressure measurements along with the K-factor of the VAV terminal unit are used to calculate the airflow through the VAV unit.

Occupancy Sequence

An EZvav controller is designed to operate as a stand-alone controller and determine occupancy based only on the availability of primary airflow and motion in the zone. The controller can be in any one of the following occupancy states.

- Occupied
- Unoccupied
- Standby

Occupancy can also be commanded by another BACnet device or an operator workstation connected to the building automation network. See the topic System Integration and Networking on page 41 for details.

Automatic occupancy

If Automatic Occupancy is enabled, the controller will automatically toggle between Unoccupied, Occupied, and Standby based on the presence of primary airflow and motion in the zone.

The default for Automatic Occupancy is Disabled. See the topic Advanced options on page 21 to change Automatic Occupancy.

Occupied

For controllers without a connected motion sensor, the controller changes to Occupied upon the detection of primary airflow.

Controllers with a connected motion sensor change to Occupied upon the detection of primary airflow and motion in the space. The unit will remain in the Occupied state as long as periodic motion is detected and primary airflow continues. If motion stops, the controller changes to Standby.

Unoccupied

The controller Occupancy mode changes to Unoccupied when it detects a loss of primary airflow. While in the Unoccupied state, the controller will fully open the damper in an attempt to reach the maximum airflow set point.

Loss of primary airflow is defined as less than 25% of the requested flow for at least 5 minutes. The Occupancy mode changes to Occupied or Standby once the actual airflow is at least 30% of the requested flow.

Standby

In units with a connected motion sensor, the controller starts in Standby and changes to Occupied after detecting motion in the space. Motion in the space is defined as two movements detected within 5 minutes. The controller will change back to Standby after a lack of motion for the period specified by the variable Standby Time.

Standby mode is not valid for controllers without a motion sensor, unless commanded by a building management system.

Space Set Points

There are four temperature set points each for heating and cooling for a total of eight set points.

- **Active cooling**
- **Occupied cooling**
- **Unoccupied cooling**
- **Standby cooling**
- **Active heating**
- **Occupied heating**
- **Unoccupied heating**
- **Standby heating**

Types of set points

The EZvav controllers may use any of the following set points based on a user entered set point or the state of occupancy and standby which is described in the topic Occupancy sequence on page 35.

Active set point—The active set point is the current set point. The active set point is determined by the following.

- If the space is occupied, the controller uses the occupied set point as the active set point.
- If the space is unoccupied the controller uses the unoccupied set point as the active set point.
- If controller occupancy is Standby, the controller calculates the standby set point.
- A user with Password 1 can enter an active set point from a EZvav digital wall sensor. This entry will change the occupied set point within the set point limits.
- If a sensor with a dial set point is connect to the controller, the dial position is used for the active set point only when the Occupancy state is Occupied.

Occupied set point—A temperature set point entered by the controls technician during controller setup and system commissioning. This is the set point used when the controller is occupied which is determined by primary airflow and, on controllers equipped with motion sensors, motion in the zone.

Unoccupied set point — A temperature set point entered by the controls technician during controller setup and system commissioning. This is the set point used when the system is unoccupied .

Standby set point — The standby set point is used when the controller is in the standby state. It is a value calculated from the occupied set point and the value of Standby Offset. The standby offset value is entered by the controls technician during controller setup and system commissioning. See the topic Occupancy sequence on page 35.

Set Point Limits

The programming in the EZvav controller limits the set point entry so that no heating set point is set higher than its corresponding cooling set point.

If a user is adjusting a set point and it falls within the range set by the value of Minimum Set point Differential, the corresponding set point will be changed to maintain the differential. For example, the Minimum Set point Differential is 4° F (-15.56° C) and the Occupied Heating set point is 70° F (21.11° C). If the user lowers the Occupied Cooling set point to 71° F (21° C), the controller recalculates the Occupied Heating set point and changes it to 67° F (19.44° C).

PID Control Loops

A PID control loop calculates an error value from the difference between the measured room temperature and the active set point. The error value is expressed as a percentage and is typically used in a BAS controller to control the state of an output. When the difference between the set point and room temperature is large, the error is large. As the system reduces the difference between the set point and space temperature, the error becomes smaller.

The EZvav controllers use up to three PID loops.

- The heating PID loop.
- The cooling PID loop.
- The discharge air temperature (DAT) loop.

For EZvav controllers, the output of either the cooling and heating PID loop is used to calculate the position of the damper. If present, the DAT input and DAT loop controls the Reheat loop.

The PID loops in the EZvav controllers are standard BACnet objects and are described in the topic BACnet objects on page 44.

Airflow Set Points Sequence

Airflow Set point is calculated based on the demand for cooling or heating depending on whether the Cooling loop or Heating loop is greater than zero.

If no room sensor is connected to the controller, the controller uses the Minimum Cooling Airflow set point to maintain airflow.

Cool Air Sequence

As the Cooling loop increases from 0% to 100%, Primary Airflow Set point is proportionally calculated between Minimum Cooling Airflow and Maximum Cooling Airflow.

If there is a call for reheat to maintain room temperature, the primary airflow is set to the value of Auxiliary Flow.

Tip: Auxiliary Flow is only for unit with reheat. Set to Minimum Cooling Airflow unless alternate airflow is desired.

Warm Air Available

In the heating mode, as the Heating Loop increases from 0% to 100%, Primary Airflow Set point is proportionally calculated between Minimum Heating Airflow and Maximum Heating Airflow.

See also the topics, Changeover on page 36 and Input sources on page 34.

Changeover

The Discharge Air Temperature input is used by the controller to determine the type of air that is being supplied by the AHU. The sensor is required for applications that require automatic change over between cooling and heating.

When the Heating loop is inactive, the Discharge Air Temperature input is compared to the SAT Changeover Temp. If the Discharge Air Temperature is below the SAT Changeover Temp minus 2° Fahrenheit (-16.67 Celsius), the SAT Changeover Mode is set to Cool. If the Discharge Air Temperature is above the SAT Changeover Temp plus 2° Fahrenheit (+16.67 Celsius), the SAT Changeover Mode is set to Heat. The default changeover temperature is 74° Fahrenheit (23.33 Celsius).

See the topic Discharge Air Temperature (DAT) limiting on page 37 and Input sources on page 34.

Discharge Air Temperature (DAT) Limiting

To utilize Discharge Air Temperature (DAT) Limiting, a Discharge Air Temperature (DAT) sensor is required to control VAV units with reheat. If a DAT sensor is detected and DAT Limiting is enabled, the VAV terminal will be controlled by the DAT loop. The unit will also limit the Discharge Air Temperature to within 15° F of the Space Temp Reference.

When there is a call for heat and the primary air is cool air, the reheat outputs are directly controlled by the DAT Loop and the DAT Set point reset based on the output of the Heating loop. As the Heating loop increases from 0% to 50%, DAT Set point is proportionally calculated between Space Temp Reference and Space Temp Reference + 15° F up to maximum 90° F. This allows the reheat to be controlled by the DAT loop over the first 50% of a call for heating.

Figure 8-1 DAT limiting operation

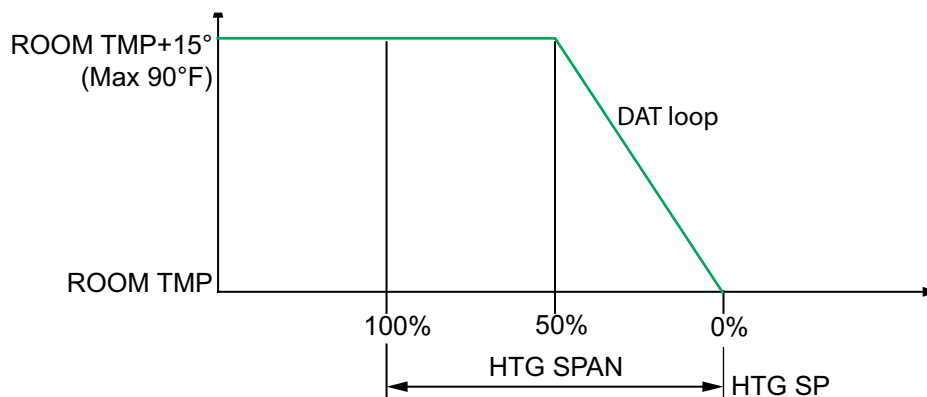

If DAT Limiting is enabled, and a DAT sensor is not connected, the controller will lockout reheat control only in the cooling mode. The unit will operate this way until a DAT sensor is detected or until the unit is commanded to control to the Active Heating Set point by a supervisory BMS.

If the unit has detected a DAT sensor and DAT Limiting is not enabled, the unit's reheat is controlled by the Heating loop instead of the DAT loop.

If DAT Limiting is not enabled, and a DAT sensor is not connected, the controller will satisfy a call for heat with the auxiliary flow and heating coil.

See also the topics *Changeover* on page 36 and *Input sources* on page 34

System Diagnostics

The controller programming includes four system diagnostic indicators in the form of BACnet value objects.

- Need for higher static pressure
- Need for cooler supply air
- Need for warmer supply air
- Need AHU start

These diagnostic indicators or flags are monitored by other BACnet devices connected to the same building automation system as the controller. How the indicators are used is beyond the scope of these instructions.

Need for higher static pressure The Need Higher Static value object is set to True (1) when the damper is fully open and airflow cannot reach the required set point value.

Need for cooler supply air The Need Cooler Supply value object is set to True (1) when the damper is fully open and the Cooling loop is greater than 95% for 30 minutes. The indicator changes to False (0) when the Cooling loop falls below 90%.

Need for warmer supply air The Need Warmer Supply value object is set to True (1) when the damper is fully open and the Heating loop is greater than 95% for 30 minutes. The indicator changes to False (0) when the Heating loop falls below 90%.

Need AHU start The Need AHU Start value object is set to True (1) for any of the following conditions.

- The system mode is Unoccupied and the Cooling loop or the Heating loop reaches 100%.
- The system mode is Occupied.
- The system mode is Standby.

The Need for AHU Start object changes to False (0) when both loops drop below 5%.

Damper Operation

Damper movement is determined by comparing the actual airflow reading to the airflow set points. If the actual airflow is within 5% of the set point, no damper action is initiated. Once within the 5% deadband, the actual airflow must be outside a 7% deadband before damper position changes.

Fan Operation

The EZvav controllers support both series and parallel fan powered VAV units. For either type of fan operation, the fan is controlled through the following terminals.

- A binary output triac controls a 24-volt fan starting circuit. See the topic Configuring the VAV Terminal Unit options on page 17 for the procedure to configure the controller for a fan.
- A 0-10 volt DC analog output controls the speed of the fan. The output controls fan speed at either Min Fan Speed or Max Fan Speed. See the topic Set the airflow set points on page 19 for the procedure to set the fan speeds.

If the VAV unit is not configured for a fan, the two outputs are not used and remain inactive regardless of the occupancy state.

Series Fan

If the controller is configured for a series fan, any time the Occupancy mode of the controller is set to either Occupied or Standby, the fan runs continuously. The fan speed is set to Maximum Fan Speed when the state is Occupied and set to Minimum Fan Speed when the state is Standby.

When the Occupancy state is Unoccupied, the fan starts and runs at minimum speed only on a call for heating. The fan starts when the Heating loop is greater than 5% and stops when the Heating loop is less than 1%.

Figure 8-2 Series fan operation

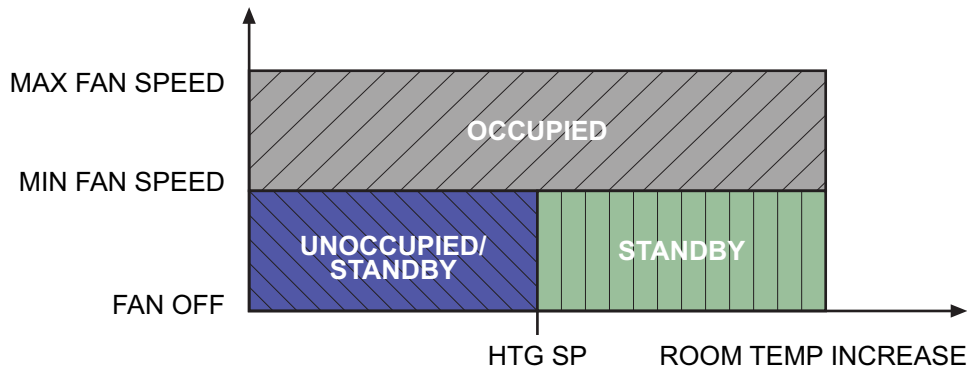

Parallel Fan

If the controller is configured for a parallel fan, any time the Occupancy mode of the controller is set to either Occupied or Standby and there is a call for heat, the fan runs continuously. The fan starts when the Heating loop is greater than 5% and stops when the Heating loop is less than 1%.

When the unit Occupancy state is Unoccupied, the fan starts and runs at minimum speed only on a call for heating. The fan starts when the Heating loop is greater than 5% and stops when the Heating loop is less than 1%.

Figure 8-3 Parallel fan operation

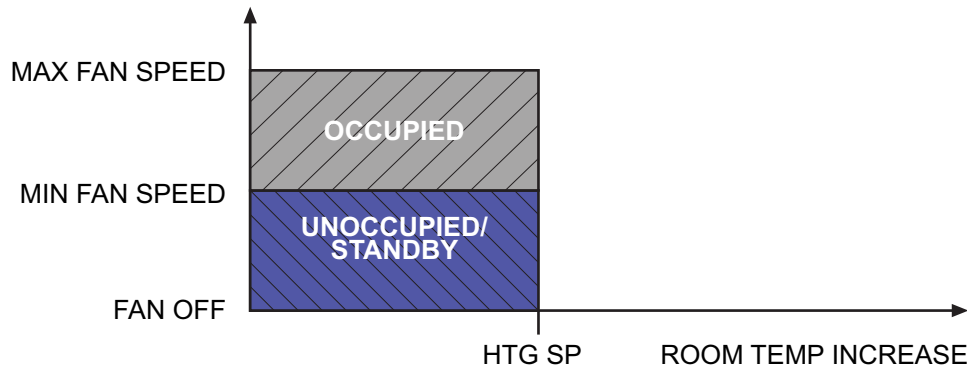

Reheat Sequence

The EZvav controllers can control three types of reheat installations.

- Modulating reheat
- Staged reheat
- Floating reheat

All reheat is controlled by either the Heating loop or the Discharge Air Temp Limiting (DAT) PID loop. Loops are described in the topic PID control loops on page 36.

- If Discharge Air Temp Limiting is enabled, reheat is controlled by the DAT PID loop.
- If DAT control is not enabled, reheat is controlled by the Heating loop.

In the following descriptions, the loop controlling reheat is referred to as the Reheat loop.

Modulating reheat

If the controller is configured for modulating reheat, it controls an analog reheat unit with 0-10 volts DC at the analog reheat output. On a call for reheat, the reheat output is modulated over the span of the Reheat loop. If the Reheat loop is less than 10%, the reheat output remains at zero. The reheat is set to zero if the Cooling loop is active.

See the topic Modulating reheat on page 31 for an application drawing.

Figure 8-4 Modulating reheat operation

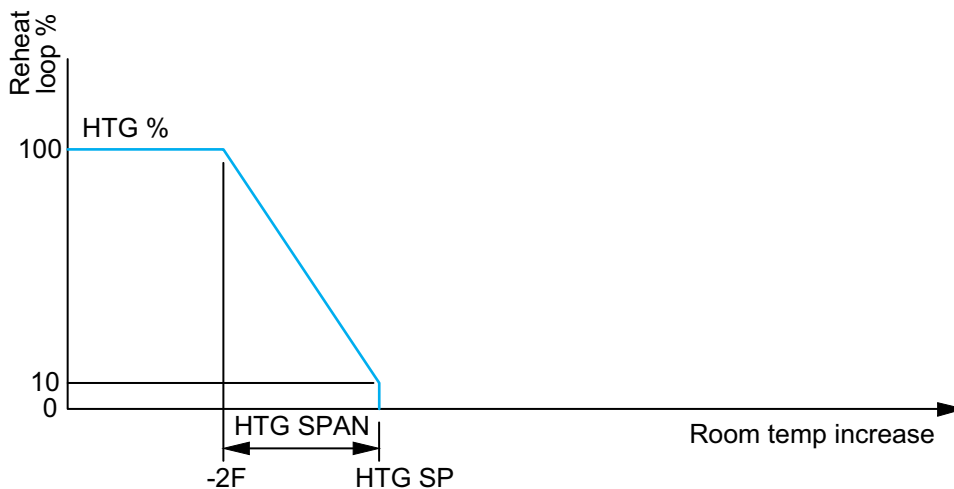

Staged reheat

If the controller is configured for staged reheat, it can control up to three stages of reheat through binary triac outputs. The reheat outputs are commanded On when the Reheat loop rises above the On threshold and Off when the loop drops below the Off threshold. Thresholds are described in the following chart, Staged reheat thresholds on page 39.

See the topic Staged reheat on page 30 for an application drawing.

Table 8-1 Staged reheat thresholds

Heating Stage	Output State	
	On threshold	Off threshold
Stage 1	35%	15%
Stage 2	65%	45%
Stage 3	95%	75%

Floating reheat

If the controller is configured for floating reheat, it controls two binary triac outputs to drive the inputs of a tri-state actuator connected to a valve. If the Reheat loop is less than 30%, the valve is driven closed. If the loop is greater than 70%, the valve is driven open. If the loop is in between 30% and 70%, no valve action is taken.

See the topic Floating reheat on page 32 for an application drawing.

Figure 8-5 Floating reheat operation

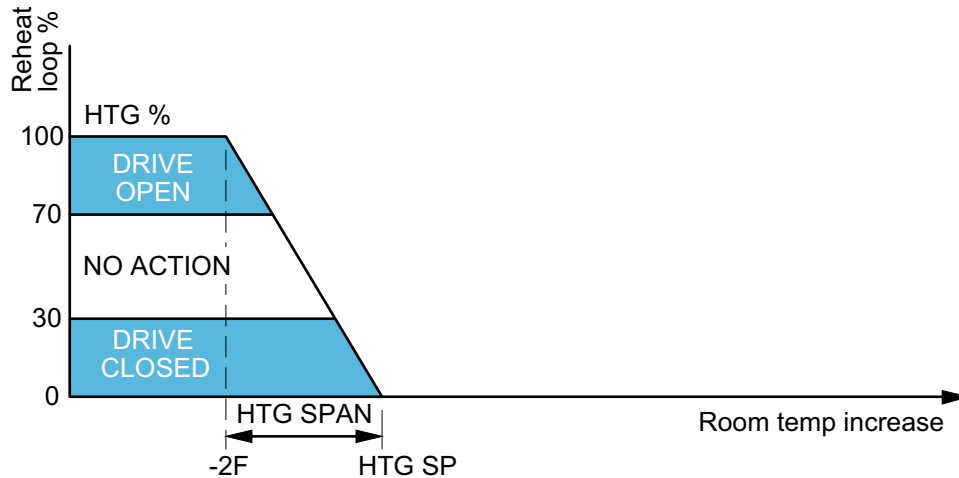

Balancing Airflow Sequence

Balancing airflow is the process of calibrating the internal airflow sensor to a known standard. In the field, airflow is measured with an airflow hood or other measuring instrument and then compared to the airflow measurements from the sensor in the controller. The balancing process uses an STE-8001W36 or STE-8201W36 as the technicians setup tool for initiating the balancing sequence and entering actual flow measurements.

When the balancing sequence starts, all other functions of the controller are locked out.

At the start of the sequence, the controller drives the damper open until the airflow reaches the highest value of either the cooling or heating maximum airflow set points. An airflow measurement is made with an airflow hood and the actual airflow value is entered into the controller. Once the actual airflow is entered, the controller drives the damper closed to the lower value of either the cooling or heating minimum airflow. Another measurement is made with the flow hood and that measurement is entered into the controller.

After the minimum airflow measurement is entered, the programming in the controller calculates airflow correction factors which are used to adjust measurements from the internal airflow sensor. Balancing is complete and the controller is returned to normal operation.

See the topic Balancing airflow on page 24 for the procedure to balance the airflow with an STE-8001W36.

Dual Duct

A dual duct installation consists of separate primary heating and cooling ducts, both with control dampers and airflow monitoring. For this type of installation a EZvav BAC-8007-36 controls the cooling air (primary) damper and a TSP-8001-36 actuator controls the heating air (secondary) damper.

- As the space temperature rises above the cooling set point, the primary airflow is modulated from the Cooling Minimum flow to the Cooling Maximum Flow.
- As the space temperature falls below the heating set point, the secondary airflow is modulated from the Heating Minimum flow to the Heating Maximum Flow.
- Between the heating and cooling set points, both the primary airflow and secondary airflow are modulated to maintain the Dual Duct Minimum airflow.

See the topic, Dual duct application on page 33 for an application drawing.

Figure 8-6 Dual duct sequence

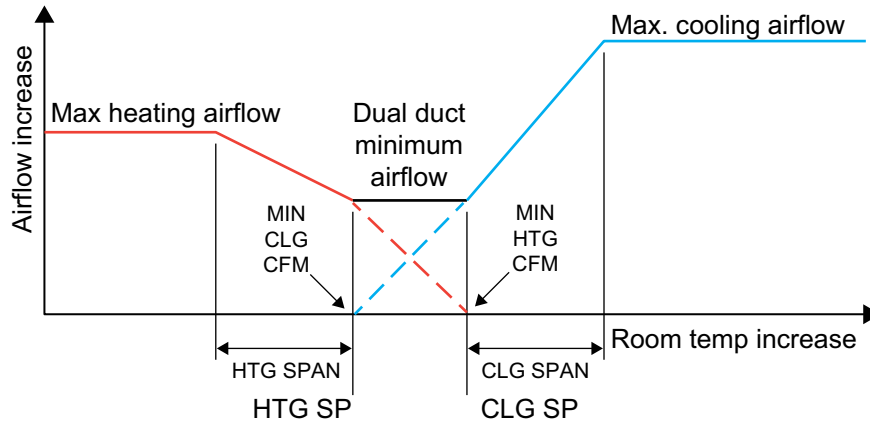

Section 9: System Integration and Networking

Topics in this section cover integrating the controllers into a building automation network. These are advanced reference topics for control technicians and engineers.

The controllers can be installed as standalone controllers or they can be connected to a BACnet MS/TP network. The topics in this section are reference material for control technicians or engineers who are planning, installing, and setting up controllers that are connected to a network.

In addition to the information in this section, you will also need the following information.

- Detailed plans and drawings for the building automation system.
- Information about the facility LAN including routers, switches, and network firewalls.
- Sequences of operation for other BACnet devices that will monitor or interact with EZvav controllers.

Integration topics

Connecting to an MS/TP network.....	41
Setting up network communications.....	42
BACnet objects	44

Connecting to an MS/TP network

EZvav controllers are BACnet MS/TP compliant controllers. Connect them only to a BACnet MS/TP network.

To enter the BACnet device instance, MAC address, and network baud, see the topic Setting up network communications on page 42

Figure 9-1 MS/TP network wiring and EOL switches

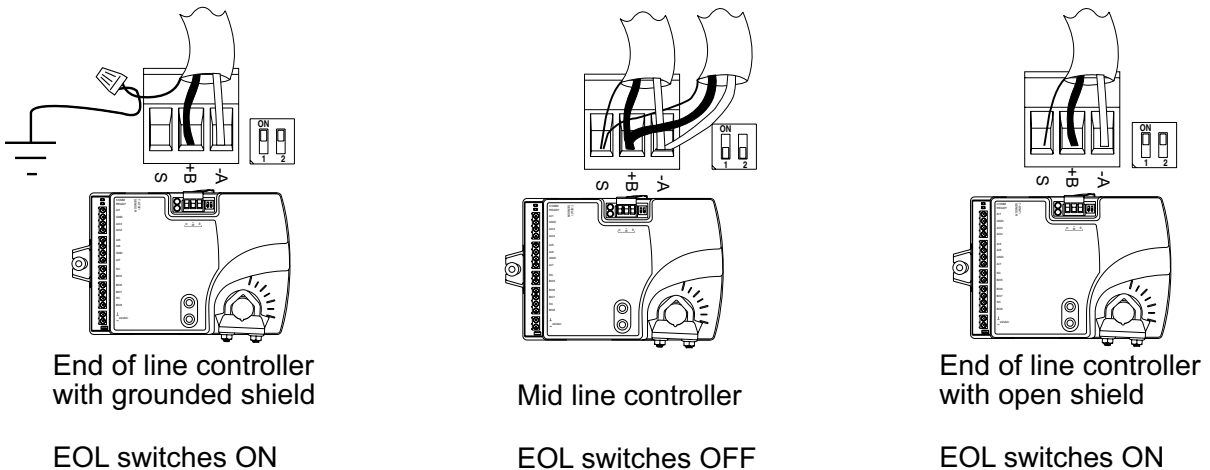

Connections and wiring

Use the following principles when connecting a controller to an MS/TP network:

- Connect no more than 128 addressable BACnet devices to one MS/TP network. The devices can be any mix of controllers or routers.
- To prevent network traffic bottlenecks, limit the MS/TP network size to 60 controllers.
- Use twisted pair, shielded cable with capacitance of no more than 51 picofarads per foot for all network wiring. Belden cable model #82760 meets the cable requirements.
- Connect the -A terminal in parallel with all other - terminals.
- Connect the +B terminal in parallel with all other + terminals.
- Connect the shields of the cable together at each mid line controller. For EZvav controllers use the S terminal.
- Connect the shield to an earth ground at one end only.
- Use repeater between every 32 MS/TP devices or if the cable length will exceed 4000 feet (1220 meters). Use no more than four repeaters per MS/TP network.
- Place a surge suppressor in the cable where it exits a building.

End of line termination switches

The controllers on the physical ends of the EIA-485 wiring segment must have end of line termination added for proper network operation.

- For controllers at the end of the network set the EOL switches to On
- For mid line controllers at the end of the network set the EOL switches to Off

Network bulbs

- EZvav controllers include network bulbs located near the MS/TP network connector. These bulbs serve three functions:
- Removing both bulbs will disconnect the controller from the MS/TP network.
- If one or both bulbs are lit, it indicates the network connection or controller power is not properly wired.
- If the voltage or current on the network exceeds safe levels, the bulbs may open and protect the controller from damage.

Bulbs are illuminated If one or both bulbs are illuminated, it indicates the network is not phased correctly. The ground potential of the controller is not the same as other controllers on the network. The brighter the isolation bulbs on a controller are illuminated, the closer that controller is to the source of the problem. Remove power and check the network and power connections.

Bulbs are open If one or both bulbs are open – as tested with an ohm meter – it indicates the voltage or current on the network exceeded safe levels. Correct the conditions and replace the bulbs.

Bulbs not inserted correctly One lead from one or both of the bulbs are not inserted into the socket.







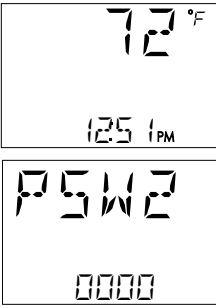

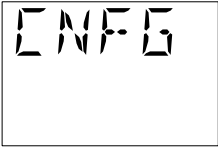

Setting up Network Communications

Set the network communication settings before placing a controller on the network. Setting network settings requires entering Password 2 which is described in the topic Getting started with configuration on page 14.

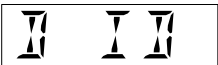
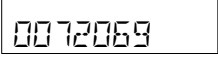
Procedure to set up network communications

PROCEDURE	STEPS	STE DISPLAY
<p>1 Starting display.</p>	<p>1. Start at the temperature display.</p> <p>2. Press the Δ and ∇ buttons together.</p> <ul style="list-style-type: none"> • If Password 2 is not required, the display changes to ENFG. • If required, enter Password 2. The display changes to ENFG when Password 2 is correct. 	

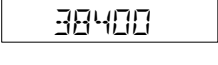
Procedure to set up network communications (continue)

PROCEDURE	STEPS	STE DISPLAY
<p>2 Select the CNFG display.</p>	<p>1. From the CNFG display, press the Δ or ∇ buttons to advance to COMM display.</p> <p>2. Press the  button. The display advances to IIII.</p>	 
<p>3 Enter the device instance.</p>	<p>1. Press the Δ or ∇ buttons to change the first digit.</p> <p>2. Press the  button to select the next digit. Repeat for all seven digits.</p> <p>3. When the  button is pressed for the last digit, the display changes to MAC.</p>	 
<p>4 Enter the MAC address.</p>	<p>1. Press the Δ or ∇ buttons to change the MAC address.</p> <p>2. Press the  button to save the selected MAC address.</p> <p>The display changes to IIII.</p>	
<p>5 Enter the baud.</p>	<p>1. Press the Δ or ∇ buttons to select a new baud.</p> <p>2. Press the  button to save the selected baud.</p> <p>The display returns to COMM.</p>	 
<p>6 Advance or exit.</p>	<p>1. Press the Δ or ∇ buttons to select one of the following:</p> <ul style="list-style-type: none"> • LINE or CNFG options • EXIT to return to the temperature display. <p>2. Press the  button to select the next function</p>	

BACnet Objects

The EZvav controllers are BACnet Application Specific Controller (ASC) that are composed of standard BACnet objects. This section lists the objects that are likely to be monitored by a standard BACnet operator workstation to verify system operation.



CAUTION Choosing RSTR deletes all previously configured values including balancing values and passwords. Only the BACnet communications settings will remain unchanged.

Input objects

The following BACnet input objects represent values at the physical inputs of the controller. For wiring details, see the topic Application drawings on page 29.

Table 9–2 Input objects

Input	Name	Description	Object Type
AI1	DISCHARGE AIR	Discharge Air Temperature	KMC10K_Type_III
AI2	SPACE SENSOR	Space Sensor	KMC Type II Deg F
AI3	SPACE SET POINT	Space Set point	TABLE_4
AI4	PRIMARY DUCT	Primary Duct Pressure	
AI5	SECONDARY DUCT	Secondary Duct Pressure	

Output objects

The following BACnet output objects represent values at the physical outputs of the controller. For application specific output wiring details, see the topic Application drawings on page 29.

Table 9–3 Output objects

Output	Name	Description	Unit
AO3	ANALOG HEAT	Analog Heat	0_100%
AO4	FAN SPEED	Fan Speed	0_100%
BO1	DAMPER CW	Damper Clockwise	
BO2	DAMPER CCW	Damper Counter Clockwise	
BO5	FAN	Fan	
BO6	HT STAGE 1	Heating Stage 1	
BO7	HT STAGE 2	Heating Stage 2	
BO8	HT STAGE 3	Heating Stage3	

Value objects

BACnet value objects represent set points or other operational conditions in the controller.

Note: *Not all objects are present in every model.*

Table 9–4 Analog value objects

Object	Name	Description
AV1	SPACE TEMP	Space Temperature
AV2	STPT REFERENCE	Set point Reference
AV3	ACT COOL STPT	Active Cooling Set point
AV4	ACT HEAT STPT	Active Heating Set point
AV5	OCC CL STPT	Occupied Cooling Set point
AV6	OCC HT SPT	Occupied Heating Set point
AV7	UNOCC CL STPT	Unoccupied Cooling Set point

Installation and Operation Manual • EZvav Digital Controls

Table 9–4 Analog value objects (continue)

Object	Name	Description
AV8	UNOCC HT STPT	Unoccupied Heating Set point
AV9	MIN CL STPT	Minimum Cooling Set point
AV10	MAX HT STPT	Maximum Heating Set point
AV11	MIN STPT DIFF	Minimum Set point Differential
AV12	STBY DIFF	Standby Differential
AV13	MIN COOL FLOW	Minimum Cooling Flow
AV14	MAX COOL FLOW	Maximum Cooling Flow
AV15	MIN HEAT FLOW	Minimum Heating Flow
AV16	MAX HEAT FLOW	Maximum Heating Flow
AV17	AUXILIARY FLOW	Auxiliary Flow
AV18	PRI K FACT	Primary K Factor
AV19	PRI CORR SLOPE	Primary Correction Slope
AV20	PRI CORR OFFST	Primary Correction Offset
AV21	PRI LO FLOW CORR	Primary Low Flow Correction
AV22	PRI FLOW STPT	Primary Flow Set point
AV23	PRI RAW FLOW	Primary Raw Flow
AV24	PRI ACTUAL FLOW	Primary Actual Flow
AV32	MIN FAN SPEED	Minimum Fan Speed
AV33	MAX FAN SPEED	Maximum Fan Speed
AV36	DAT STPT	Discharge Air Temp Set point
AV37	SAT CHANGEOVER	SAT Changeover Temperature
AV38	LOCAL OVRD TIME	Local Override Timer
AV39	STANDBY TIME	Standby Timer (motion)
AV40	STANDBY TRIGGER	Standby Trigger
AV43	MEASURED MAX	Measured Maximum
AV44	MEASURED MIN	Measured Minimum
AV45	PRI SAVE MIN FLO	Primary Saved Minimum Airflow
AV47	DAT MAXIMUM	Maximum DAT Set point
AV48	CW DMP POS	CW Damper Position (BAC-8205-36 only)
AV49	CCW DMP POS	CCW Damper Position (BAC-8205-36 only)
AV50	DAMPER POSITION	Damper Position (BAC-8205-36 only)
AV55	CHNG_OVER_DELAY	Cooling Change Over Delay
AV56	LOW AUTO OCC	Low Limit for Auto Occupy

Table 9–5 Binary value objects

Object	Name	Description
BV1	NEED AHU	Need For AHU
BV2	NEED COLDER SPLY	Need For Colder Air Supply
BV3	NEED MORE STATIC	Need For AHU
BV4	LOCAL OVRD	Local Override Mode
BV5	MOTION OVRD	Motion Override Mode
BV6	MOTION SENSOR	Motion Sensor (Wall Stat)
BV7	NEED HOTTER SPLY	Need For Hotter Air Supply
BV8	CHANGE OVER MODE	SAT Changeover Mode
BV9	DAT LIMITING	Discharge Air Temp Limiting
BV10	CLOCKWISE CLOSE	Clockwise Close
BV11	AUTO OCCUPANCY	Auto Occupancy Detection
BV12	BALANCE MODE	Balance Mode
BV13	DAT SENSOR	DAT Sensor Present
BV14	PRI BAL TRIGGER	Primary Balance Trigger

Table 9–6 Multistate value objects

Object	Name	Description
MSV1	OCCUPIED MODE	Occupied Mode
MSV2	FAN CONFIG	Fantype Configuration
MSV3	REHEAT	Reheat Type
MSV6	WALL SENSOR	Multi-state Value #6

Loop objects

BACnet PID loops are used for modulating the damper and controlling reheat.

Table 9–7 PID control loop objects

Object	Name	Description
LOOP1	CL LOOP	Cooling Loop
LOOP2	HT LOOP	Heating Loop
LOOP3	DAT Loop	Discharge Air Temp Loop

Diamond Flow Sensor K-Factors for VAV Terminal Units

Model Series:

- 3000** Single Duct
- 3210** Dual Duct
- 35S-OAI** Series Fan Powered w/ O.A. Damper
- 38S** Underfloor Fan Powered

Inlet Size	Type	Duct Area (sq. ft.)	K-Factor (cfm)	Velocity (fpm)	F-Factor (amp.)	
4	ROUND	0.087	182	2092	3.67	
5		0.136	325	2390	2.81	
6		0.196	455	2321	2.98	
7		0.267	657	2461	2.65	
8		0.349	899	2576	2.42	
9		0.442	1158	2620	2.34	
10		0.545	1497	2747	2.13	
12		OVAL	0.754	2058	2729	2.15
14			0.970	2554	2633	2.31
16			1.186	3035	2559	2.45
24 x 16	RECT.	2.667	6797	2549	2.47	

Model Series:

- 36VRS** Square/Retangular Retrofit

Unit Size	Type	Damper (valve) Size (inches)	Damper (valve) Area (sq. ft.)	K-Factor (cfm)	Velocity (fpm)	F-Factor (amp.)
7	SQUARE OR RECT.	5 x 5	0.174	479	2753	2.12
8		6 x 6	0.250	689	2756	2.11
9		8 x 6	0.333	919	2760	2.11
10		10 x 8	0.555	1531	2759	2.11
11		14 x 8	0.778	2150	2763	2.10
11A		18 x 6	0.750	2068	2757	2.11
12		12 x 10	0.833	2297	2758	2.11
13		18 x 10	1.250	3446	2757	2.11
14		18 x 12	1.500	4135	2757	2.11
15		20 x 14	1.944	5360	2757	2.11
15A		30 x 12	2.500	6892	2757	2.11
16		22 x 16	2.444	6739	2757	2.11
17		24 x 18	3.000	8270	2757	2.11
18		30 x 20	4.167	11486	2756	2.11
19		40 x 20	5.555	15315	2757	2.11

Model Series:

- 30HQX** Single Duct Exhaust (Hospital Grade)
- 30X** Single Duct Exhaust

Unit Size	Type	Valve Inlet Size (inches)	Valve Inlet Area (sq. ft.)	K-Factor (cfm)	Velocity (fpm)	F-Factor (amp.)
4	SQUARE OR RECT.	3.4 x 3.4	0.080	210	2625	2.33
5		4.3 x 4.3	0.128	345	2695	2.21
6		5.5 x 5.5	0.210	580	2762	2.10
7		5.8 x 6.3	0.254	680	2677	2.24
8		6.7 x 7.2	0.335	970	2896	1.91
9		8.6 x 7.1	0.424	1209	2851	1.97
10		9.5 x 8.0	0.528	1539	2915	1.89
12		13.6 x 8.1	0.765	2269	2966	1.82
14		12.9 x 10.8	0.968	2521	2604	2.36
16		18.3 x 10.8	1.373	3586	2612	2.35
24 x 16		26.1 x 16.3	2.954	7009	2373	2.85

Model Series:

- 3100** Single Duct
- 3230** Dual Duct
- 3240** "Blendmaster" Dual Duct
- 35N** Parallel Fan Powered
- 35S** Series Fan Powered
- 35S-CVP** Pressurization Series Fan Powered
- 35SST** "Stealth™" Series Fan Powered
- 36VRR** Round Retrofit

Inlet Size	Type	Duct Area (Sq. ft.)	K-Factor (cfm)	Velocity (fpm)	F-Factor (amp.)
4	ROUND	0.087	182	2092	3.67
5		0.136	325	2390	2.81
6		0.196	455	2321	2.98
7		0.267	657	2461	2.65
8		0.349	899	2576	2.42
9		0.442	1158	2620	2.34
10		0.545	1497	2747	2.13
12		0.785	2048	2609	2.36
14		1.069	2742	2565	2.44
16		1.395	3683	2640	2.30
18	OVAL	1.683	4323	2569	2.43

Model Series:

- 37N** Low Profile Parallel Fan Powered
- 37S** Low Profile Fan Powered
- 37SST** Low Profile "Stealth™" Fan Powered

Inlet Size	Type	Duct Area (Sq. ft.)	K-Factor (cfm)	Velocity (fpm)	F-Factor (amp.)
4	ROUND	0.087	182	2092	3.67
5		0.136	325	2390	2.81
6		0.196	455	2321	2.98
8		0.349	899	2576	2.42
10		0.545	1497	2747	2.13
14 x 8	RECT.	0.777	2035	2619	2.34
14 x 10	RECT.	0.972	2417	2487	2.59

Equations:

$$Q = K \times \sqrt{\Delta P} \quad \Delta P = \left(\frac{Q}{K}\right)^2 \quad F = \left(\frac{4005 \times A}{K}\right)^2$$

Where: Q = Airflow Rate (cfm)

ΔP = Sensor Differential Pressure ("w.g.)

K = K-Factor Calibration Constant (standard air)

F = Amplification Factor (sensor gain)

A = Nom. Duct Area (sq. ft.)

The K-Factors tabulated in the above tables are the air-flow required to produce a 1.0" w.g. differential pressure at the Diamond Flow Sensor.

For most up to date Diamond Flow Sensor K-Factors for VAV Terminal Units "IOM-VAVK" go to www.nailor.com

For additional information regarding the content of the material, please contact Nailor for further assistance or go to nailor.com

Accessories and replacement parts

The following accessories and replacement parts are available from Nailor.

Controllers/Actuators:

BAC-8001-36	EZvav Digital Controller (Single Duct Cooling only)
BAC-8005-36	EZvav Digital Controller (Single Duct ReHeat and Fan Powered)
BAC-8007-36	EZvav Digital Controller (Dual Duct Master)
TSP-8001-36	EZvav Digital Controller (Dual Duct Slave)

Room Temperature Sensors (Thermostat):

STE-8001W36	EZvav Room Temperature Sensor - digital display
STE-8201W36	EZvav Room Temperature Sensor - digital display with motion sensor
STE-6014W36	EZvav Room Temperature Sensor - Rotary dial
STE-1401	Air Temperature sensor (HCCO, DAT)

Communication Cables:

ECRJ45-25	Ethernet cable RJ-45, 25 ft.
ECRJ45-35	Ethernet cable RJ-45, 35 ft.
ECRJ45-50	Ethernet cable RJ-45, 50 ft.
ECRJ45-75	Ethernet cable RJ-45, 75 ft.

Diamond Flow Sensors:

Inlet Size		P/N
4"	3/16" O.D. tube	V1104
5"	3/16" O.D. tube	V1105
6"	3/16" O.D. tube	V1106
7"	3/16" O.D. tube	V1107
8"	3/16" O.D. tube	V1108
9"	3/16" O.D. tube	V1109
10"	3/16" O.D. tube	V1110
12"	3/16" O.D. tube	V1112
14"	3/16" O.D. tube	V1114
16"	3/16" O.D. tube	V1116
18"	3/16" O.D. tube	V1118