

# **HORIZONTAL HIGH CAPACITY & LOW PROFILE – DUCTED**



## Model Series 35FH • Direct Drive Draw-through Design

**B**

**HORIZONTAL FAN COIL UNITS • DUCTED**

**Filter**

- 1" (25) throwaway (standard)
- 2" (51) MERV 8 or MERV 13 pleated (optional)

**Multiple coil options:**

- 3, 4, 5, 6 row cooling or heating coils
- 1 or 2 row preheat or reheat coil



Removable electric heater rack, easily accessible within a hinged cabinet enclosure

Coil enclosure with fiber-free – foam insulation for increased thermal efficiency.

18 ga. (1.31) galvanized formed steel frame

Primary drain outlet  
Secondary drain outlet

Optional filter rack with hinged doors and latch. Available on side and bottom for ducted inlet application.

**Comprehensive liner options**

- 3/4" (19) or 1" (25) D.D. fiberglass
- Steri-liner (foil faced)
- Fiber-free (closed cell foam)
- Perforated metal with insulation

Blower/Motor assembly; isolated from fan housing

- 3-speed PSC
- Multi-speed ECM
- EPIC ECM

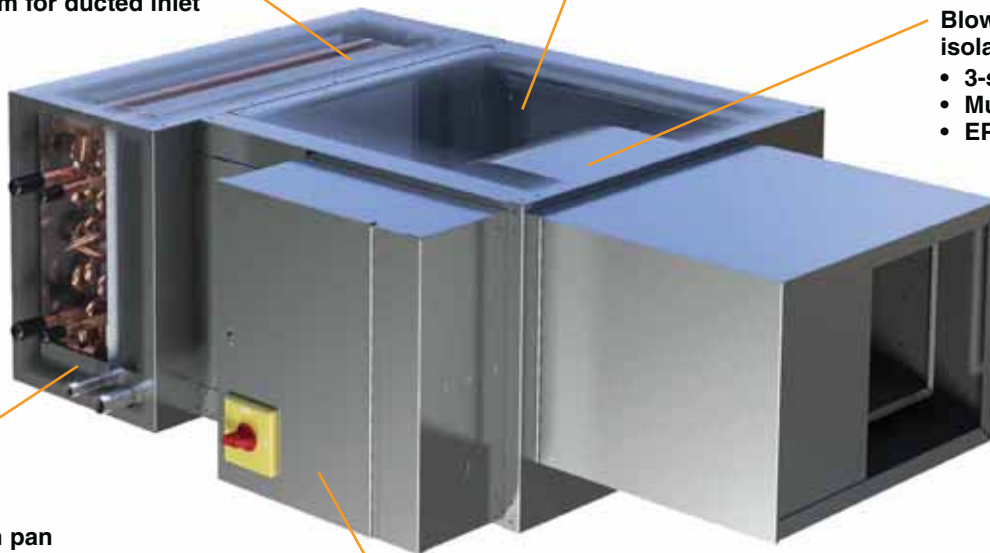

Insulated drain pan  
• Galvanized or Stainless Steel  
• Optional secondary overflow drain connection

Hinged door control enclosure will accept a toggle disconnect or a door interlocking type and can accommodate controls for BAS Communications.

## High Performance Direct Drive Draw-through Horizontal Fan Coil Units Model Series 35FH

The Engineered Comfort 35FH Series fan coil accommodates a variety of applications, designed typically for installation above a ceiling where a high capacity is required. Twelve nominal sizes are offered, ranging from 400 – 4000 CFM (189 – 1888 l/s) or 1 to 10 tons with external static pressure up to 1.0" (249 Pa).

Completely assembled and shipped from the factory with the desired controls and options to minimize field installation time and cost.

The 35FH's Direct Drive draw-through design provides the following benefits:

- The Direct Drive blower motor assembly eliminates the belt drive maintenance and drive loss typically associated with a belt driven unit.
- A draw-through design pulls air through the entire face of the coil providing a more even air velocity and consequently better heat transfer and less air pressure drop.
- Less air turbulence is created due to the design's ability to draw the air into the coil rather than forcing it, making the draw-through sound levels lower due to the even velocities, this is compared to the blow-through where face velocities are concentrated around the blower discharge area of the coil, increasing air turbulence.
- Reduced air pressure drop and greater coil heat transfer in the draw-through design allows for lower energy consumption.
- Direct Drive blower/motor assembly reduces the amount of sound transmission to the occupant.
- Industry leading performance utilizing EPIC Fan Technology®.
- Performance customization through Nailor's selection program, 'SelectWorks'.

Data derived from independent tests conducted in accordance with AHRI Standard 880.

AHRI certified units available as:

2-pipe hydronic system:

- 1, 2 or 3 row coil for heating only.
- 3, 4, 5 or 6 row coil for cooling only.
- 3, 4, 5 or 6 row coil for cooling or heating.

2-pipe hydronic system with 1, 2 stage or SCR control electric heat

- 3, 4, 5 or 6 row coil and up to 50 kW.

4-pipe hydronic systems:

- 3, 4, 5 or 6 row cooling coil and 1 or 2 row heating coil.
- Either as reheat or preheat.

### Standard Features

#### CONSTRUCTION

- ETL Listed. Constructed in compliance with ANSI / UL Standard.
- 18 ga. (1.31) galvanized steel channels frame with 20 ga. (1.00) casing components.
- Coil casing insulated with 3/4" (19) fiber-free closed cell insulation. Other panels insulated with dual density fiberglass insulation.
- 1" (25) Throwaway filter.
- Easily removable bottom and side access panels.
- Discharge opening designed for flanged duct connection.
- Electrical enclosure with hinged access door.

#### FAN/MOTOR ASSEMBLIES

- Forward Curved, DWDI, direct driven blowers.
- Blower/motor assembly isolated from fan housing with vibration isolators.
- Motor power leads with quick disconnect brought into an external hinged door starter-control enclosure.
- PSC, Multi-Speed ECM or fully variable EPIC ECM.
- 120, 208, 240 and 277 volt single phase motor.

#### COILS

- Water coils with copper tubes and aluminum ripple fins. Performance rated and certified in accordance with the current edition of AHRI Standard 410.
- Coils installed in an insulated casing with 3/4" (19) fiber-free(closed cell) insulation for increased thermal efficiency.

#### DRAIN PANS

- Positively sloped galvanized steel drain pan with 3/4" (19) male NPT connection, which meets the requirements of ASHRAE 62.1.
- Externally insulated with fiber-free foam.

## High Performance Direct Drive Draw-through Horizontal Fan Coil Units (continued)

Models: 35FHW, 35FHZ, 35FHZW and 35FHZE



35FHW Unit size 40 with EPIC ECM Motor, Optional Controls Enclosure and Optional Ducted Filter Rack Connection

### Options and Accessories

#### CONSTRUCTION

##### Insulation

- Dual density fiberglass.
- Fiber-free.
- Steri-liner.
- Perforated metal.
- Steri-liner with perforated metal.
- 1" (25) or 2" (51) Filter Rack with hinged doors and latches on the side and bottom for ease of maintenance.
- 1" (25) Throwaway.
- 2" (51) MERV 8 or MERV 13.

#### COILS

- Manual or Automatic air vent(s) with valve package.
- Coil Casing 20 ga. (1.00) stainless steel drain pan externally insulated with fiber-free foam.
- Stainless steel coil casing.
- Increased tube wall thickness 0.025" (0.635).

#### DRAIN PANS

- Stainless Steel drain pan externally insulated with fiber-free foam.
- 5/8" (15.9) Secondary (overflow) drain connection with or without overflow safety switch.

#### CONTROL PACKAGES

- Toggle Disconnect Switch.
- Door Interlocking disconnect switch.
- Main Unit Fusing.
- Quiet Contactors.
- Airflow switches.
- Manual reset hi-limit.
- 24V transformer and fan relay packages.
- Digital EZstat controller with BACnet operation or Stand-alone control.
- On-Off or Modulating controls.
- Dust tight control enclosure.
- Factory installed controls – provided by others.

#### VALVE-PIPING PACKAGES

- Factory assembled and Installed in enclosure or field installed.
- 1/2", 3/4" or 1" (13, 19 or 25) 2 or 3 way valves.
- On/Off, 24V or 115V, modulating 0 – 10 vdc.
- Unions, P/T ports and Shut-off valves.
- Circuit setters (manual or auto-fixed flow control).
- Strainers.

#### OTHER OPTIONS

- Hanger Mounting Brackets.
- LH or RH Control/Coil Connection.
- Mixing Box.
- Outside Air Dampers.
- Ultraviolet Light.
- Condensate Pumps.

## Model Series 35FH • Direct Drive Draw-through • EPIC ECM, 3-Speed ECM and PSC Motor • 2-pipe or 4-pipe • Unit Sizes 4 – 16

### MODELS:

- 35FHZ** Chilled/Hot water (2-pipe).
- 35FHW** Hot water (2-pipe).
- 35FHZW** Chilled & hot water (4-pipe).

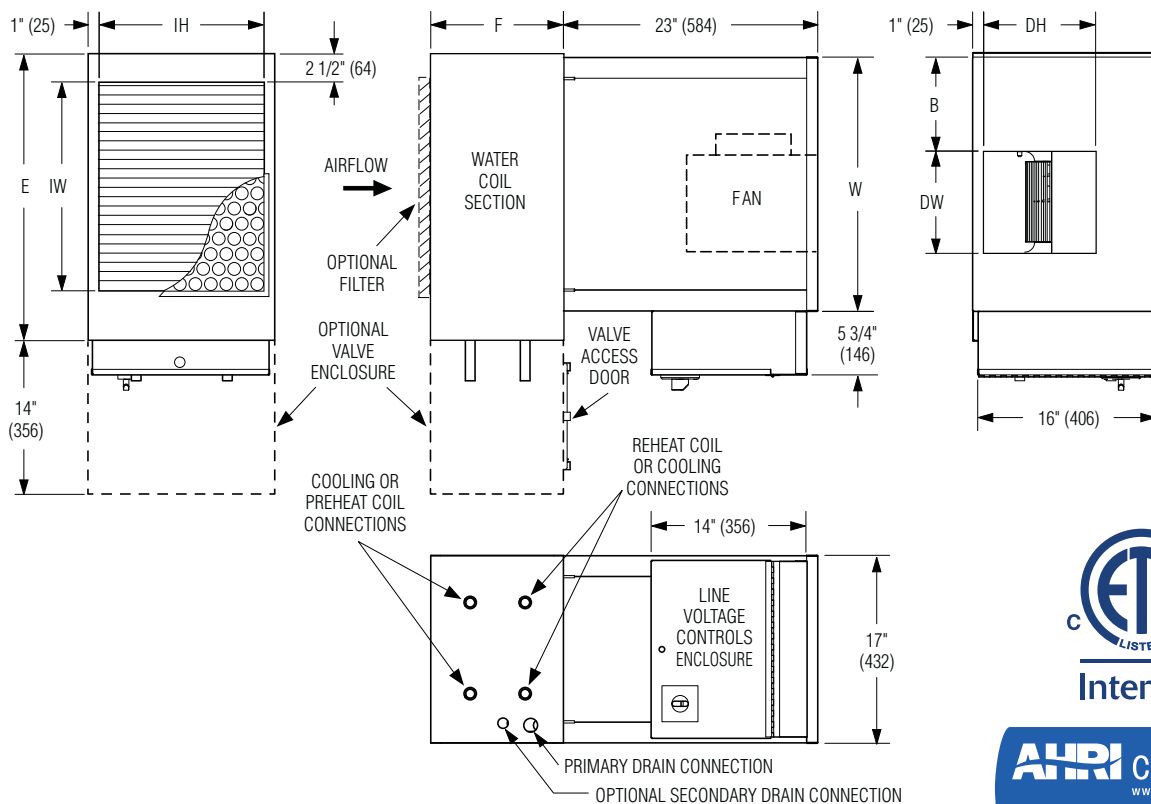

### Dimensional Data

Unit Size	Nominal CFM (l/s)	W	B	E	F	Inlet IW x IH	Outlet Discharge DW x DH	Filter Size W x H
4	400 (189)	23 (584)	8 1/2 (216)	26 (660)	<b>3, 4, 5 &amp; 6 ROW COIL:</b> 12 (305), <b>7 &amp; 8 ROW COIL:</b> 14 (356)	19 x 15 (483 x 381)	6 7/8 x 10 1/8 (175 x 257)	20 x 16 (508 x 406)
6	600 (283)						9 1/4 x 10 1/8 (235 x 257)	
8	800 (378)						9 1/4 x 10 1/8 (235 x 257)	
10	1000 (472)	37 (940)	16 (406)	40 (1016)		33 x 15 (838 x 381)	9 1/4 x 10 1/8 (235 x 257)	35 x 16 (889 x 406)
12	1200 (566)						11 7/8 x 10 1/8 (302 x 257)	
14	1400 (661)						11 7/8 x 10 1/8 (302 x 257)	
16	1600 (755)				13 1/4 x 11 1/4 (337 x 286)			

### Coil O.D. Sweat Connections

Unit Size	Number of Rows				
	1 & 2	3	4	5	6
4 – 8	5/8	7/8	7/8	7/8	7/8
10 – 16	5/8	7/8	7/8	7/8	1 1/8



## Model Series 35FH • Direct Drive Draw-through • EPIC ECM, 3-Speed ECM and PSC Motor • 2-pipe or 4-pipe • Unit Sizes 18 – 24

### MODELS:

- 35FHZ** Chilled/Hot water (2-pipe).
- 35FHW** Hot water (2-pipe).
- 35FHZW** Chilled & hot water (4-pipe).

**B**

**HORIZONTAL FAN COIL UNITS • DUCTED**

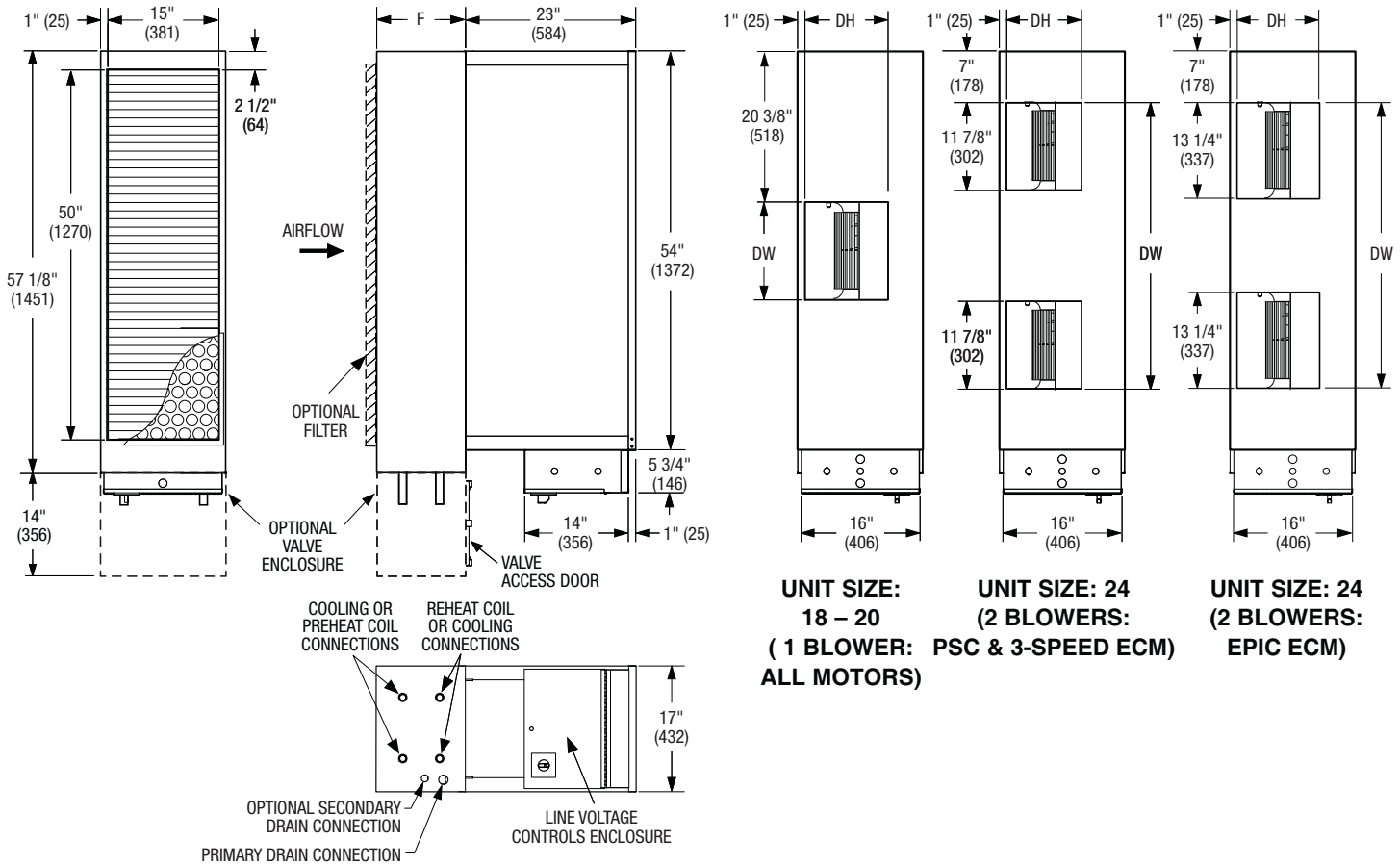

**UNIT SIZE: 18 – 20**  
**( 1 BLOWER: PSC & 3-SPEED ECM)**

**UNIT SIZE: 24**  
**(2 BLOWERS: PSC & 3-SPEED ECM)**

**UNIT SIZE: 24**  
**(2 BLOWERS: EPIC ECM)**

### Dimensional Data

Unit Size	Nominal CFM (l/s)	F	Outlet Discharge DW x DH	Filter Size W x H
18	1800 (849)	3, 4, 5 & 6 ROW COIL: 12 (305), 7 & 8 ROW COIL: 14 (356)	13 1/4 x 11 1/4 (337 x 286)	52 x 16 (1321 x 406)
20	2000 (944)		13 1/4 x 11 1/4 (337 x 286)	
24	2400 (1038)		39 1/4 x 10 1/8 (997 x 257) [PSC & 3-SPEED ECM] 39 1/4 x 11 1/4 (997 x 286) [EPIC ECM]	

### Coil O.D. Sweat Connections

Unit Size	Number of Rows				
	1 & 2	3	4	5	6
18 – 24	5/8	7/8	7/8	7/8	1 1/8



## Model Series 35FH • Direct Drive Draw-through • EPIC ECM Motor • 2-pipe or 4-pipe • Unit Sizes 30 and 40

### MODELS:

- 35FHZ** Chilled/Hot water (2-pipe).
- 35FHW** Hot water (2-pipe).
- 35FHZW** Chilled & hot water (4-pipe).

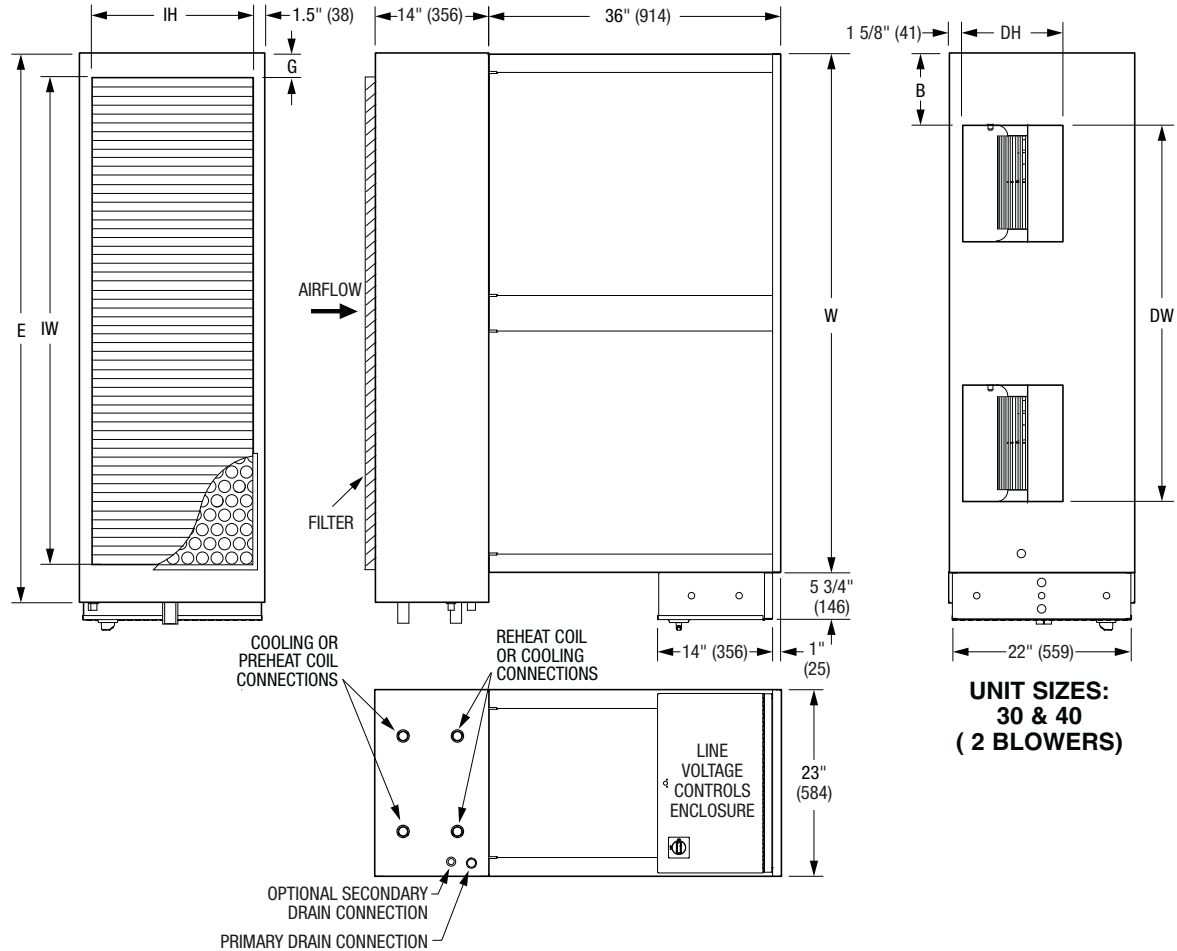

**UNIT SIZES:  
30 & 40  
( 2 BLOWERS)**

**B** HORIZONTAL FAN COIL UNITS • DUCTED

### Dimensional Data

Unit Size	Nominal CFM (l/s)	W	E	G	B	Inlet IW x IH	Outlet Discharge DW x DH	Filter Size W x H
30	3000 (1416)	54 (1372)	57 (1448)	2 3/8 (60)	7 (178)	50 x 20 (1270 x 508)	39 1/4 x 12 1/2 (997 x 318)	52 x 22 (1321 x 559)
40	4000 (1888)	64 (1626)	67 5/8 (1718)	2 7/8 (73)	8 5/16 (211)	60 x 20 (1524 x 508)	46 3/8 x 12 1/2 (1178 x 318)	62 x 22 (1575 x 559)



### Coil O.D. Sweat Connections

Unit Size	Number of Rows				
	1 & 2	3	4	5	6
30 & 40	7/8	1 3/8	1 3/8	1 3/8	1 3/8

# HORIZONTAL HIGH CAPACITY FAN COIL UNITS • DUCTED Engineered Comfort

**Model Series 35FH • Direct Drive Draw-through • EPIC ECM, 3-Speed ECM and PSC Motor • 2-pipe with Electric Heat • Sizes 4 – 16**

**MODEL:**

**35FHZE** Chilled/Hot water (2-pipe) with Electric Heat.

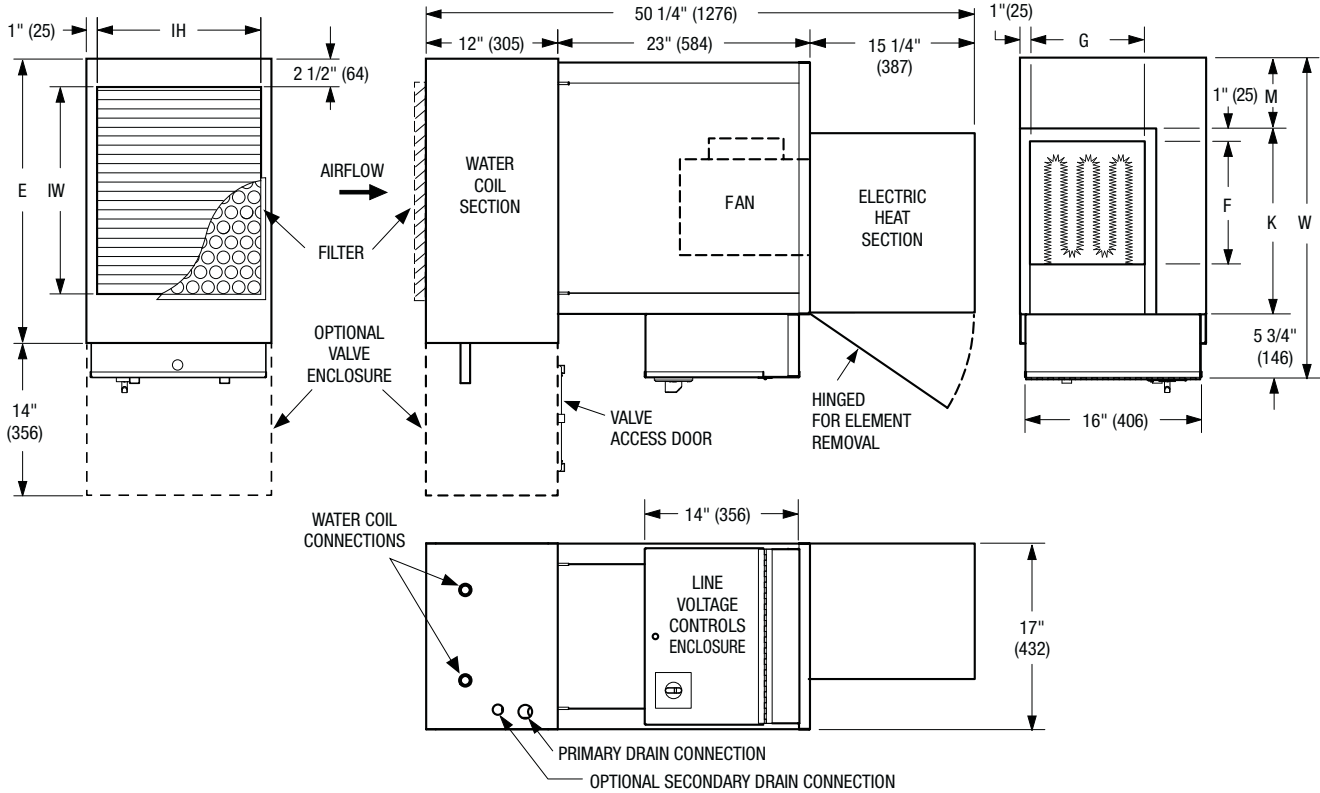

**Dimensional Data**

Unit Size	Nominal CFM (l/s)	W	E	Inlet IW x IH	Outlet Duct Size F x G	K	M	Filter Size W x H
4	400 (189)	28 3/4 (730)	26 (660)	19 x 15 (483 x 381)	8 7/8 x 10 1/2 (225 x 267)	16 1/2 (419)	6 1/2 (165)	20 x 16 (508 x 406)
6	600 (283)				11 1/4 x 10 1/2 (286 x 267)			
8	800 (378)				11 1/4 x 10 1/2 (286 x 267)			
10	1000 (472)	42 3/4 (1086)	40 (1016)	33 x 15 (838 x 381)	12 1/2 x 11 3/4 (318 x 298)	23 (584)	14 (356)	35 x 16 (889 x 406)
12	1200 (566)				13 7/8 x 11 3/4 (352 x 298)			
14	1400 (661)				13 7/8 x 11 3/4 (352 x 298)			
16	1600 (755)				15 1/8 x 11 3/4 (384 x 298)			

**Coil O.D. Sweat Connections**

Unit Size	Number of Rows			
	3	4	5	6
4 – 8	7/8	7/8	7/8	7/8
10 – 16	7/8	7/8	7/8	1 1/8



B HORIZONTAL FAN COIL UNITS • DUCTED



## Model Series 35FH • Direct Drive Draw-through • EPIC ECM, 3-Speed ECM and PSC Motor • 2-pipe with Electric Heat • Sizes 18 – 24

### MODEL:

**35FHZE** Chilled/Hot water (2-pipe) with Electric Heat.

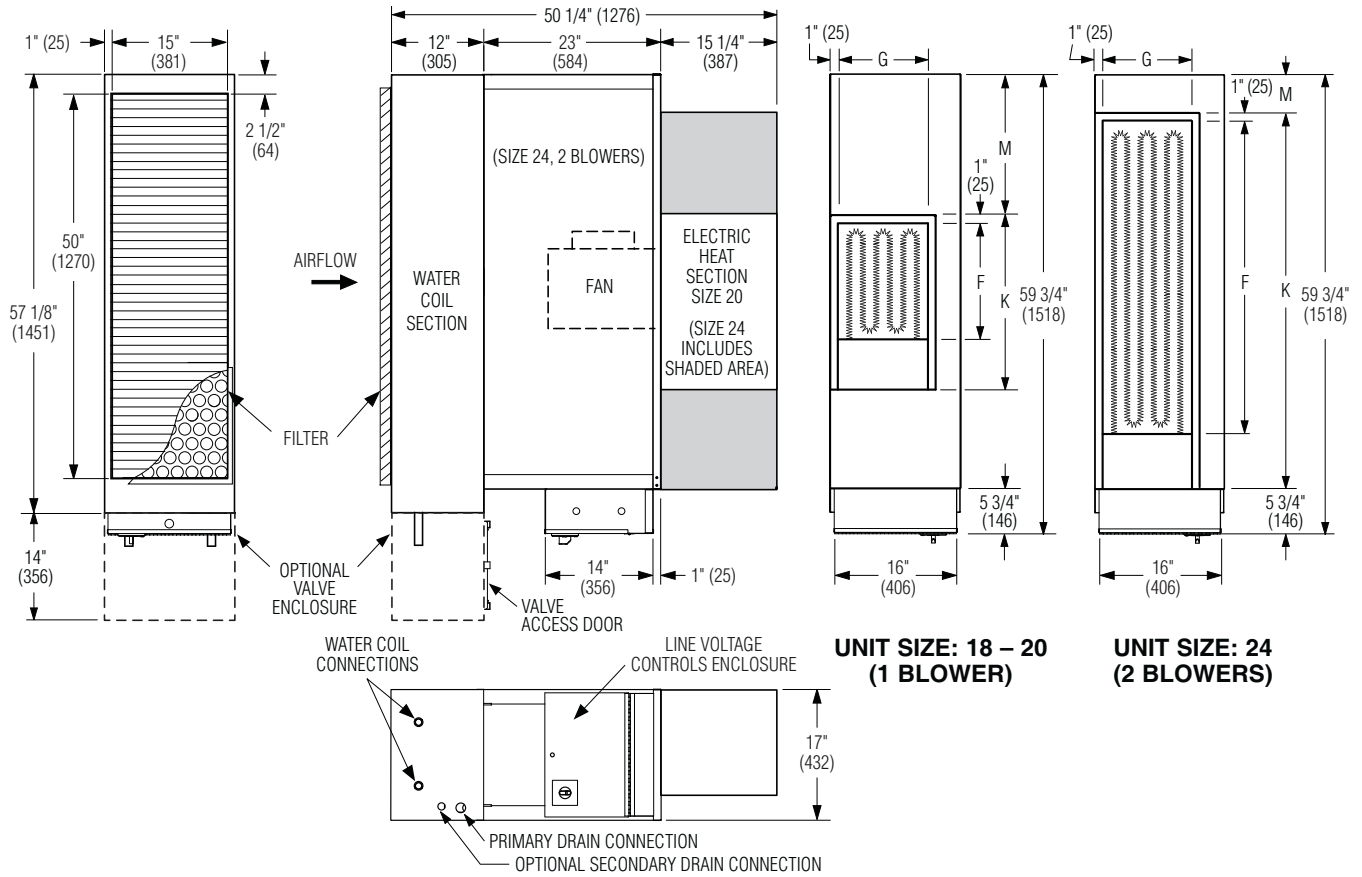

**B** HORIZONTAL FAN COIL UNITS • DUCTED

### Dimensional Data

Unit Size	Nominal CFM (l/s)	Outlet Duct Size F x G	K	M	Filter Size W x H
18	1800 (849)	15 1/4 x 11 3/4 (387 x 298)	23 (584)	18 3/8 (467)	52 x 16 (1321 x 406)
20	2000 (944)	15 1/4 x 11 3/4 (387 x 298)	23 (584)	18 3/8 (467)	
24	2400 (1038)	41 1/4 x 11 3/4 (1048 x 298)	49 (1245)	5 (127)	



### Coil O.D. Sweat Connections

Unit Size	Number of Rows			
	3	4	5	6
18 – 24	1 1/8	1 1/8	1 1/8	1 1/8

## Model Series 35FH • Direct Drive Draw-through • EPIC ECM, 3-Speed ECM and PSC Motor • 2-pipe with Electric Heat • Sizes 30 and 40

### MODEL:

**35FHZE** Chilled/Hot water (2-pipe) with Electric Heat.

**B**

**HORIZONTAL FAN COIL UNITS • DUCTED**

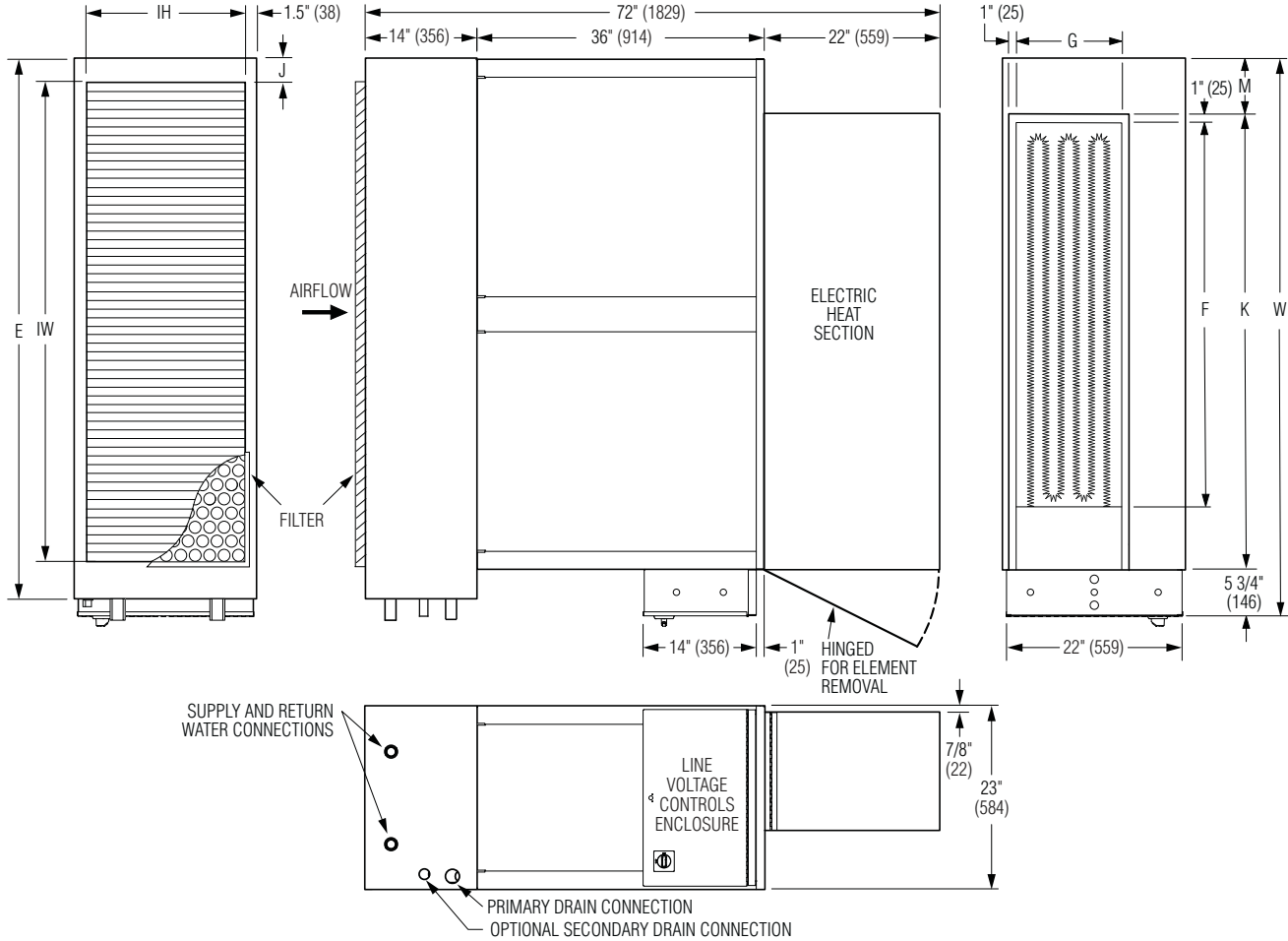

### Dimensional Data

Unit Size	Nominal CFM (l/s)	E	J	Inlet IW x IH	Outlet Duct Size F x G	K	M	W	Filter Size W x H
30	3000(1416)	57 1/8 (1451)	2 3/8 (60)	50 x 20 (1270 x 508)	41 1/2 x 12 (1054 x 305)	49 (1245)	5 (127)	59 3/4 (1518)	52 x 22 (1321 x 559)
40	4000 (1888)	67 5/8 (1718)	2 7/8 (73)	60 x 20 (1524 x 508)	48 1/2 x 13 1/2 (1232 x 343)	57 (1448)	7 (178)	69 3/4 (1772)	62 x 22 (1575 x 559)

### Coil O.D. Sweat Connections

Unit Size	Number of Rows			
	3	4	5	6
30 & 40	1 3/8	1 3/8	1 3/8	1 3/8



## Model Series 35FH • Direct Drive Draw-through • EPIC ECM, 3-Speed ECM and PSC Motor • Electric Heat Only • Sizes 8 and 16

**MODEL:**

**35FHE** Electric Heat Only.

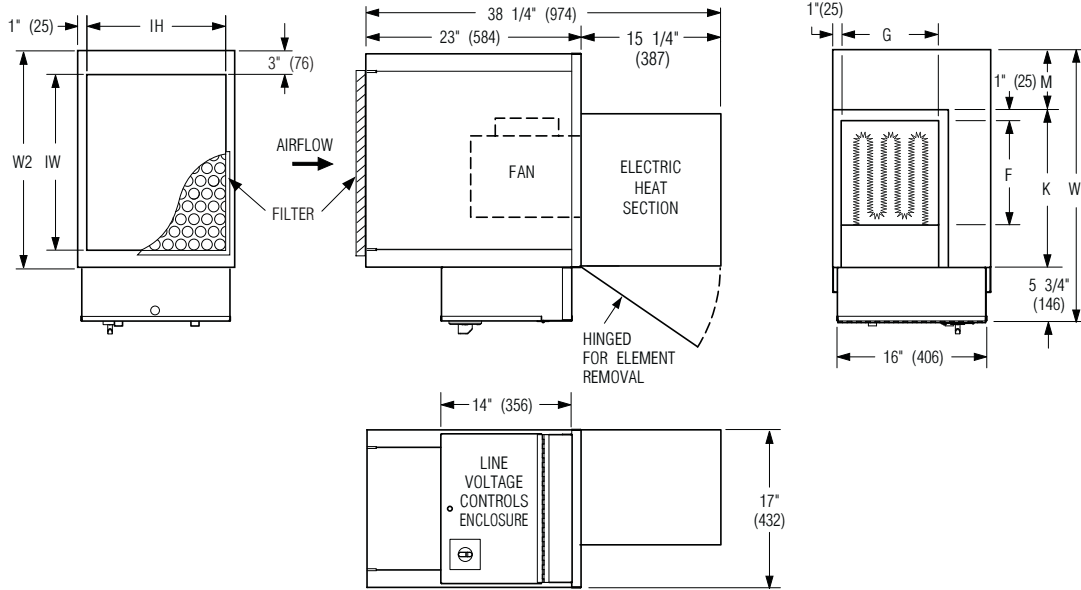

**Dimensional Data**

Unit Size	Nominal CFM (l/s)	W	W2	Inlet IW x IH	Outlet Duct Size F x G	K	M	Filter Size W x H
8	800 (378)	28 3/4 (730)	23 (584)	19 x 15 (483 x 381)	11 1/4 x 10 1/2 (286 x 267)	16 1/2 (419)	6 1/2 (165)	20 x 16 (508 x 406)
16	1600 (755)	42 3/4 (1086)	37 (940)	33 x 15 (838 x 381)	15 1/8 x 11 3/4 (384 x 298)	23 (584)	14 (356)	35 x 16 (889 x 406)



**B** HORIZONTAL FAN COIL UNITS • DUCTED

# HORIZONTAL HIGH CAPACITY FAN COIL UNITS • DUCTED Engineered Comfort

**Model Series 35FH • Direct Drive Draw-through • EPIC ECM, 3-Speed ECM and PSC Motor • Electric Heat Only • Sizes 20 and 24**

**MODEL:**  
35FHE Electric Heat Only.

**B** HORIZONTAL FAN COIL UNITS • DUCTED

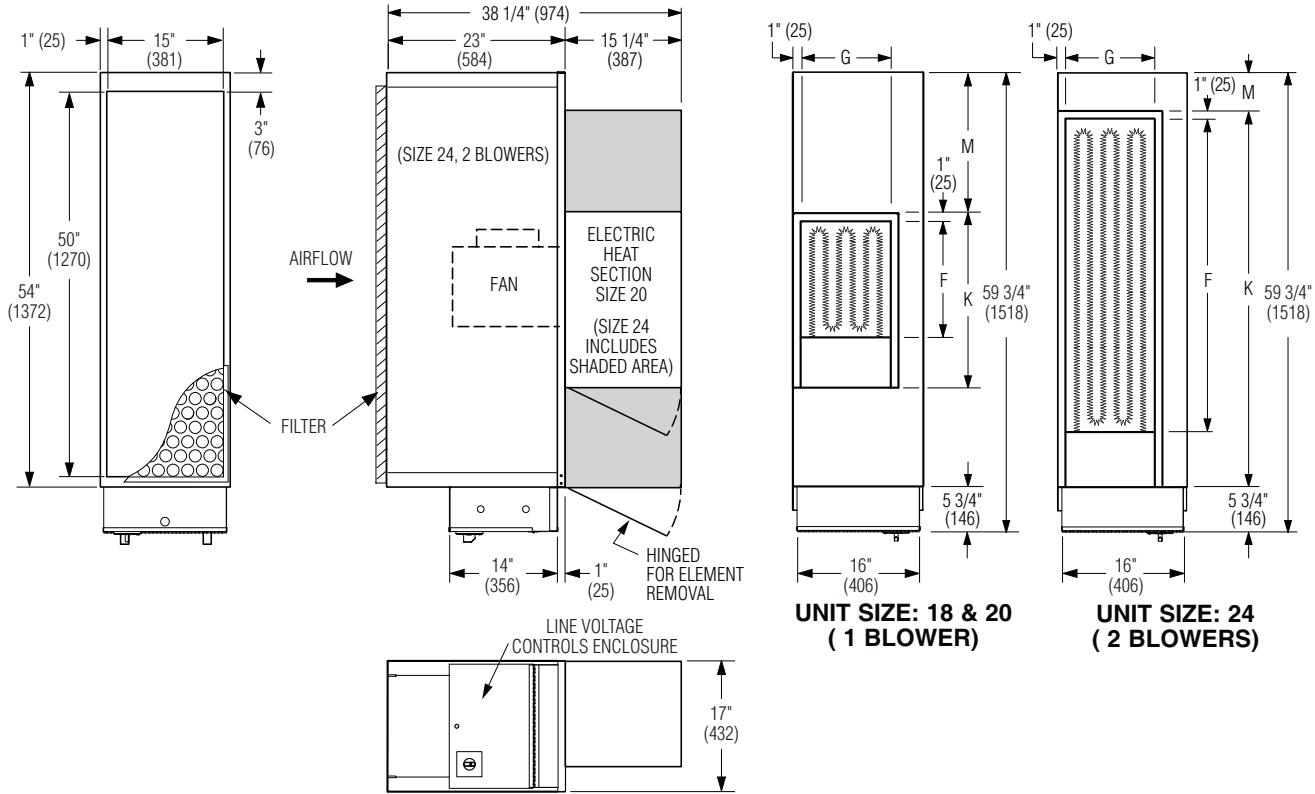

**Dimensional Data**

Unit Size	Nominal CFM (l/s)	Outlet Duct Size F x G	K	M	Filter Size W x H
20	2000 (944)	15 1/4 x 11 3/4 (387 x 298)	23 (584)	18 3/8 (467)	52 x 16 (1321 x 406)
24	2400 (1133)	41 1/4 x 11 3/4 (1048 x 298)	49 (1245)	5 (127)	52 x 16 (1321 x 406)



## Model Series 35FH • Direct Drive Draw-through • EPIC ECM, 3-Speed ECM and PSC Motor • Electric Heat Only • Sizes 30 and 40

**MODEL:**

**35FHE** Electric Heat Only.

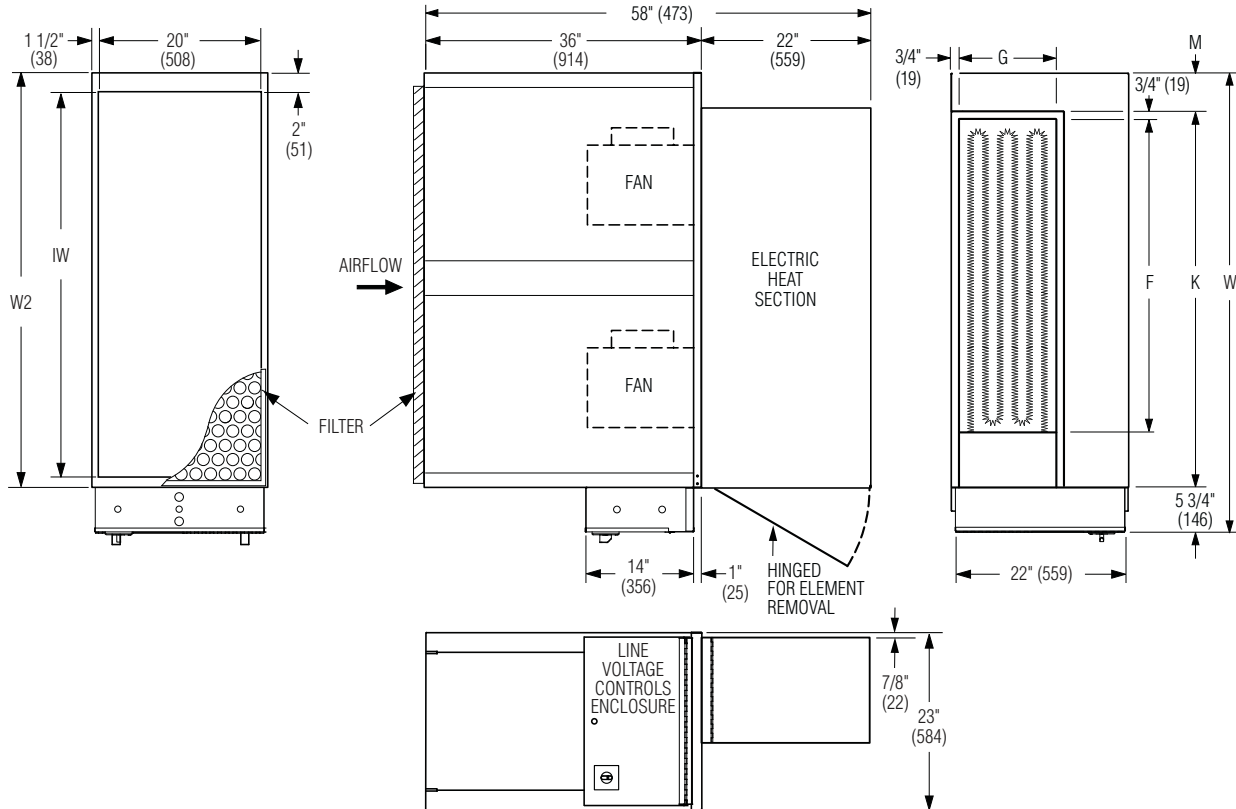

**B** HORIZONTAL FAN COIL UNITS • DUCTED

**Dimensional Data**

Unit Size	Nominal CFM (l/s)	Outlet Duct Size F x G	K	M	W2	IW	W	Filter Size W x H
30	3000 (1416)	41 1/2 x 12 (1054 x 305)	49 (1245)	5 (127)	54 (1372)	50 (1270)	59 3/4 (1518)	52 x 22 (1321 x 559)
40	4000 (1888)	48 1/2 x 13 1/2 (1232 x 343)	57 (1448)	7 (178)	64 (1626)	60 (1524)	67 3/4 (1772)	62 x 22 (1575 x 559)



## Model Series 35FH • Outside Air Inlet (OAI) Option Unit Sizes 4 – 40

### MODELS:

- 35FHZ** Chilled/Hot Water (2-pipe).
- 35FHZW** Chilled & Hot Water (4-pipe).
- 35FHW** Hot Water Only (2-pipe).
- 35FHZE** Chilled/Hot Water (2-pipe) with Electric Heat.

### Standard Construction (OAI Inlet):

1. Casing: 20 ga. (1.00), corrosion-resistant steel with stiffening beads.
2. Blade: Two layers of 20 ga. (1.00), corrosion-resistant steel laminated together with a cross-linked polyethylene peripheral gasket for tight shut-off. 90° rotation, CW to close. Damper leakage is less the 1% of the terminal rated airflow at 3" w.g. (750 pa.) and less than 2% at 6" w.g. (1500 pa.) as tested in accordance with ANSI / ASHRAE Standard 130.
3. Bearings: Self-lubricating oilite bronze.
4. Drive Shaft/Axles: 1/2" (13) diameter plated steel, double-bolted to blades. Indicator mark on the end of the shaft to show damper position.
5. Multi-point averaging Diamond Flow Sensor: Aluminum construction. Supplied with brass balancing tees. See EC-IOM-FCK for associated K-factor(s).

### OPTIONS:

- Full NEMA 1 type controls enclosure for field mounted controllers/actuators.
- Optional valve enclosure for unit sizes 4 – 24.

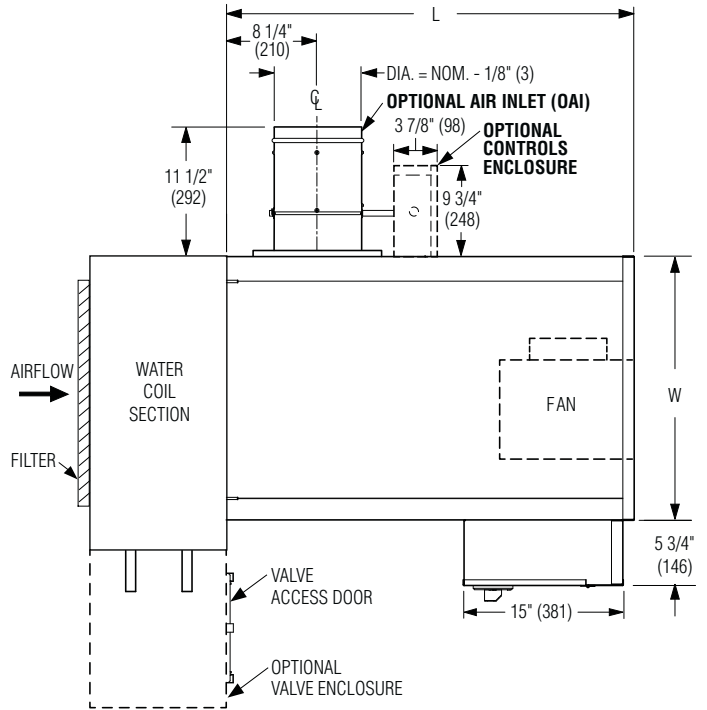

### Dimensional Data

Unit Size	Nominal CFM (l/s)	Available Outside Air Inlet (OAI) Dia.	W	L
4	400 (189)	4, 5, 6 (102, 127, 152)	23 (584)	36 (914)
6	600 (283)		23 (584)	
8	800 (378)		23 (584)	
10	1000 (472)	37 (940)		
12	1200 (566)	4, 5, 6, 8 (102, 127, 152, 203)	37 (940)	
14	1400 (661)		37 (940)	
16	1600 (755)	4, 5, 6, 8, 10 (102, 127, 152, 203, 254)	37 (940)	
18	1800 (849)		54 (1372)	
20	2000 (944)		54 (1372)	
24	2400 (1038)		54 (1372)	
30	3000 (1416)	4, 5, 6, 8, 10, 12 (102, 127, 152, 203, 254, 305)	54 (1372)	
40	4000 (1888)		64 (1626)	



## Model Series 35FH • Filter Rack Option • Options and Accessories

### DESCRIPTION:

- The FFR Ducted Return Filter Rack Connection is an optional accessory for the Horizontal Fan Coil Units Model Series 35FH and 37FH.
- The accessory is required for ducted inlet applications where a filter is also required and ease of accessibility is required.
- The Ducted Filter Connection features a filter rack, which accommodates a 1" (25) standard or 2" (51) optional filter.
- Factory mounted on the induced air inlet of the draw-through water coil section.
- A piano-hinged door flap with latch on the side and bottom of the unit accessory allows for easy removal and replacement of the filter.
- The accessory is provided with a nominally sized duct connection collar.
- Side access to filter is same as coil hand.

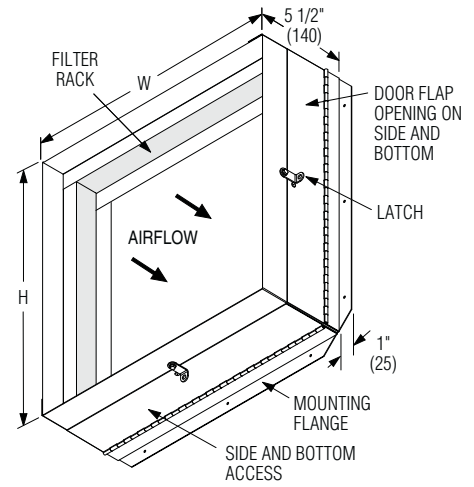

### Dimensional Data

Unit Size	Inlet Size W x H	Filter Size W x H (Nominal)
4, 6, 8	16 1/2 x 20 1/4 (419 x 514)	20 x 16 (508 x 406)
10, 12, 14, 16	16 1/2 x 35 1/4 (419 x 895)	35 x 16 (889 x 406)
18, 20, 24	16 1/2 x 52 1/4 (419 x 1327)	52 x 16 (1321 x 406)

## Model Series 35FH • Mixing Box • Options and Accessories

### MODELS:

**MBBR** Bottom and Rear Return Dampers.

**MBTR** Top and Rear Return Dampers.

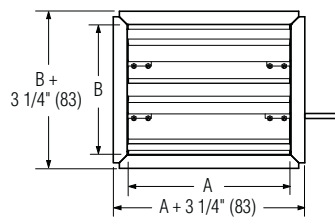
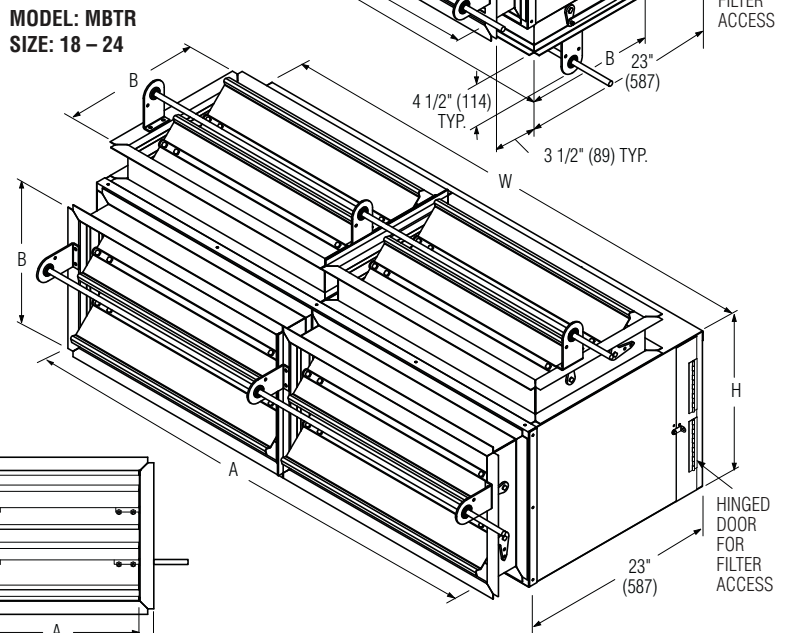
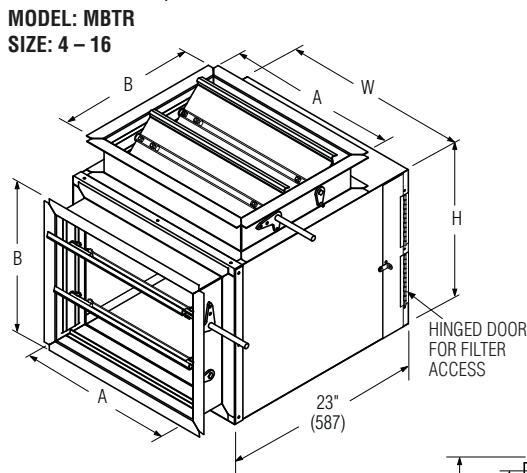
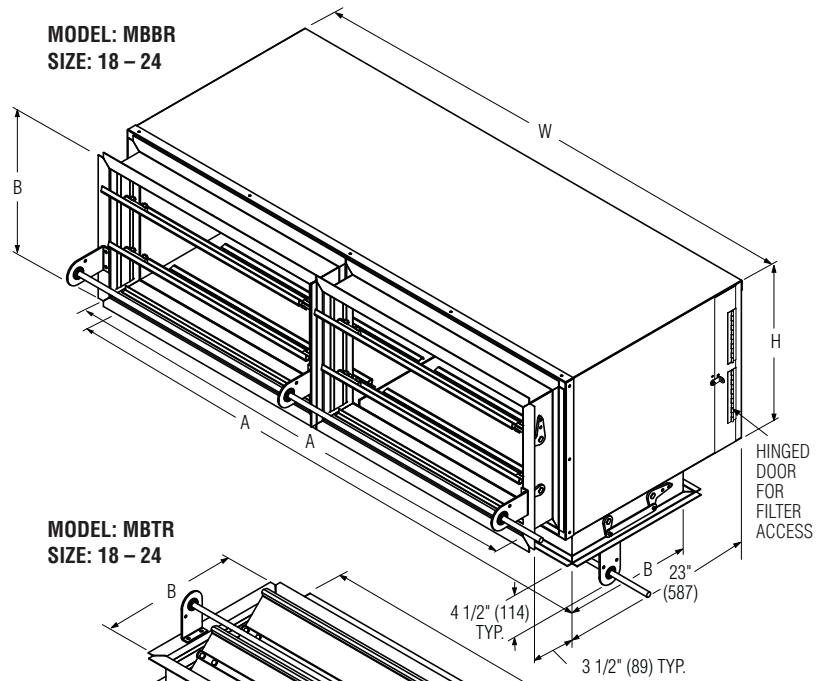
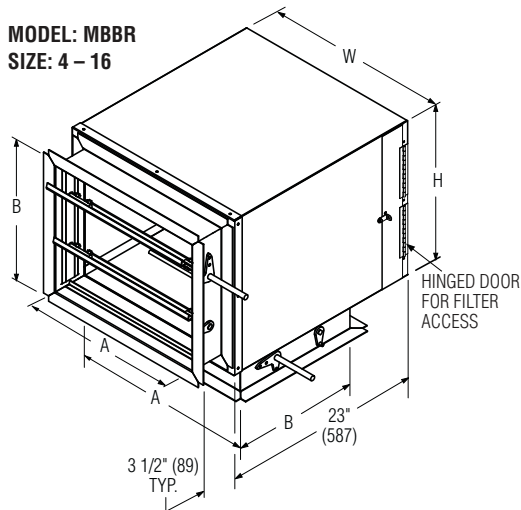

The fully insulated mixing box with filter rack and heavy duty dampers provides a mixing capability for control of return air and outside air for economizer operation.

### STANDARD FEATURES:

- 18 ga. (1.31) galvanized steel casing.
- 3/4" (19) dual density insulation, exposed edges coated to prevent air erosion. Meets the requirements of NFPA 90A and UL 181.
- Low leakage parallel control dampers with blade and jamb seals.
- Filter rack to accommodate a 1" (25) standard or 2" (51)
- A piano-hinged door flap with latch on the side and bottom of the mixing box allows for easy removal and replacement of filter.

### Dimensional Data

Unit Size	A	B	W	H
4, 6, 8	19 (483)	13 3/4 (349)	22 1/4 (565)	17 (432)
10, 12, 14, 16	33 (838)	13 3/4 (349)	36 1/4 (921)	17 (432)
18, 20, 24	50 (1270)	13 3/4 (349)	54 1/4 (1388)	17 (432)

- 1 5/8" (41) flange on dampers for a flanged duct connection.
- 1/2" (13) dia. driveshaft.
- Crank-arms, swivels and linkage rod provided for damper inter-connection.
- Actuator and controls by others.
- Assembly ships loose.

## Model Series 35FH • PSC Motor • Fan Performance Curves

### Airflow vs. External Static Pressure

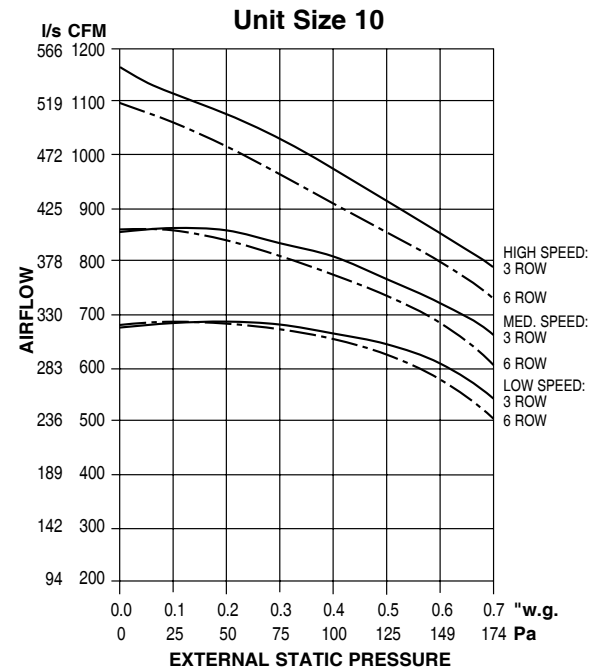
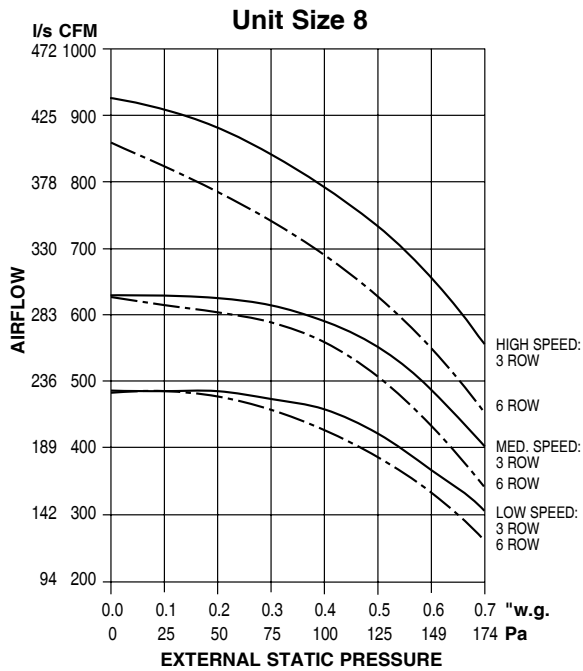
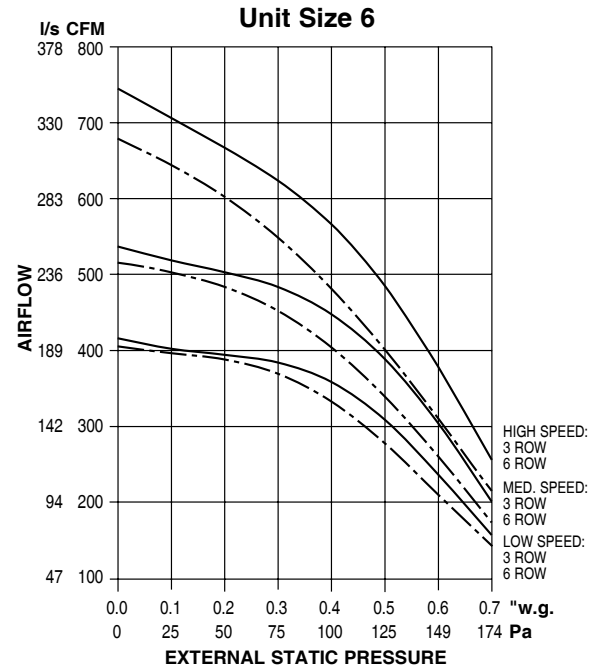
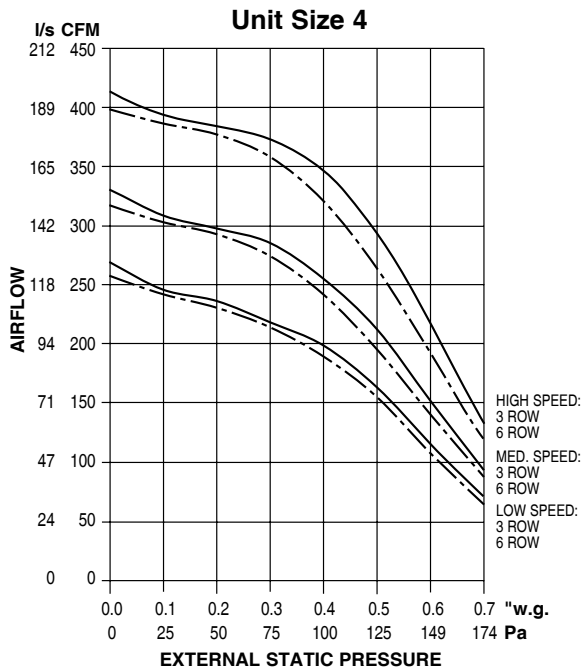

#### PSC Motor Fan Notes:

1. Permanent split capacitor (PSC) motors are of the three speed type with separate taps (High, Medium and Low) which provide variable horsepower outputs. Commonly, units are selected and sized on a conservative basis and actual airflow and/or external static pressure requirements are lower than specified. When this is the case, the unit fan motor can be run at low or medium speed, reducing power consumption and operating cost.
2. All fan curves shown are for 277 volt single phase PSC motors and include internal losses for cabinet, electric heater and 3 or 6 row water coil.
3. For other coil combinations and type of filters, adjust performance curves based on pressure losses or use Selectworks.
4. Filter pressure drops table shown on page B28.

## Model Series 35FH • PSC Motor • Fan Performance Curves

### Airflow vs. External Static Pressure

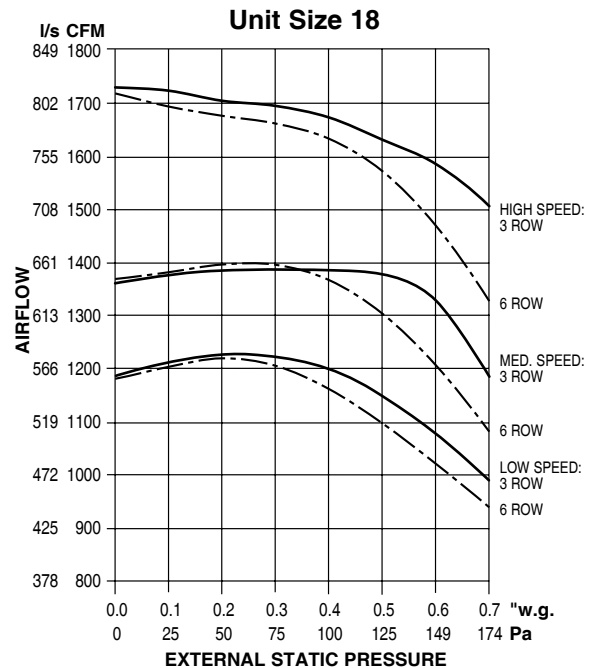
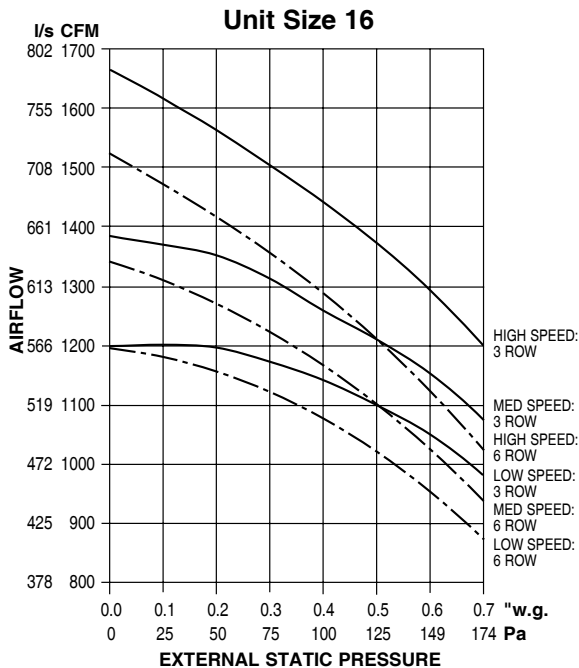
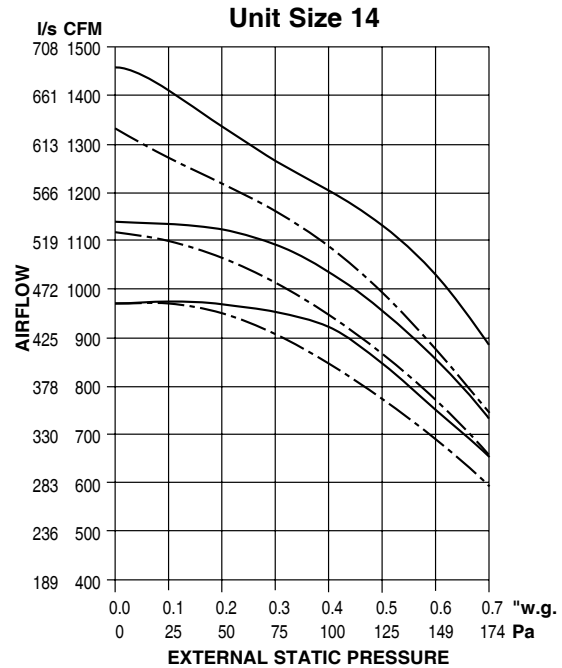
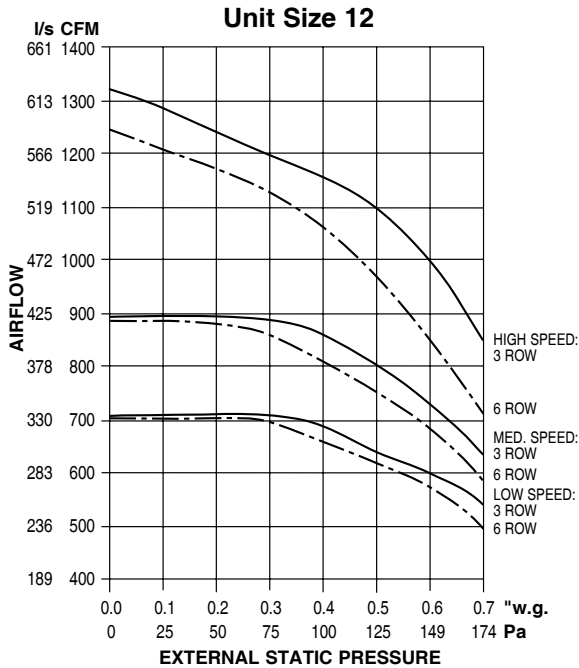

#### PSC Motor Fan Notes:

1. Permanent split capacitor (PSC) motors are of the three speed type with separate taps (High, Medium and Low) which provide variable horsepower outputs. Commonly, units are selected and sized on a conservative basis and actual airflow and/or external static pressure requirements are lower than specified. When this is the case, the unit fan motor can be run at low or medium speed, reducing power consumption and operating cost.
2. All fan curves shown are for 277 volt single phase PSC motors and include internal losses for cabinet, electric heater and 3 or 6 row water coil.
3. For other coil combinations and type of filters, adjust performance curves based on pressure losses or use Selectworks.
4. Filter pressure drops table shown on page B28.

B

HORIZONTAL FAN COIL UNITS • DUCTED

## Model Series 35FH • PSC Motor • Fan Performance Curves

### Airflow vs. External Static Pressure

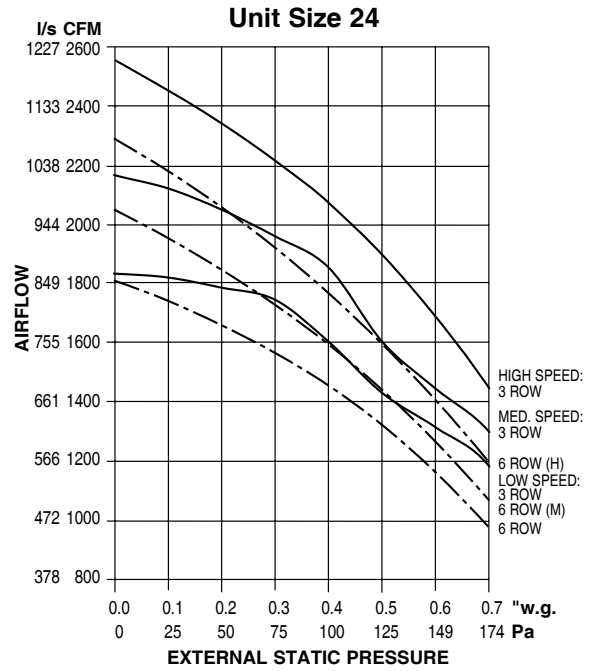
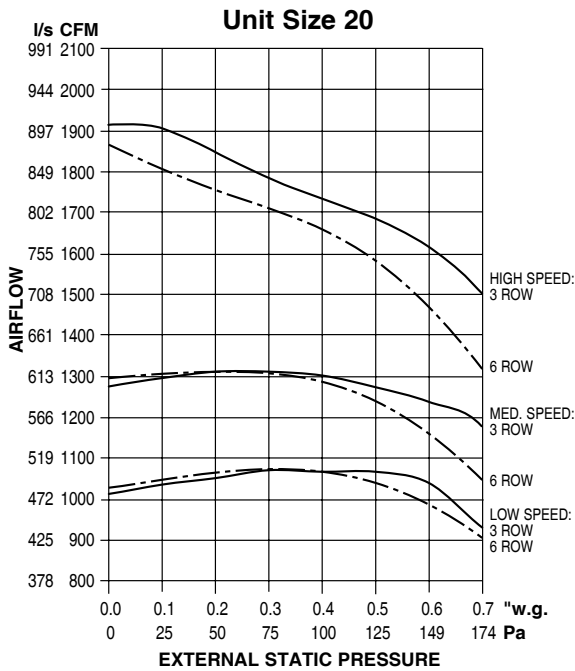

#### PSC Motor Fan Notes:

1. Permanent split capacitor (PSC) motors are of the three speed type with separate taps (High, Medium and Low) which provide variable horsepower outputs. Commonly, units are selected and sized on a conservative basis and actual airflow and/or external static pressure requirements are lower than specified. When this is the case, the unit fan motor can be run at low or medium speed, reducing power consumption and operating cost.
2. All fan curves shown are for 277 volt single phase PSC motors and include internal losses for cabinet, electric heater and 3 or 6 row water coil.
3. For other coil combinations and type of filters, adjust performance curves based on pressure losses or use Selectworks.
4. Filter pressure drops table shown on page B28.

## Model Series 35FH • 3-Speed ECM Fan Performance Curves

### Airflow vs. External Static Pressure

B

HORIZONTAL FAN COIL UNITS • DUCTED

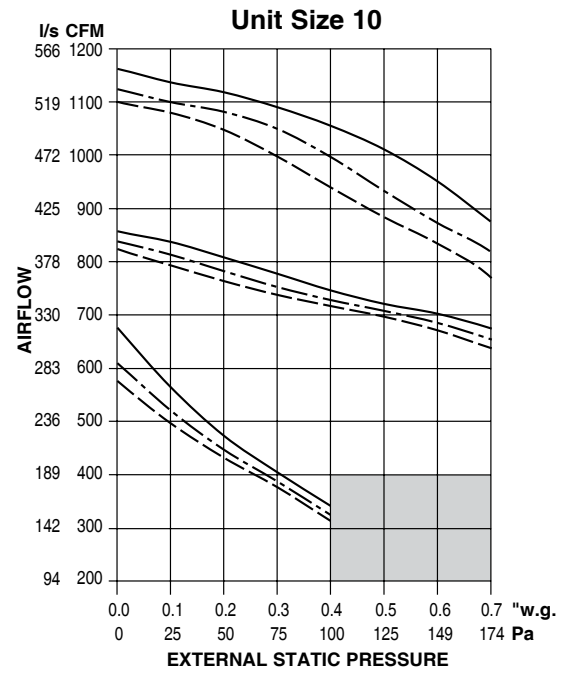
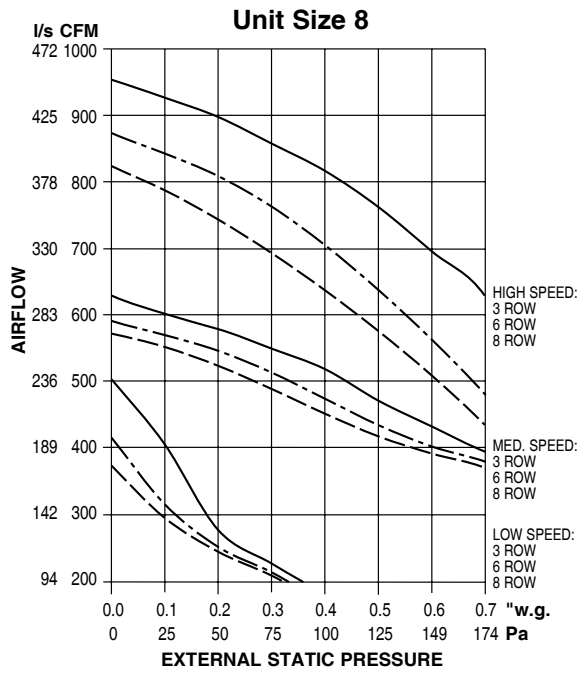
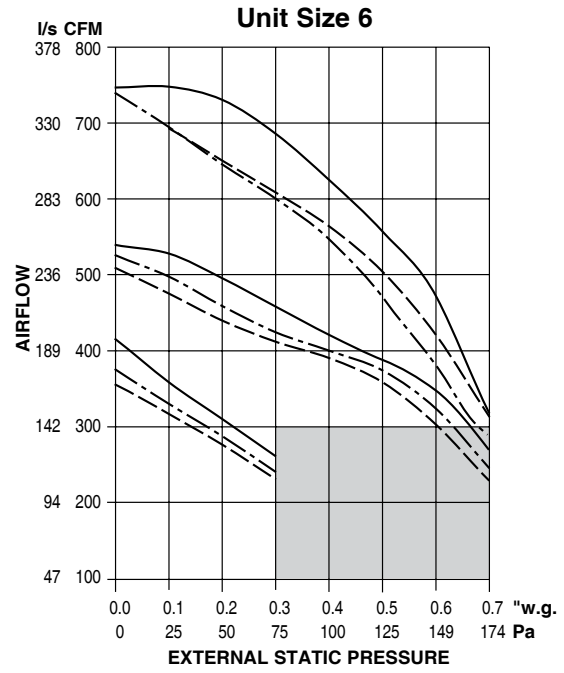
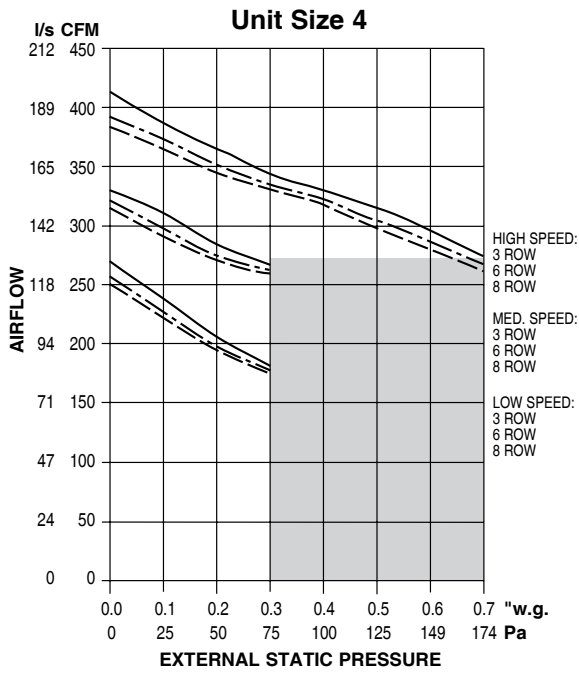

### 3-Speed ECM Motor Fan Notes:

1. Fan coil units equipped with 3-Speed ECM Motors have separate taps (High, Medium and Low) which provide variable horsepower outputs. Commonly, units are selected and sized on a conservative basis and actual airflow and/or external static pressure requirements are lower than specified. When this is the case, the unit fan motor can be run at low or medium speed, reducing power consumption and operating cost.
2. All fan curves shown are for 277 volt single phase 3-Speed ECM Motors and include internal losses for cabinet, electric heater and 3, 6 or 8 row water coil.
3. For other coil combinations and type of filters, adjust performance curves based on pressure losses or use Selectworks.
4. Operation within shaded area not predictable.
5. Filter pressure drops table shown on page B28.



## Model Series 35FH • 3-Speed ECM • Fan Performance Curves

### Airflow vs. External Static Pressure

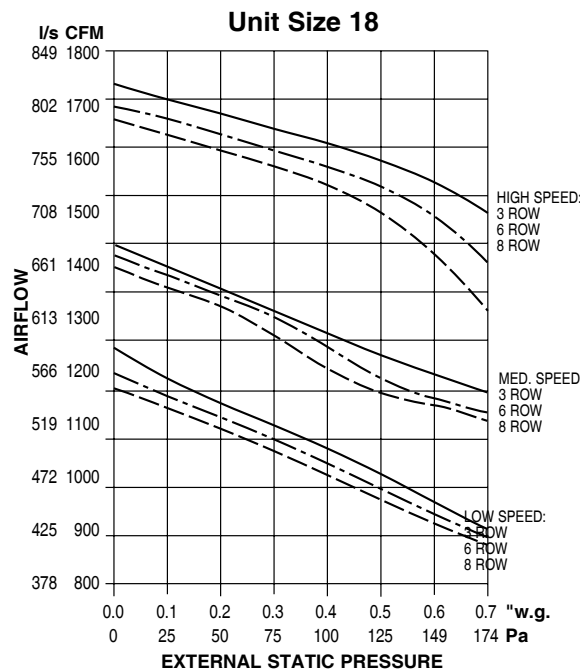
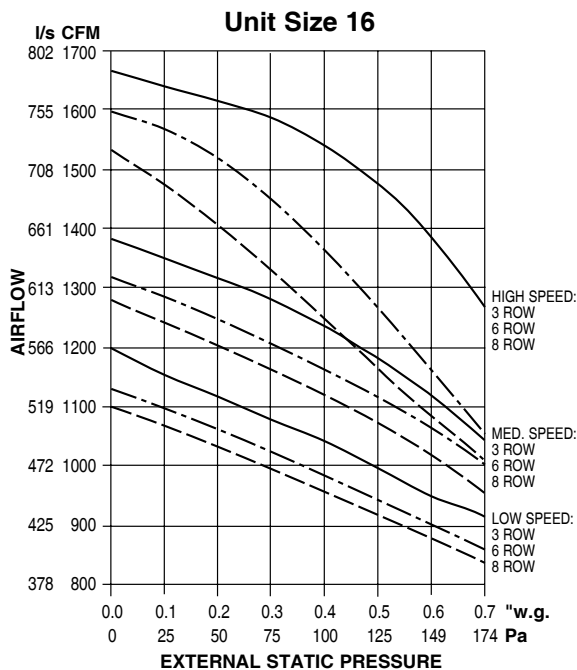
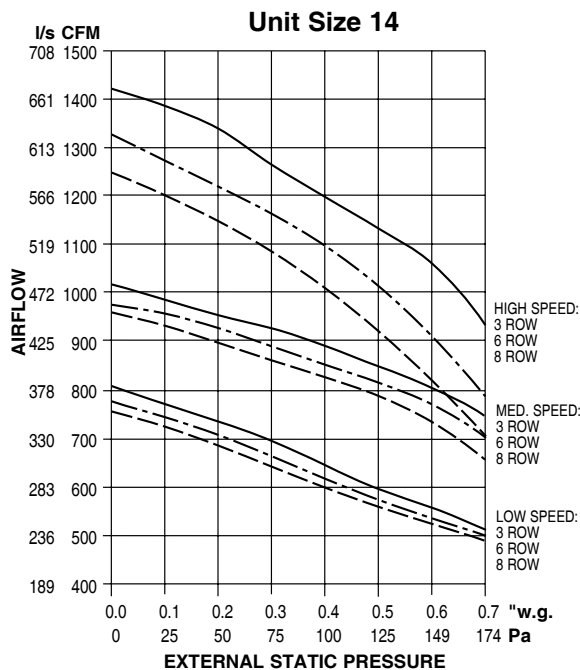
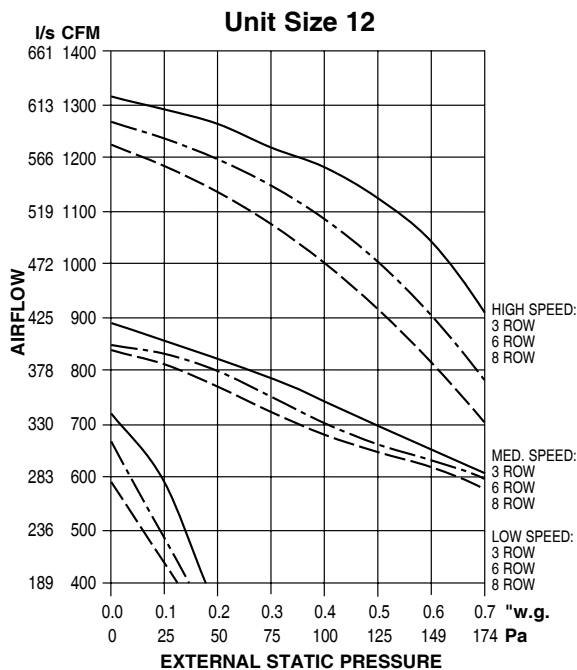

#### 3-Speed ECM Motor Fan Notes:

1. Fan coil units equipped with 3-Speed ECM Motors have separate taps (High, Medium and Low) which provide variable horsepower outputs. Commonly, units are selected and sized on a conservative basis and actual airflow and/or external static pressure requirements are lower than specified. When this is the case, the unit fan motor can be run at low or medium speed, reducing power consumption and operating cost.
2. All fan curves shown are for 277 volt single phase 3-Speed ECM Motors and include internal losses for cabinet, electric heater and 3, 6 or 8 row water coil.
3. For other coil combinations and type of filters, adjust performance curves based on pressure losses or use Selectworks.
4. Filter pressure drops table shown on page B28.

## Model Series 35FH • 3-Speed ECM • Fan Performance Curves

### Airflow vs. External Static Pressure

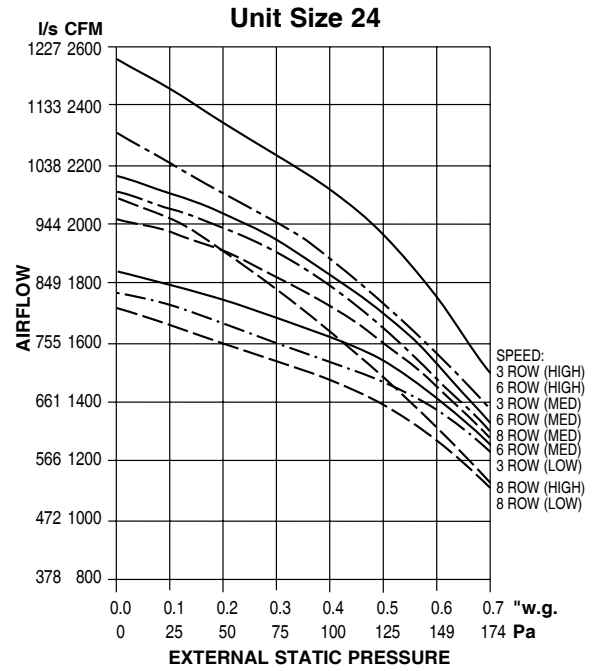
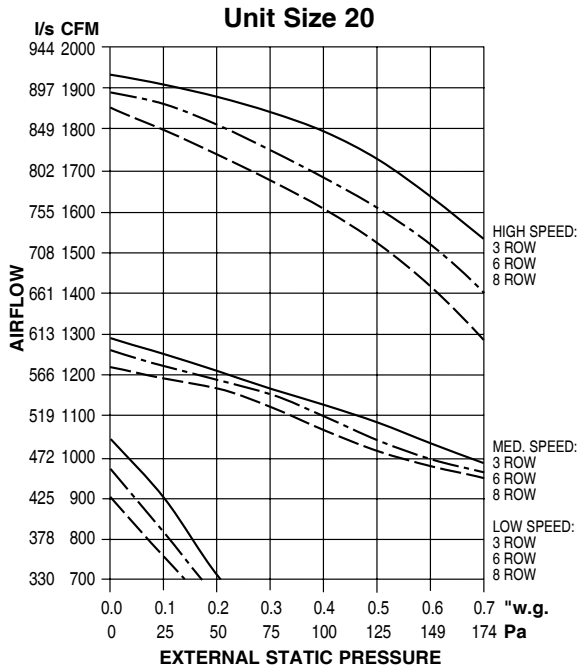

### 3-Speed ECM Motor Fan Notes:

1. Fan coil units equipped with 3-Speed ECM motors have separate taps (High, Medium and Low) which provide variable horsepower outputs. Commonly, units are selected and sized on a conservative basis and actual airflow and/or external static pressure requirements are lower than specified. When this is the case, the unit fan motor can be run at low or medium speed, reducing power consumption and operating cost.
2. All fan curves shown are for 277 volt single phase 3-Speed ECM motors and include internal losses for cabinet, electric heater and 3, 6 or 8 row water coil.
3. For other coil combinations and type of filters, adjust performance curves based on pressure losses or use Selectworks.
4. Filter pressure drops table shown on page B28.

B

HORIZONTAL FAN COIL UNITS • DUCTED

## Model Series 35FH • EPIC ECM Motor • Fan Performance Curves

### Airflow vs. External Static Pressure

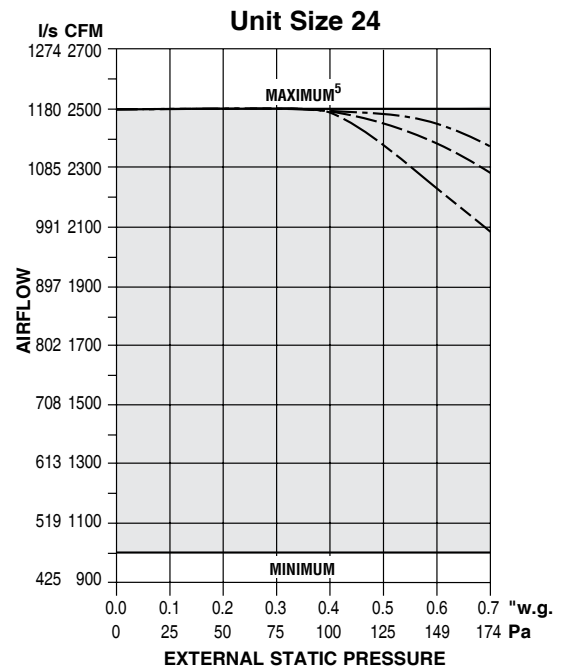
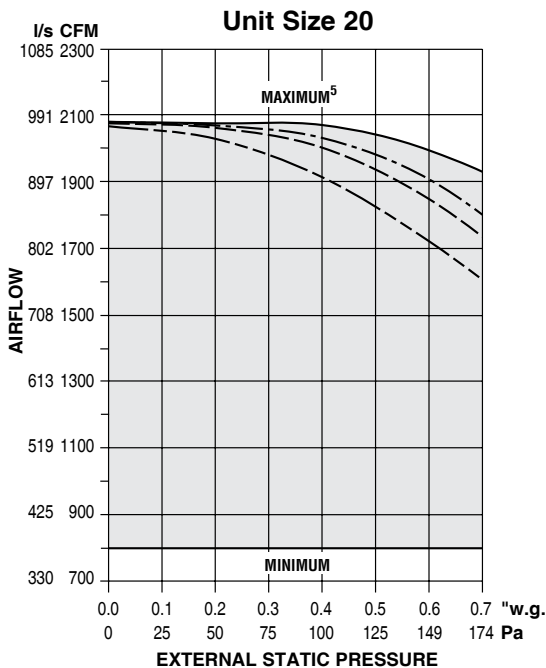
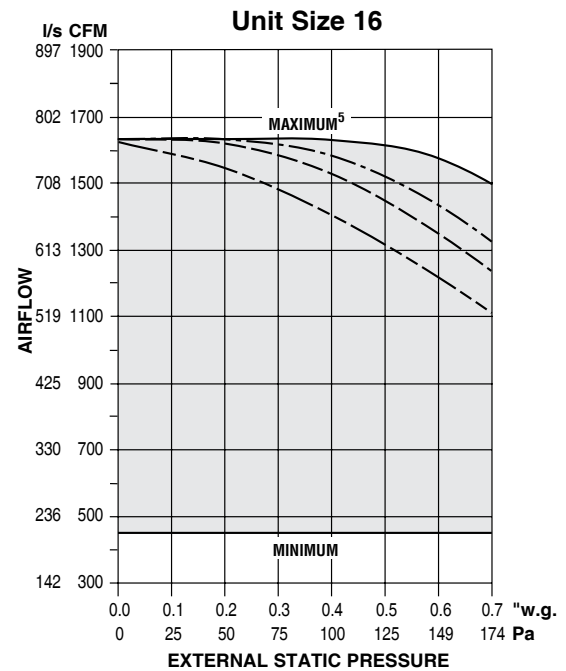
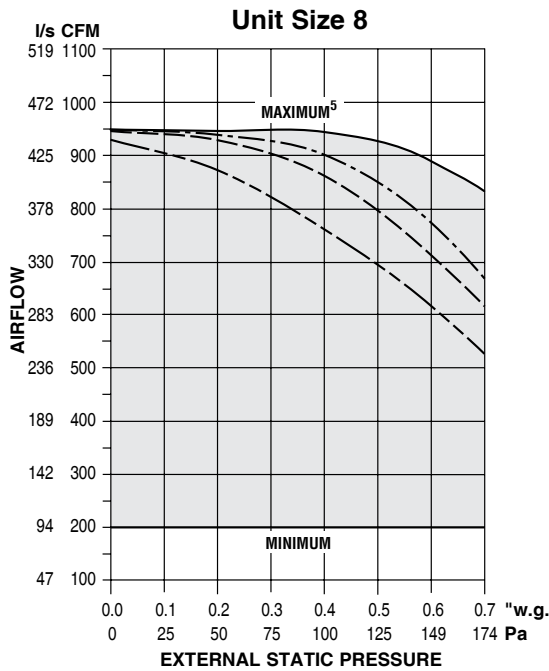

#### EPIC ECM Notes:

1. The EPIC ECM is a pressure independent constant volume device at set point and airflow does not vary with changing static pressure condition. The motor compensates for any changes in static pressure such as filter loading. Variations in airflow are generated by the controls which reset the fan airflow based on room demand. (See control sequence).
2. Airflow can be set to operate at any point within shaded area under the selected water coil curve using the EPIC volume controller provided.
3. Engineered Comfort Fan Coil units featuring the optional EPIC ECM have considerably wider turn-down ratios than conventional PSC motors. Hence, a reduced number of unit sizes will provide the same fan airflow range when compared

with fan coils equipped with PSC motors. A reduction in the number of different fan coil sizes, required on a typical project, simplifies design lay-out, installation and reduces inventory of field service parts.

4. Fan curves shown are applicable to 120/208/240 and 277 volt, single phase EPIC ECM (motors).
5. The maximum curve represents unit performance with a 3-row coil. For one (1) or two (2) row hot water coils (35FHW heating unit) performance will be slightly better. Model 35FHE (electric heat only) performance data will be comparable to a one (1) row unit. See SelectWorks for performance data Characteristics.
6. Filter pressure drops table shown on page B28.

## Model Series 35FH • EPIC ECM Motor • Fan Performance Curves

### Airflow vs. External Static Pressure

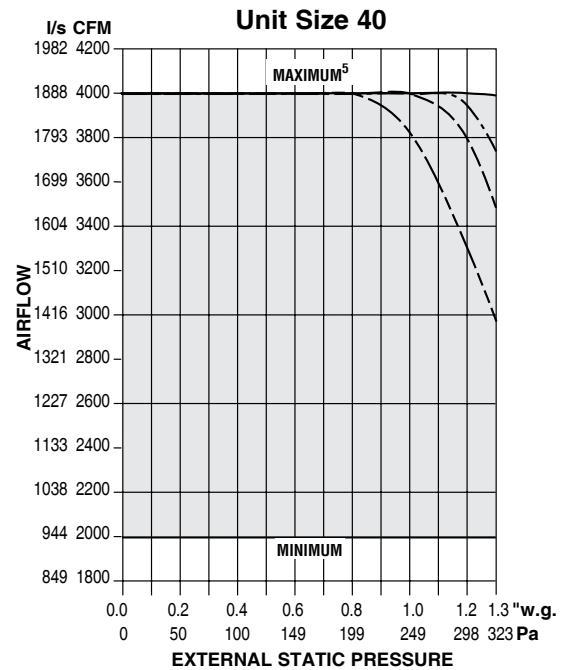
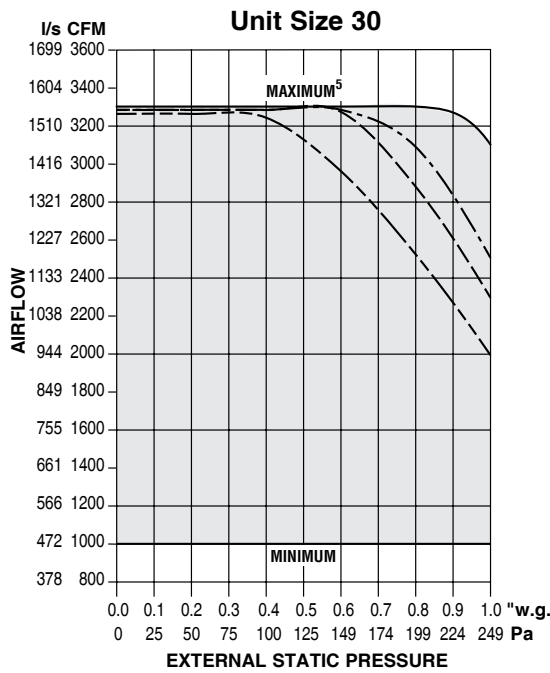

#### EPIC ECM Notes:

1. The EPIC ECM is a pressure independent constant volume device at set point and airflow does not vary with changing static pressure condition. The motor compensates for any changes in static pressure such as filter loading. Variations in airflow are generated by the controls which reset the fan airflow based on room demand. (See control sequence).
2. Airflow can be set to operate at any point within shaded area under the selected water coil curve using the EPIC volume controller provided.
3. Engineered Comfort Fan Coil units featuring the optional EPIC ECM have considerably wider turn-down ratios than conventional PSC motors. Hence, a reduced number of unit sizes will provide the same fan airflow range when compared

with fan coils equipped with PSC motors. A reduction in the number of different fan coil sizes, required on a typical project, simplifies design lay-out, installation and reduces inventory of field service parts.

4. Fan curves shown are applicable to 120/208/240 and 277 volt, single phase EPIC ECM (motors).
5. The maximum curve represents unit performance with a 3-row coil. For one (1) or two (2) row hot water coils (35FHW heating unit) performance will be slightly better. Model 35FHE (electric heat only) performance data will be comparable to a one (1) row unit. See SelectWorks for performance data Characteristics.
6. Filter pressure drops table shown on page B28.

## Model Series 35FH Performance Data • Electric Heat

### ELECTRIC HEATER

Electric heat coils are available as a factory mounted on the unit discharge. Nailor Electric Coils are tested with the fan terminal in accordance with CSA 236/UL 1995 and meet all the requirements of the NEC. Units and heaters are listed and labeled by the ETL testing Laboratory as an integrated package. A NEMA 1 enclosure with hinges is placed at the side of the fan coil to provide easy access. All motor and heater wiring terminates in the enclosure for single point electrical connection.

### STANDARD FEATURES

- Automatic reset high limit thermal cut-outs
- Magnetic contactors per stage with DDC or electronic controls
- Control voltage transformer (Class 2) for DDC and electronic controls
- Class A 80/20 Ni/Cr wire.

### OPTIONS

- Toggle Disconnect
- Door Interlocking disconnect switch
- Quiet contactors
- Power circuit fusing
- Dust tight control enclosure
- Manual reset secondary high limit
- Airflow Safety Switch, electronic interlock (on EPIC ECM only) or mechanical
- 1 or 2 Stage Electric Heat
- SCR Control for quieter and variable wattage

### SCR Control Option

The SCR (Silicon Controlled Rectifier) option provides infinite heater control using a proportional control. In addition to superior comfort and energy savings, contactor noise is eliminated and life of the electric heater element is extended. This option is normally specified with all DDC controls. SSR with 4-20 ma 0-10 Vdc control.

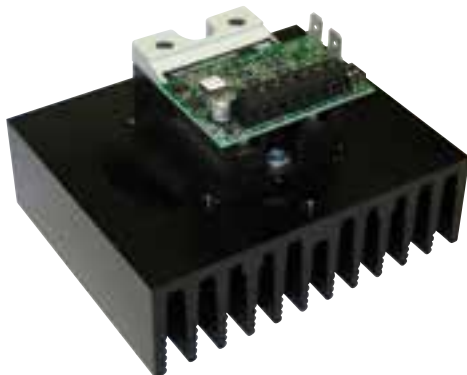

**SCR (Silicon Controlled Rectifier)**



### Electric Heat Selection Tables:

Conventional Staged Heat: 1 or 2 Stage available

Unit Size	1 phase Voltage (Min. – Max.) kW				3 phase Voltage	
	115V	208V	230V	277V	208V	480V
4	1.0 – 2.5				1.0 – 2.5	
6	1.0 – 4.5				1.0 – 4.5	
8	1.0 – 5.0				1.0 – 5.0	
10	2.0 – 4.5	2.0 – 8.5			2.0 – 8.5	
12	2.0 – 4.5	2.0 – 9.0			2.0 – 9.0	
14	2.0 – 4.5	2.0 – 8.5	2.0 – 10.0		2.0 – 10.0	
16	2.0 – 4.5	2.0 – 8.5	2.0 – 9.5	2.0 – 11.0	2.0 – 11.0	
18	2.0 – 4.5	2.0 – 8.5	2.0 – 9.5	2.0 – 11.5	2.0 – 12.0	
20	2.0 – 4.5	2.0 – 8.5	2.0 – 9.5	2.0 – 11.5	2.0 – 14.0	
24	2.0 – 4.5	2.0 – 8.5	4.0 – 9.5	4.0 – 11.5	4.0 – 13.5	4.0 – 16.0

### SCR Control

Unit Size	1 phase Voltage Maximum kW				3 phase Voltage Maximum kW	
	115V	208V	230V	277V	208V	480V
4	2.5	2.5	2.5	2.5	2.5	2.5
6	3.0	4.5	4.5	4.5	4.5	4.5
8	3.0	5.0	5.0	5.0	5.0	5.0
10	3.0	5.0	5.5	6.5	8.5	8.5
12	3.0	5.0	5.5	6.5	9	9
14	3.0	5.0	5.5	6.5	10	10
16	3.0	5.0	5.5	6.5	9	11
18	3.0	5.0	5.5	6.5	9	12
20	3.0	5.0	5.5	6.5	9	14
24	3.0	5.0	5.5	6.5	9	16

### NOTES:

Minimum kW per Stage = 1kW. For Unit size 4, 6, 8 the total minimum kW per 2 stage E/H is 2kW.

PSC and 3-Speed ECM max. kW's are determined by a combination of testing (at low speed airflow) and 48 amp limits (EH amps plus motor FLA).

The SCR kW's are limited to 25 amps. For higher kW the total amps may be exceeded. Contact your local Nailor representative for supplemental fusing and special sizing.

## Model Series 35FH • Performance Data

### Electrical Motor Characteristics

Unit Size	Voltage	No. of Fans/Motors	EPIC ECM		3-speed ECM		PSC Motor	
			FLA	Full Load Watts	FLA	Full Load Watts	FLA	Full Load Watts
4	120	1/1			1.5	120	1.5	175
	208	1/1			1.4		0.7	
	240	1/1			1.4		0.7	
	277	1/1			0.9		0.6	
6	120	1/1			2.9	220	2.5	280
	208	1/1			1.9		1.1	
	240	1/1			1.9		1.2	
	277	1/1			1.5		1.1	
8	120	1/1	3.3	260	3.3	330	2.7	310
	208	1/1	2.2		2.2			
	240	1/1	2.1		2.2			
	277	1/1	2.1		1.9			
10	120	1/1			3.6	370	3.8	450
	208	1/1			2.4		1.9	
	240	1/1			2.4		1.9	
	277	1/1			2.4		1.5	
12	120	1/1			4.3	430	4.1	500
	208	1/1			2.8		2.0	
	240	1/1			2.7		2.0	
	277	1/1			2.9		1.6	
14	120	1/1			5.1	470	4.6	575
	208	1/1			3.4		2.3	
	240	1/1			3.4		2.3	
	277	1/1			3.2		2.0	
16	120	1/1	7.2	640	6.0	690	7.1	785
	208	1/1	4.9		4.0			
	240	1/1	4.7		4.0			
	277	1/1	4.6		3.7			
18	120	1/1			6.4	700	7.7	830
	208	1/1			4.5		3.3	
	240	1/1			4.5		3.4	
	277	1/1			4.3		3.2	
20	120	1/1	9.6	850	7.7	860	8.2	935
	208	1/1	6.3		5.6			
	240	1/1	6.1		5.6			
	277	1/1	6.0		5.3			
24	120	2/2	11.8	1110	9.4	880	8.3	1000
	208	2/2	7.9		6.0			
	240	2/2	7.8		6.0			
	277	2/2	7.5		6.1			
30	120	2/2	12.6	1260				
	208	2/2	8.7					
	240	2/2	8.4					
	277	2/2	8.0					
40	120	2/2	19.4	1870				
	208	2/2	12.5					
	240	2/2	11.9					
	277	2/2	11.6					

The FLA and watts are shown at the maximum setting for selected motor type and unit size. The EPIC ECM will provide a much lower amp and watt consumption under application conditions. Refer to SelectWorks selection software for application specific data.

**B**

**HORIZONTAL FAN COIL UNITS • DUCTED**



## Model Series 35FH • Energy Consumption Comparison Charts EPIC ECM vs. 3-Speed PSC Motors 3 Row Coil, 0.20" w.g. ESP, 277 Volt Motors

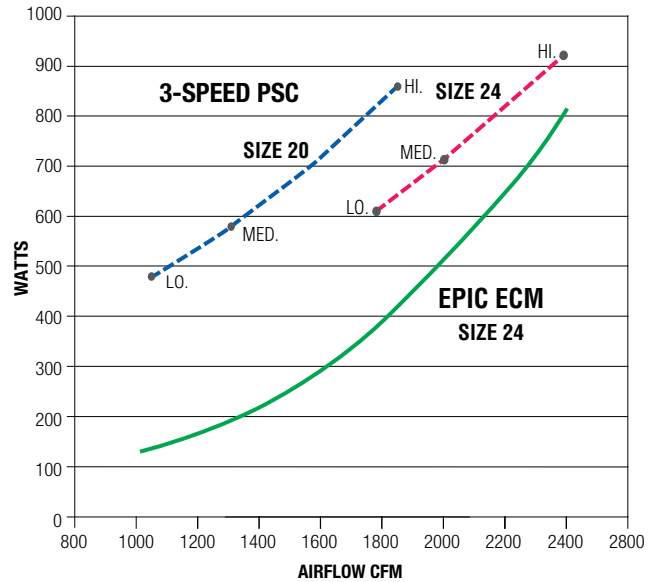
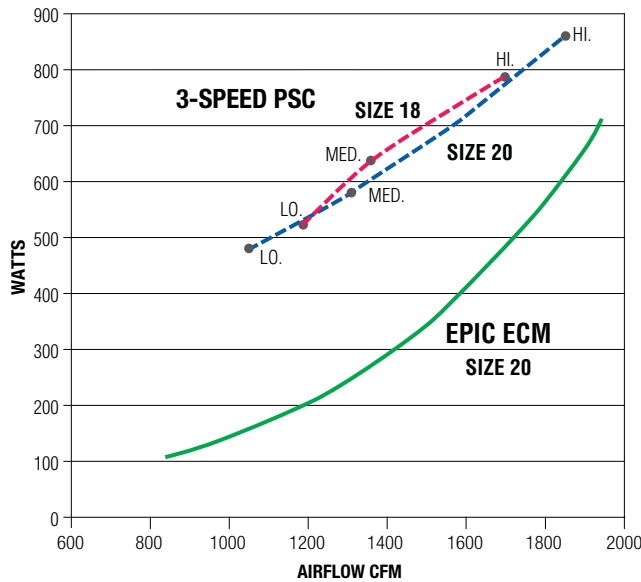
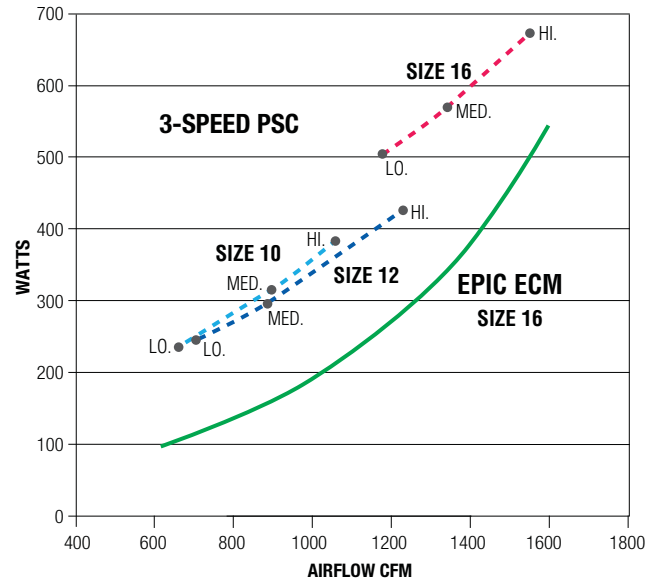
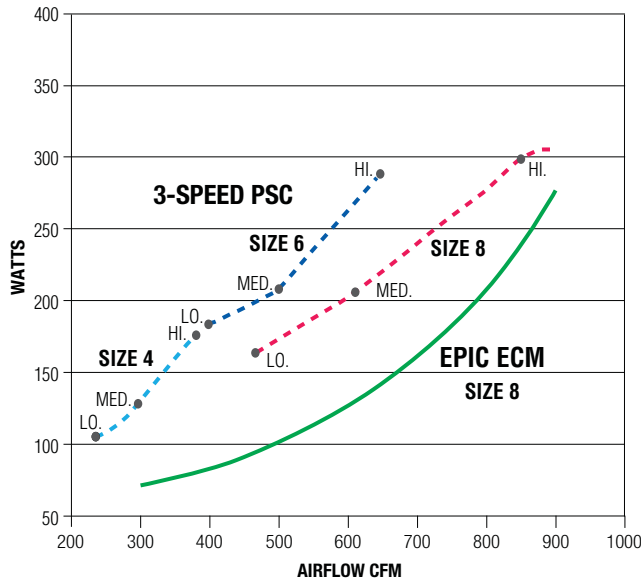

**Percentage (%) ECM Motor Energy Consumption vs. 3-speed PSC Motor**

Unit Size		Airflow Settings		
PSC	ECM	Low	Medium	High
4	8	N/A	54%	43%
6		34%	47%	50%
8		55%	62%	80%
10	16	46%	45%	52%
12		48%	54%	67%
16		52%	60%	75%
18	20	38%	41%	62%
20		34%	43%	71%
24		62%	73%	87%
Average		46%	53%	65%

% = ECM watts/PSC watts x 100

**NOTES:**

1. The graphs plot and illustrate the difference in motor power consumption in Watts between EPIC ECM and 3-speed PSC motors over the fan flow range for each unit size.
2. The EPIC ECM has a much wider airflow range than a 3-speed PSC, hence the reduced number of sizes required.
3. The EPIC ECM is more energy efficient at all operating points. At high speed airflow PSC Settings, the EPIC ECM power consumption is on average 65% of the PSC motor which is 35% in energy savings. However, most fan coils are designed and sized to operate at medium or low speed most of the time. At medium and low speed airflow settings, the EPIC ECM motor power consumption is on average 54% and 47% respectively compared to the PSC motor. This is 46% and 53% in energy savings. Therefore, energy savings are even more substantial at lower speeds. The savings are even greater when an EPIC ECM variable air volume sequence is selected.

## Model Series 35FH • Filter Pressure Drop Adjustments (in w.g.)

Unit Size	Airflow		Velocity		Filter Type			Filter Size
	CFM	l/s	fpm	m/s	1" (25) Throwaway	2" (51) MERV 8	2" (51) MERV 13	
4	400	189	202	1.03	0.032	0.066	0.139	20 x 16 (508 x 406)
	390	184	197	1.00	0.030	0.062	0.134	
	375	177	189	0.96	0.026	0.056	0.126	
	365	172	184	0.93	0.024	0.052	0.121	
6	680	321	343	1.74	0.088	0.179	0.280	20 x 16 (508 x 406)
	660	311	333	1.69	0.084	0.171	0.270	
	650	307	328	1.67	0.082	0.167	0.265	
	630	297	318	1.62	0.078	0.159	0.255	
8	870	411	439	2.23	0.127	0.256	0.376	20 x 16 (508 x 406)
	830	392	419	2.13	0.118	0.239	0.356	
	800	378	404	2.05	0.112	0.227	0.341	
	770	363	389	1.98	0.106	0.215	0.326	
10	1170	552	340	1.73	0.087	0.176	0.277	35 x 16 (889 x 406)
	1140	538	331	1.68	0.083	0.169	0.268	
	1110	524	323	1.64	0.080	0.162	0.260	
	1080	510	314	1.60	0.076	0.155	0.251	
12	1280	604	372	1.89	0.100	0.202	0.309	35 x 16 (889 x 406)
	1250	590	363	1.84	0.096	0.195	0.300	
	1220	576	355	1.80	0.093	0.188	0.292	
	1190	562	346	1.76	0.089	0.181	0.283	
14	1400	661	407	2.07	0.114	0.230	0.344	35 x 16 (889 x 406)
	1350	637	392	1.99	0.108	0.218	0.329	
	1300	614	378	1.92	0.102	0.207	0.315	
	1260	595	366	1.86	0.097	0.197	0.303	
16	1600	755	465	2.36	0.137	0.276	0.402	35 x 16 (889 x 406)
	1540	727	448	2.28	0.130	0.262	0.385	
	1490	703	433	2.20	0.124	0.251	0.370	
	1440	678	419	2.13	0.118	0.240	0.360	
18	1750	826	336	1.71	0.085	0.173	0.273	52 x 16 (1321 x 406)
	1720	812	330	1.68	0.083	0.168	0.267	
	1700	802	326	1.66	0.081	0.165	0.263	
	1680	793	322	1.64	0.080	0.162	0.259	
20	1930	911	370	1.88	0.099	0.200	0.307	52 x 16 (1321 x 406)
	1880	887	361	1.83	0.095	0.193	0.298	
	1840	868	353	1.79	0.092	0.187	0.290	
	1800	850	345	1.75	0.089	0.180	0.282	
24	2400	1133	461	2.34	0.135	0.273	0.398	52 x 16 (1321 x 406)
	2330	1100	447	2.27	0.130	0.262	0.384	
	2230	1052	428	2.17	0.122	0.247	0.365	
	2050	967	393	2.00	0.111	0.219	0.330	
30	3300	1557	476	2.42	0.141	0.284	0.412	52 x 22 (1321 x 559)
	3100	1463	447	2.27	0.129	0.261	0.383	
	3000	1416	432	2.19	0.124	0.250	0.370	
	2900	1369	418	2.12	0.118	0.238	0.355	
40	4100	1935	492	2.50	0.148	0.298	0.429	62 x 22 (1575 x 559)
	3900	1841	468	2.38	0.138	0.279	0.405	
	3700	1746	444	2.26	0.128	0.259	0.381	
	3600	1699	432	2.19	0.124	0.250	0.369	



Front: 1" (25) Throwaway  
Middle: 2" (51) MERV 13  
Back: 2" (51) MERV 8

### NOTES:

1. Pressure drop based on clean filters. Using any type of filter will lower unit airflow.
2. To determine fan airflow with the addition of a filter, add the filter pressure drop to the external static pressure on the fan curve or use Selectworks.

## Model Series 35FH • High Performance • Performance Data Sound Power Levels for PSC Motor and NC Level Application Guide

Unit Size	Airflow CFM    l/s		Discharge Sound Power Levels							Radiated Sound Power Levels								
			Octave Bands							NC	Octave Bands							NC
			2	3	4	5	6	7	2		3	4	5	6	7			
4	380	179	71	70	67	64	61	59	30	79	66	57	51	47	43	46		
	310	146	67	66	63	60	57	55	25	75	62	54	47	43	39	41		
	220	104	64	62	60	55	51	48	21	72	59	51	43	39	35	38		
6	630	297	74	74	70	71	67	66	35	74	68	60	55	49	47	40		
	500	236	69	66	64	61	59	57	25	68	61	55	49	42	39	33		
	390	184	64	61	59	56	54	51	-	66	58	51	44	37	34	30		
8	840	396	68	67	67	66	63	60	25	72	63	58	54	48	44	38		
	610	288	64	61	61	58	55	50	-	68	57	54	48	41	35	33		
	460	217	60	57	57	54	51	44	-	64	54	51	44	36	29	28		
10	1115	526	69	69	69	69	66	65	28	73	64	59	58	52	48	39		
	870	411	64	63	64	62	59	56	20	70	61	57	54	48	44	35		
	700	330	61	60	61	58	55	51	-	67	58	55	52	44	39	31		
12	1220	576	73	71	71	71	66	64	30	75	68	60	58	53	49	41		
	900	425	68	64	64	62	59	56	21	71	62	56	52	46	41	36		
	720	340	65	61	61	59	55	50	-	68	59	54	49	42	36	33		
14	1300	614	73	72	72	72	68	66	31	75	69	61	59	54	50	41		
	1070	505	69	68	68	67	63	61	26	74	66	59	56	50	46	40		
	890	420	67	65	65	63	60	57	23	73	64	57	54	48	44	39		
16	1560	736	72	71	71	71	67	66	30	77	70	62	59	54	51	44		
	1370	647	72	69	69	68	65	63	28	76	68	61	56	51	48	43		
	1240	585	71	67	67	65	62	60	25	75	66	59	54	49	46	41		
18	1720	812	72	73	72	72	68	67	33	74	68	63	60	55	52	40		
	1460	689	70	70	71	68	65	64	29	73	66	61	57	52	49	39		
	1290	609	67	68	69	65	62	61	26	72	64	59	55	49	46	38		
20	1830	864	77	75	73	74	70	70	35	79	71	64	62	57	55	46		
	1390	656	73	68	67	65	61	60	26	74	65	60	55	49	46	40		
	1120	529	73	63	62	61	56	53	25	71	62	58	52	45	41	36		
24	2260	1067	77	74	74	74	71	69	34	78	71	64	61	56	53	45		
	1950	920	75	71	71	71	67	64	30	77	69	63	59	54	50	44		
	1690	798	72	69	69	68	64	61	28	76	67	61	57	52	48	43		

**B**

**HORIZONTAL FAN COIL UNITS • DUCTED**

### Performance Notes:

- Fan discharge (external) static pressure is 0.25" w.g. (63 Pa).
- Sound power levels in decibels, dB re 10<sup>-12</sup> watts.
- All sound data listed by octave bands is raw data without any corrections for room absorption or duct attenuation.
- Data derived from independent tests conducted in accordance with AHRI Standard 880.
- NC levels are calculated from the published raw data and based on procedures outlined in Appendix E, AHRI Standard 885.
- Fan discharge sound attenuation deductions are based on environmental effect, duct lining, branch power division, insulated flexible duct, end reflection and space effect and are as follows:
- Radiated sound attenuation deductions are based on a mineral tile ceiling and environmental effect and are as follows:

Discharge attenuation	Octave Band					
	2	3	4	5	6	7
< 300 cfm	24	28	39	53	58	40
300 – 700 cfm	27	29	40	51	53	39
> 700 cfm	29	30	41	51	52	39

Radiated attenuation	Octave Band					
	2	3	4	5	6	7
Total dB reduction	18	19	20	26	31	36

- Dash (-) in space denotes an NC level of less than 20.

## Model Series 35FH • High Performance • Performance Data Sound Power Levels for EPIC ECM Motor and NC Level Application Guide

Unit Size	Airflow CFM    l/s		Discharge Sound Power Levels							Radiated Sound Power Levels								
			Octave Bands							NC	Octave Bands							NC
			2	3	4	5	6	7	2		3	4	5	6	7			
8	900	425	68	68	68	68	64	62	26	73	65	60	56	50	47	39		
	800	378	66	66	67	65	62	59	24	72	64	59	54	48	45	38		
	700	330	65	64	65	63	59	56	23	69	61	57	52	46	42	34		
	600	283	62	62	63	60	57	53	20	68	59	56	50	43	39	33		
	500	236	60	59	61	58	54	49	-	67	57	54	48	41	36	31		
	400	189	57	57	59	55	52	45	-	64	54	53	45	38	32	28		
16	1600	755	74	72	71	71	68	67	31	77	71	64	61	57	52	44		
	1400	661	71	69	68	67	64	63	28	75	68	60	59	52	48	41		
	1200	566	68	66	65	64	61	59	24	73	65	58	56	49	45	39		
	1000	472	65	63	62	61	57	55	20	70	61	56	51	44	40	35		
	800	378	62	60	60	58	54	50	-	67	58	54	48	41	36	31		
20	2000	944	73	75	74	75	72	71	35	78	71	66	63	59	56	45		
	1800	850	72	73	72	72	70	69	33	77	70	64	62	57	54	44		
	1600	755	71	71	71	70	67	66	30	75	68	62	59	54	51	41		
	1400	661	68	69	69	67	64	63	28	74	66	61	57	51	48	40		
	1200	566	66	65	64	63	60	58	23	72	63	58	54	48	44	38		
	1000	472	64	62	62	60	57	54	-	70	59	56	51	44	40	35		
	800	378	61	59	58	56	53	49	-	66	57	54	48	41	35	30		
24	2550	1204	72	68	69	67	63	62	26	75	71	66	61	57	53	43		
	2400	1133	71	66	67	65	62	60	24	74	69	65	60	56	51	40		
	2200	1038	69	65	65	64	60	58	23	74	69	65	61	56	51	40		
	2000	944	68	63	63	62	58	55	20	73	67	64	59	54	50	39		
	1800	850	66	61	61	60	56	52	-	70	64	60	55	50	44	35		
	1600	755	63	59	60	58	54	49	-	70	62	59	54	48	42	35		
	1400	661	63	57	58	56	51	46	-	67	60	58	51	45	39	33		
	1200	566	59	54	55	53	47	40	-	66	59	56	50	44	36	31		
	1000	472	57	51	52	49	42	34	-	64	57	55	48	41	34	30		

### Performance Notes:

- Fan discharge (external) static pressure is 0.25" w.g. (63 Pa).
- Sound power levels in decibels, dB re 10<sup>-12</sup> watts.
- All sound data listed by octave bands is raw data without any corrections for room absorption or duct attenuation.
- Data derived from independent tests conducted in accordance with AHRI Standard 880.
- NC levels are calculated from the published raw data and based on procedures outlined in Appendix E, AHRI Standard 885.
- Fan discharge sound attenuation deductions are based on environmental effect, duct lining, branch power division, insulated flexible duct, end reflection and space effect and are as follows:

Discharge attenuation	Octave Band						
	2	3	4	5	6	7	
< 300 cfm	24	28	39	53	58	40	
300 – 700 cfm	27	29	40	51	53	39	
> 700 cfm	29	30	41	51	52	39	
- Radiated sound attenuation deductions are based on a mineral tile ceiling and environmental effect and are as follows:

Radiated attenuation	Octave Band						
	2	3	4	5	6	7	
Total dB reduction	18	19	20	26	31	36	
- Dash (–) in space denotes an NC level of less than 20.

B

HORIZONTAL FAN COIL UNITS • DUCTED

## Model Series 35FH • High Performance • Performance Data Sound Power Levels for EPIC ECM Motor and NC Level Application Guide

Unit Size	Airflow CFM l/s		Discharge Sound Power Levels							Radiated Sound Power Levels Non-Ducted Return							Radiated Sound Power Levels Ducted Return									
			Octave Bands							NC	Octave Bands							NC	Octave Bands							NC
			2	3	4	5	6	7	2		3	4	5	6	7	2	3		4	5	6	7				
30	3300	1557	76	73	72	72	69	67	33	75	69	62	59	56	53	41	69	61	52	47	42	37	34			
	3000	1416	75	71	70	70	67	65	30	72	67	60	55	52	49	38	68	59	51	45	40	35	33			
	2600	1227	73	68	68	67	64	62	26	71	65	58	53	50	46	36	66	57	49	43	37	32	30			
	2200	1038	71	66	65	64	61	58	24	69	63	56	50	47	43	34	64	54	46	40	34	27	28			
	1800	850	68	62	62	61	57	53	-	68	60	55	49	45	40	33	62	51	44	37	31	23	25			
	1400	661	65	61	60	59	55	49	-	65	58	53	46	41	35	29	60	50	43	35	28	-	23			
	1000	472	64	59	59	57	52	46	-	64	57	51	43	39	32	28	59	49	41	33	26	-	21			
40	4100	1935	79	76	71	72	68	67	36	77	71	63	59	56	52	44	71	62	54	49	43	37	36			
	3800	1793	78	75	71	70	67	65	35	76	70	62	57	54	50	43	70	62	54	49	44	37	35			
	3400	1605	77	73	69	68	65	62	33	75	68	60	55	52	47	41	68	59	51	45	39	33	33			
	3000	1416	75	71	67	65	62	59	30	73	67	59	53	50	45	39	67	57	49	43	37	30	31			
	2600	1227	73	68	64	63	60	55	26	71	64	57	51	47	41	36	64	55	47	40	34	27	28			
	2200	1038	72	66	62	61	57	52	24	69	62	55	49	45	38	34	63	53	45	38	31	22	26			
	1840	868	69	63	60	58	55	48	20	67	60	54	47	43	36	31	60	50	43	36	30	21	23			

### Performance Notes:

1. Fan discharge (external) static pressure is 0.25" w.g. (63 Pa).
2. Sound power levels in decibels, dB re 10<sup>-12</sup> watts.
3. All sound data listed by octave bands is raw data without any corrections for room absorption or duct attenuation.
4. Data derived from independent tests conducted in accordance with ANSI/ASHRAE Standard 79 and AHRI 260.
5. Ducted return sound levels based on testing with an acoustically isolated (high transmission loss) inlet duct to outside the occupied space.

6. Fan discharge sound attenuation deductions are based on environmental effect, duct lining, branch power division, insulated flexible duct, end reflection and space effect and are as follows:

Discharge attenuation	Octave Band						
	2	3	4	5	6	7	
< 300 cfm	24	28	39	53	58	40	
300 – 700 cfm	27	29	40	51	53	39	
> 700 cfm	29	30	41	51	52	39	

7. Radiated sound attenuation deductions are based on a mineral tile ceiling and environmental effect and are as follows:

Radiated attenuation	Octave Band						
	2	3	4	5	6	7	
Total dB reduction	18	19	20	26	31	36	

8. Dash (–) in space denotes an NC level of less than 20.

## Model Series 35FH • Performance Data 2-pipe System • Cooling and Heating AHRI Standard Ratings

Unit Size	Airflow		Main Coil Rows	Cooling Capacity 1				Heating Capacity 2		PSC Motor (Watts)
	CFM	l/s		TMBH	kW	SMBH	kW	MBH	kW	
4	400	189	3	13.1	3.8	9.0	2.6	23.3	6.8	175
	390	184	4	14.8	4.3	9.8	2.9	25.2	7.4	170
	375	177	5	15.7	4.6	10.0	2.9	25.8	7.6	165
	375	177	6	16.6	4.9	10.5	3.1	26.7	7.8	165
6	680	321	3	18.1	5.3	13.3	3.9	34.3	10.1	280
	660	311	4	21.1	6.2	14.8	4.3	38.4	11.2	275
	650	307	5	23.4	6.9	15.8	4.6	41.2	12.1	270
	630	297	6	24.8	7.3	16.3	4.8	42.3	12.4	265
8	870	411	3	21.0	6.2	16.0	4.7	40.5	11.9	310
	830	392	4	24.5	7.2	17.7	5.2	45.6	13.4	305
	800	378	5	27.1	7.9	18.8	5.5	48.6	14.2	300
	770	363	6	28.7	8.4	19.3	5.7	50.0	14.7	295
10	1170	552	3	30.2	8.9	22.7	6.7	58.3	17.1	450
	1140	538	4	38.0	11.2	26.3	7.7	67.2	19.7	440
	1110	524	5	43.5	12.7	28.5	8.4	72.2	21.2	430
	1080	510	6	45.2	13.2	29.1	8.5	73.7	21.6	420
12	1280	604	3	31.9	9.3	24.2	7.1	62.1	18.2	500
	1250	590	4	40.3	11.8	28.1	8.2	72.1	21.1	490
	1220	576	5	46.5	13.6	30.8	9.0	77.9	22.8	475
	1190	562	6	48.4	14.2	31.5	9.2	80.0	23.5	460
14	1400	661	3	33.4	9.8	25.7	7.5	65.9	19.3	575
	1350	637	4	42.2	12.4	29.7	8.7	76.4	22.4	560
	1300	614	5	48.5	14.2	32.3	9.5	82.1	24.1	540
	1260	595	6	50.5	14.8	33.0	9.7	84.1	24.6	530
16 <sup>3</sup>	1600	755	3	35.3	10.3	27.7	8.1	71.9	21.1	785
	1540	727	4	45.2	13.2	32.3	9.5	84.1	24.7	755
	1490	703	5	52.6	15.4	35.4	10.4	91.4	26.8	740
	1490	703	6	56.2	16.5	37.3	10.9	96.6	28.3	730
18 <sup>4</sup>	1750	826	3	50.1	14.7	35.5	10.4	91.1	26.7	830
	1720	812	4	58.6	17.2	39.8	11.7	102.4	30.0	820
	1700	802	5	67.3	19.7	43.7	12.8	110.9	32.5	805
	1680	793	6	73.7	21.6	46.5	13.6	115.9	34.0	795
20 <sup>4</sup>	1930	911	3	52.9	15.5	38.0	11.1	97.6	28.6	935
	1880	887	4	61.9	18.1	42.5	12.5	109.7	32.1	915
	1840	868	5	71.2	20.9	46.5	13.6	118.4	34.7	895
	1800	850	6	77.6	22.7	49.2	14.4	123.0	36.1	860
24 <sup>4</sup>	2400	1133	3	60.1	17.6	44.7	13.1	113.2	33.2	1000
	2330	1100	4	71.1	20.8	50.3	14.7	128.6	37.7	980
	2230	1052	5	81.5	23.9	54.5	16.0	138.1	40.5	950
	2050	967	6	85.7	25.1	54.9	16.1	137.5	40.3	940

All performance based on actual airflow using PSC motors. Cooling performance is based on 80°F DB and 67°F WB (26.7/19.4C), 45°F (7.2°C) and a 10°F (5.6°C) temperature rise.

Heating performance is based on 70°F (21.1°C) entering air temperature, 140°F (60°C) entering hot water temperature performance unit.

1. Dissipated PSC motor heat taken into account within cooling capacity. Dissipated capacity for an ECM is less, providing you a higher cooling capacity.
2. For specific performance outside of AHRI condition request selection software SelectWorks, through your nearest sales representative or for a quick glance, go to coil performance curves on pages B26 through B33. PSC motor watts at full load.
3. Only the five (5) & six (6) row coils are certified to AHRI standard 440. The three (3) & four (4) row coil airflow/capacity falls outside the scope of the program.
4. Not AHRI certified to standard 440 as the unit airflow / capacity falls outside the program scope.

B

HORIZONTAL FAN COIL UNITS • DUCTED



## Model Series 35FH • Chilled Water Coil Performance Data Unit Sizes 4 – 8

Data Based on 80°F DB, 67°F WB Entering Air & 45°F Entering Water

**3 Row (Total MBH)**

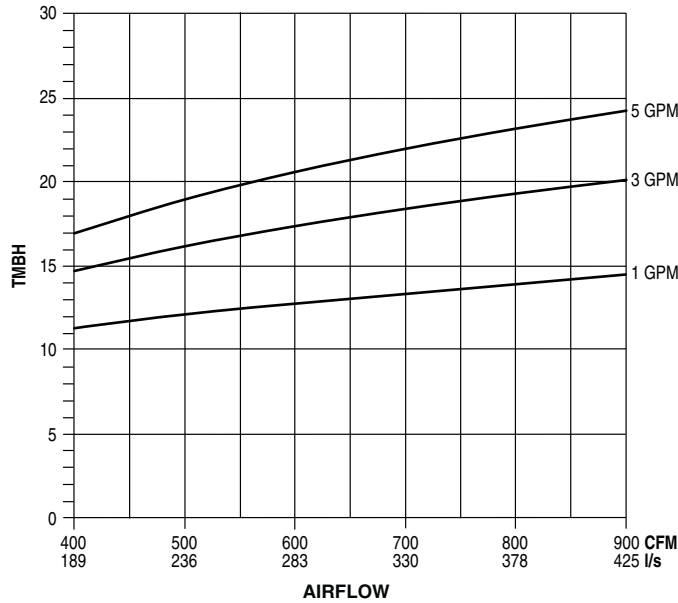

**4 Row (Total MBH)**

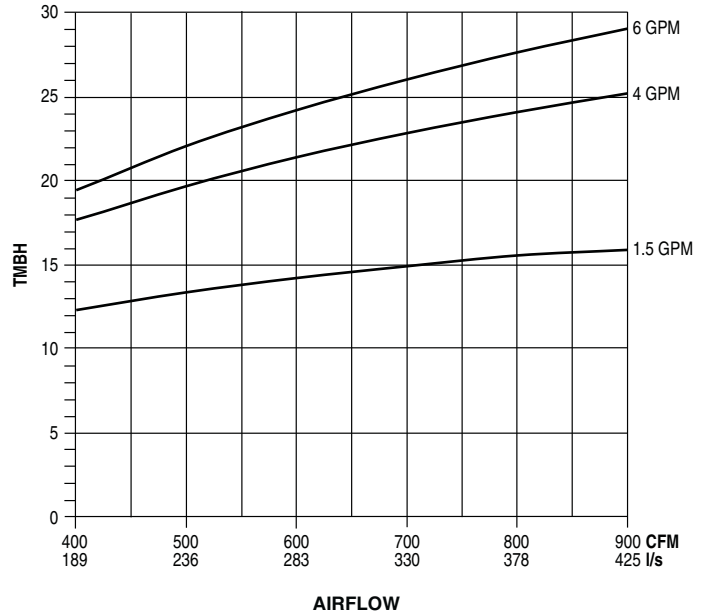

**3 Row (Sensible MBH)**

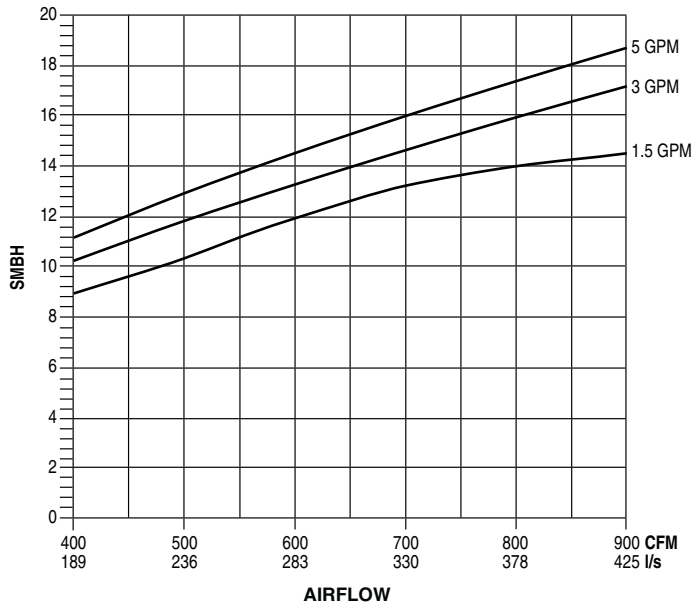

**4 Row (Sensible MBH)**

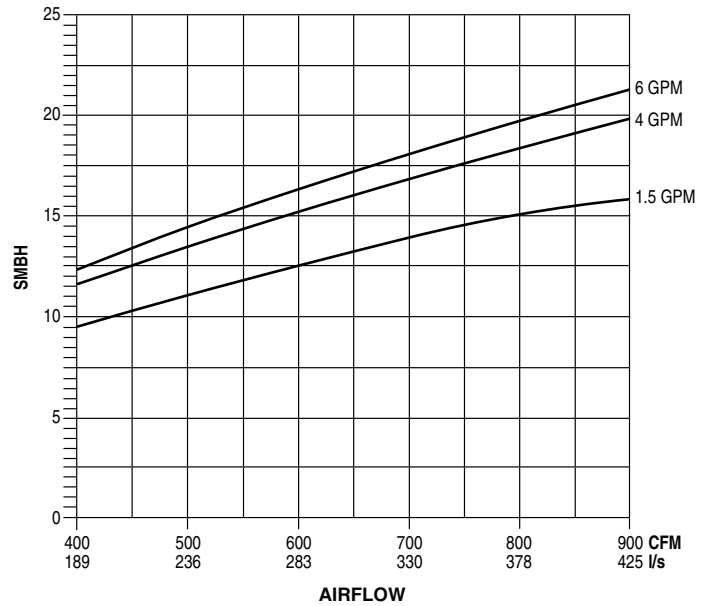

### Altitude Correction Factors

Altitude (ft.)	0	1000	2000	3000	4000	5000	6000	7000
Air Density (lb./cu. ft)	0.075	0.072	0.070	0.067	0.065	0.063	0.060	0.058
Total Capacity	1000	0.988	0.986	0.983	0.981	0.979	0.977	0.975
Sensible Capacity	1000	0.960	0.930	0.900	0.860	0.830	0.800	0.770
Static Pressure	1000	0.960	0.930	0.900	0.860	0.830	0.800	0.770

### Notes:

- Capacity and static pressure will be affected for applications above sea level. To apply correction factors, multiply the coil capacity or fan curve data by the tabulated correction factor.
- Connections: 3 and 4 Row 7/8" (22.2) O.D. male solder.



## Model Series 35FH • Chilled Water Coil Performance Data

### Unit Sizes 4 – 8

Data Based on 80°F DB, 67°F WB Entering Air & 45°F Entering Water

5 Row (Total MBH)

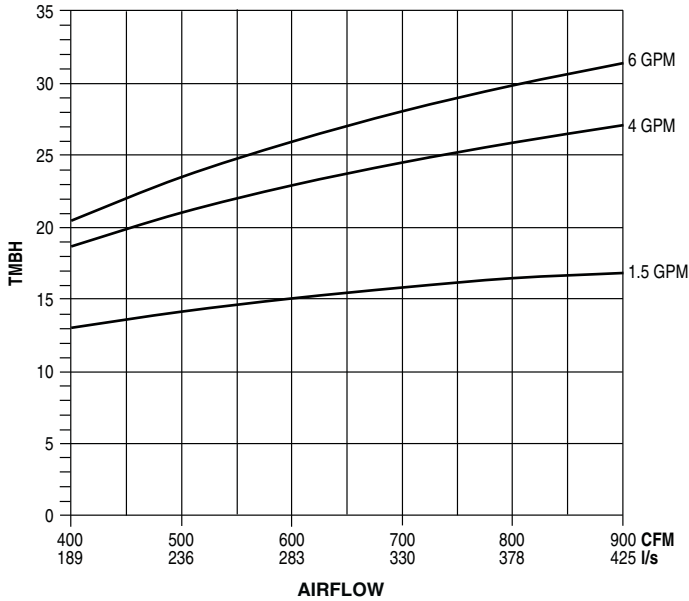

6 Row (Total MBH)

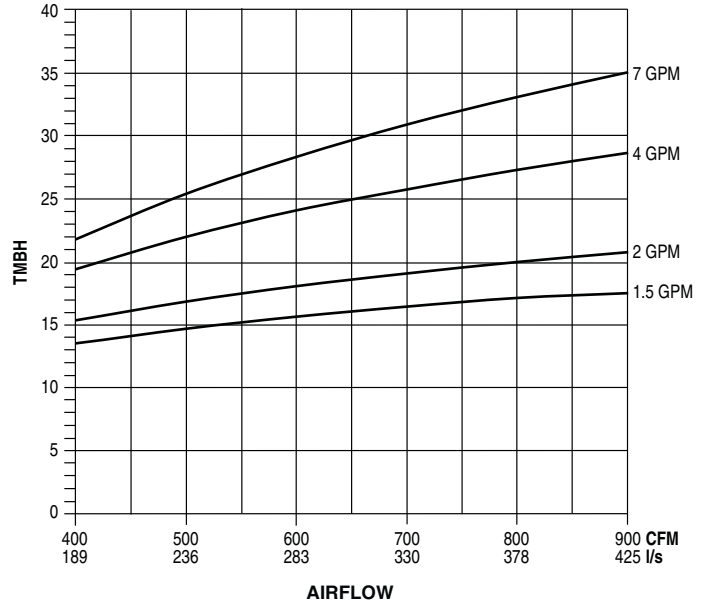

5 Row (Sensible MBH)

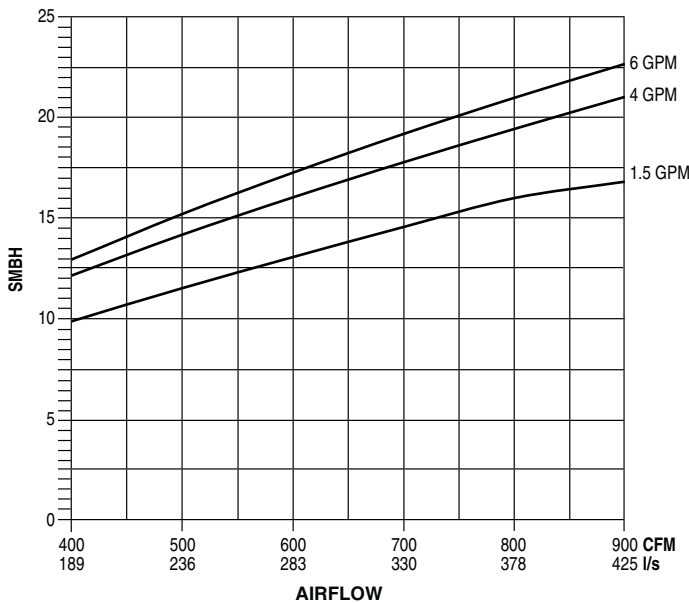

6 Row (Sensible MBH)

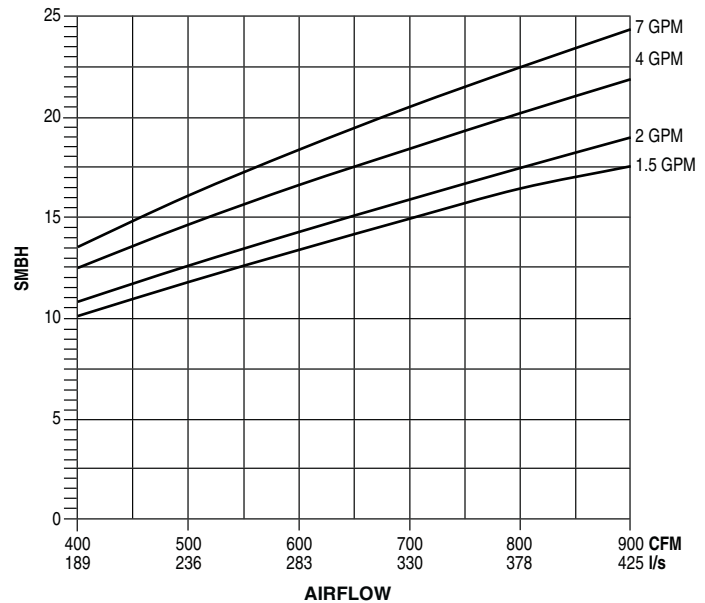

### Altitude Correction Factors

Altitude (ft.)	0	1000	2000	3000	4000	5000	6000	7000
Air Density (lb./cu. ft)	0.075	0.072	0.070	0.067	0.065	0.063	0.060	0.058
Total Capacity	1000	0.988	0.986	0.983	0.981	0.979	0.977	0.975
Sensible Capacity	1000	0.960	0.930	0.900	0.860	0.830	0.800	0.770
Static Pressure	1000	0.960	0.930	0.900	0.860	0.830	0.800	0.770

### Notes:

- Capacity and static pressure will be affected for applications above sea level. To apply correction factors, multiply the coil capacity or fan curve data by the tabulated correction factor.
- Connections: 5 and 6 Row 7/8" (22.2) O.D. male solder.

B HORIZONTAL FAN COIL UNITS • DUCTED

## Model Series 35FH • Chilled Water Coil Performance Data Unit Sizes 10 – 16

Data Based on 80°F DB, 67°F WB Entering Air & 45°F Entering Water

**3 Row (Total MBH)**

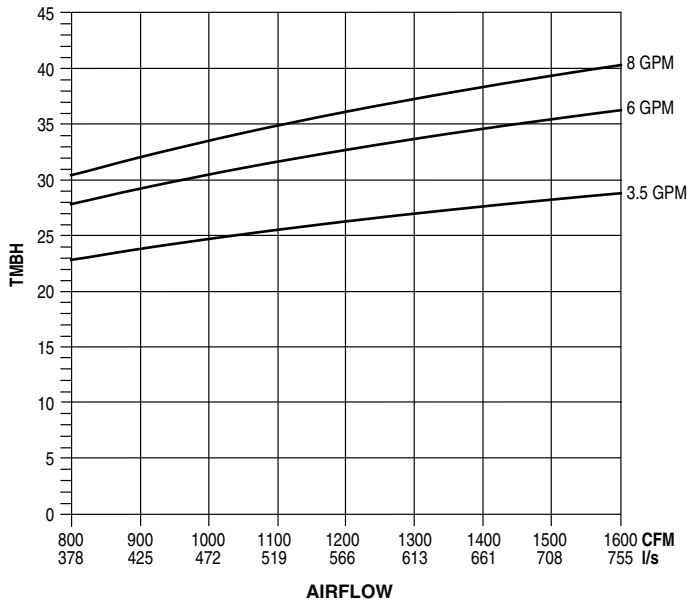

**4 Row (Total MBH)**

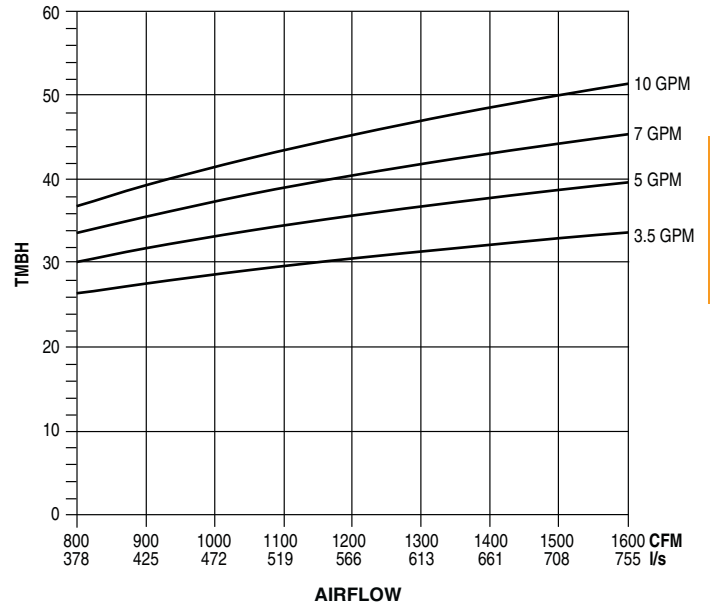

**3 Row (Sensible MBH)**

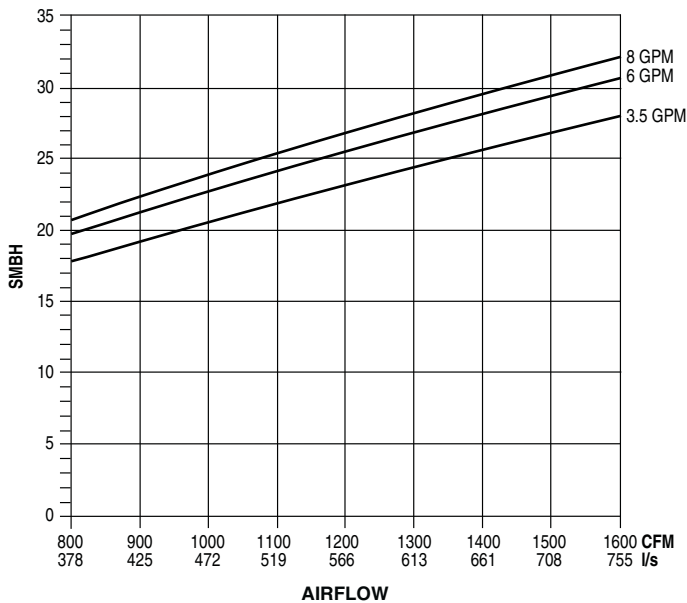

**4 Row (Sensible MBH)**

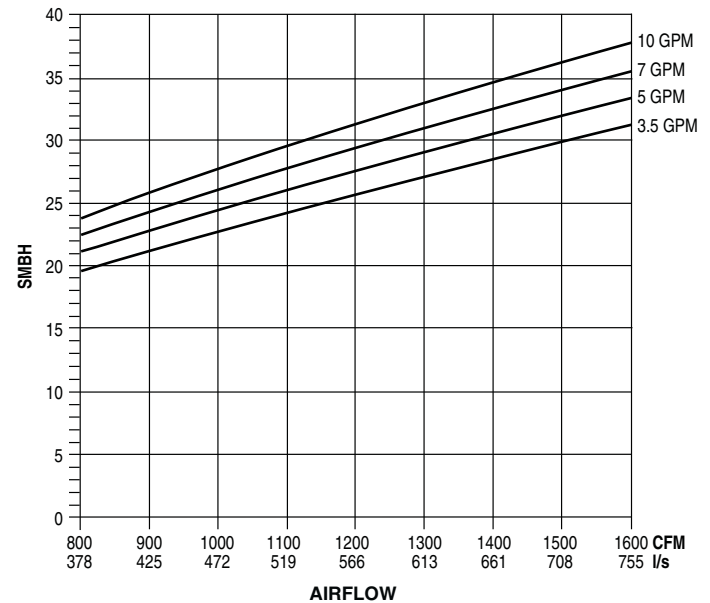

### Altitude Correction Factors

Altitude (ft.)	0	1000	2000	3000	4000	5000	6000	7000
Air Density (lb./cu. ft.)	0.075	0.072	0.070	0.067	0.065	0.063	0.060	0.058
Total Capacity	1000	0.988	0.986	0.983	0.981	0.979	0.977	0.975
Sensible Capacity	1000	0.960	0.930	0.900	0.860	0.830	0.800	0.770
Static Pressure	1000	0.960	0.930	0.900	0.860	0.830	0.800	0.770

### NOTES:

- Capacity and static pressure will be affected for applications above sea level. To apply correction factors, multiply the coil capacity or fan curve data by the tabulated correction factor.
- Connections: 3 and 4 Row 7/8" (22.2) O.D. male solder.

**B**

HORIZONTAL FAN COIL UNITS • DUCTED

## Model Series 35FH • Chilled Water Coil Performance Data

### Unit Sizes 10 – 16

Data Based on 80°F DB, 67°F WB Entering Air & 45°F Entering Water

5 Row (Total MBH)

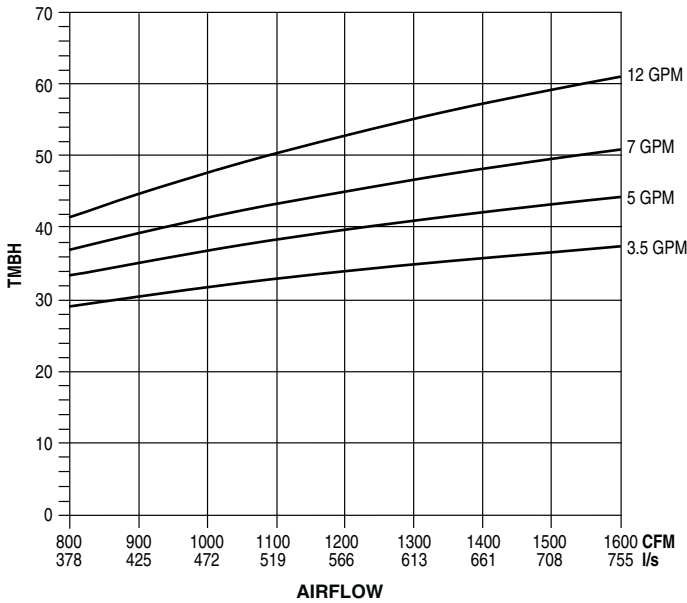

6 Row (Total MBH)

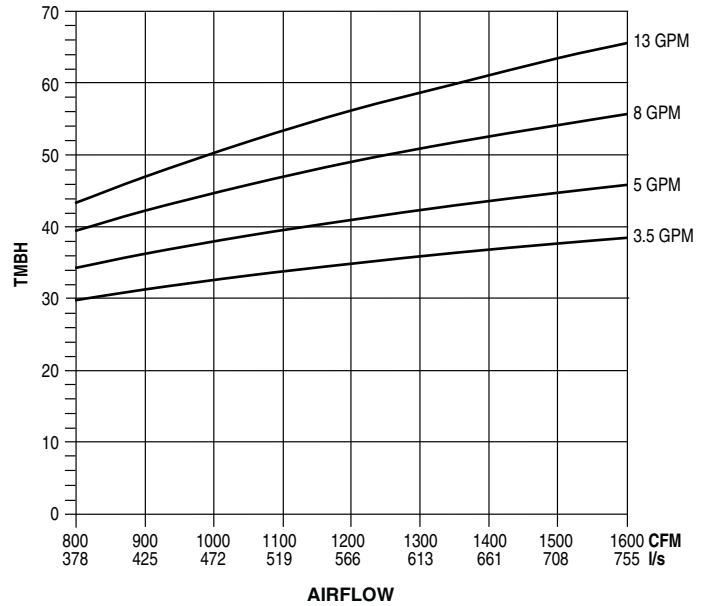

5 Row (Sensible MBH)

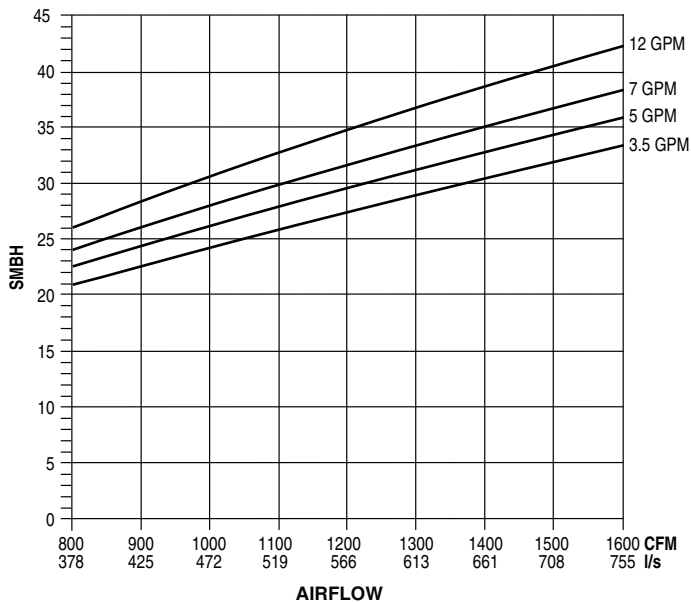

6 Row (Sensible MBH)

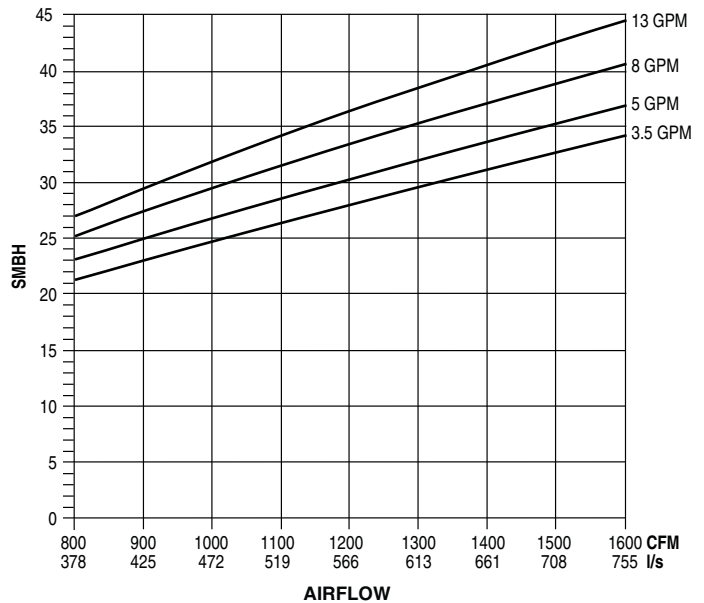

### Altitude Correction Factors

Altitude (ft.)	0	1000	2000	3000	4000	5000	6000	7000
Air Density (lb./cu.ft)	0.075	0.072	0.070	0.067	0.065	0.063	0.060	0.058
Total Capacity	1000	0.988	0.986	0.983	0.981	0.979	0.977	0.975
Sensible Capacity	1000	0.960	0.930	0.900	0.860	0.830	0.800	0.770
Static Pressure	1000	0.960	0.930	0.900	0.860	0.830	0.800	0.770

### NOTES:

- Capacity and static pressure will be affected for applications above sea level. To apply correction factors, multiply the coil capacity or fan curve data by the tabulated correction factor.
- Connections: 5 and 6 Row 7/8" (22.2) O.D. male solder.

B

HORIZONTAL FAN COIL UNITS • DUCTED

## Model Series 35FH • Chilled Water Coil Performance Data Unit Sizes 18 – 24

Data Based on 80°F DB, 67°F WB Entering Air & 45°F Entering Water

**3 Row (Total MBH)**

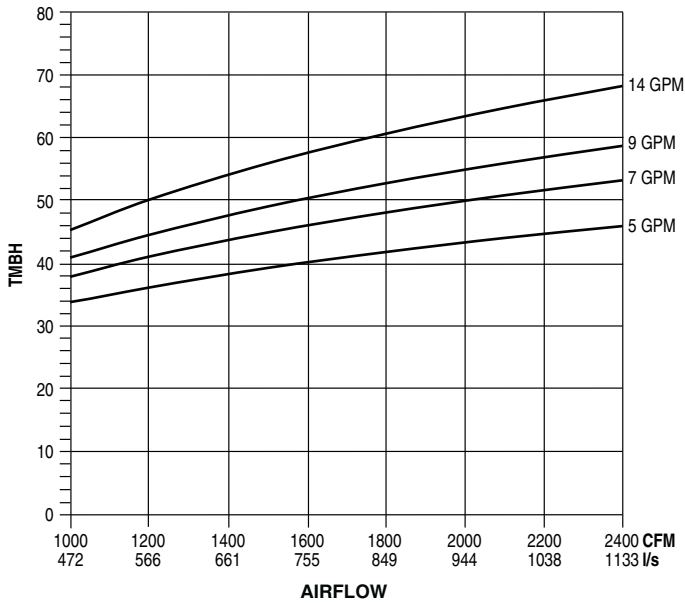

**4 Row (Total MBH)**

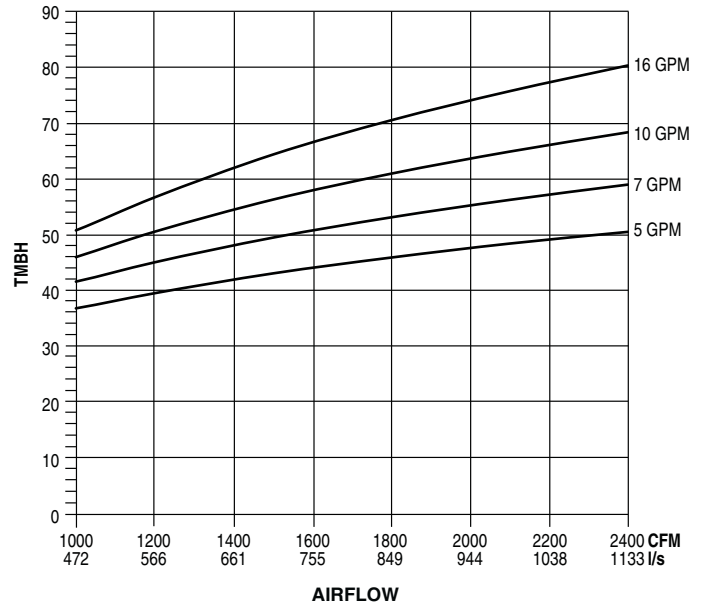

**3 Row (Sensible MBH)**

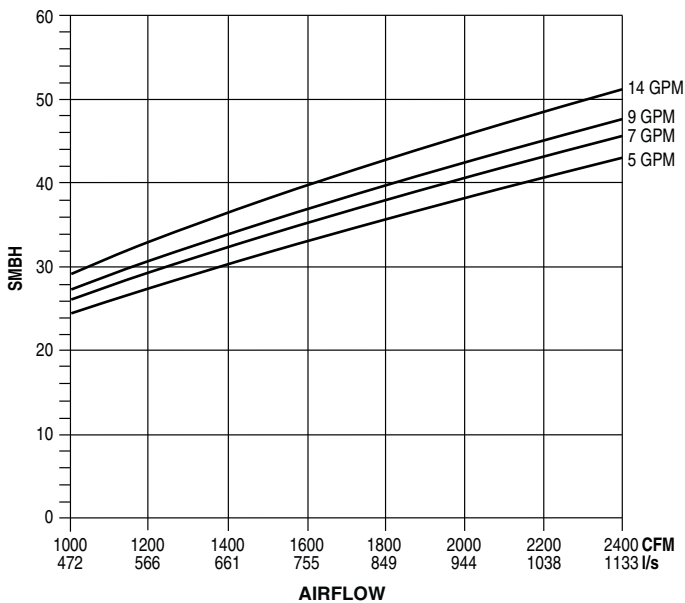

**4 Row (Sensible MBH)**

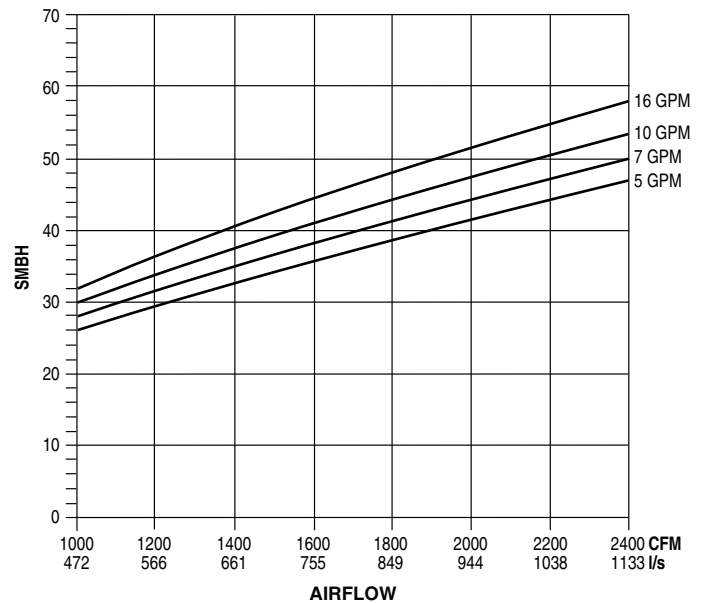

**B**

HORIZONTAL FAN COIL UNITS • DUCTED

### Altitude Correction Factors

Altitude (ft.)	0	1000	2000	3000	4000	5000	6000	7000
Air Density (lb./cu.ft)	0.075	0.072	0.070	0.067	0.065	0.063	0.060	0.058
Total Capacity	1000	0.988	0.986	0.983	0.981	0.979	0.977	0.975
Sensible Capacity	1000	0.960	0.930	0.900	0.860	0.830	0.800	0.770
Static Pressure	1000	0.960	0.930	0.900	0.860	0.830	0.800	0.770

### NOTES:

- Capacity and static pressure will be affected for applications above sea level. To apply correction factors, multiply the coil capacity or fan curve data by the tabulated correction factor.
- Connections: 3 and 4 Row 1 1/8" (28.6) O.D. male solder.

## Model Series 35FH • Chilled Water Coil Performance Data

### Unit Sizes 18 – 24

Data Based on 80°F DB, 67°F WB Entering Air & 45°F Entering Water

5 Row (Total MBH)

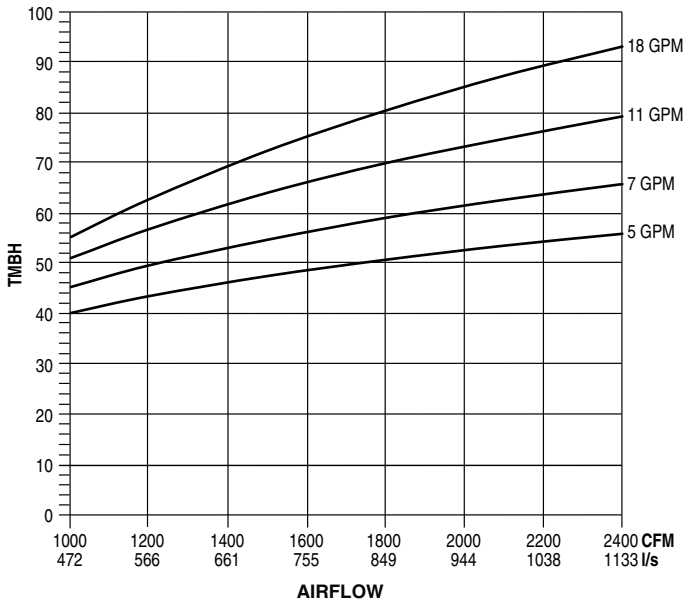

6 Row (Total MBH)

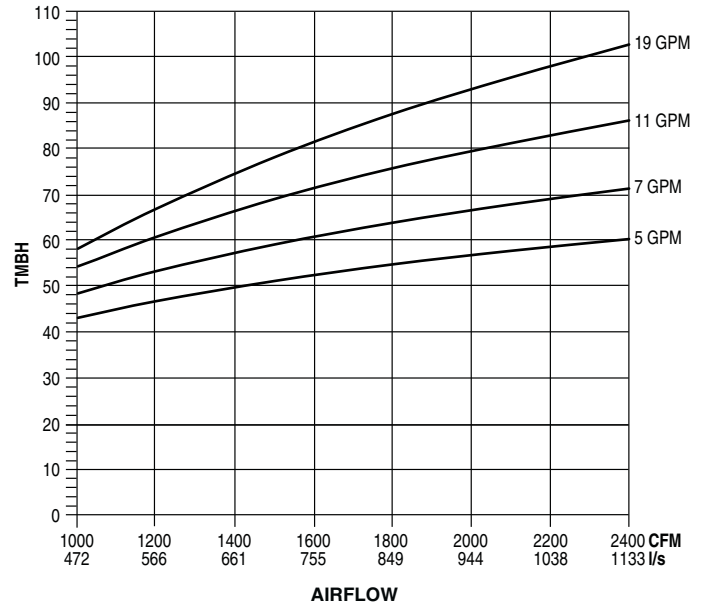

5 Row (Sensible MBH)

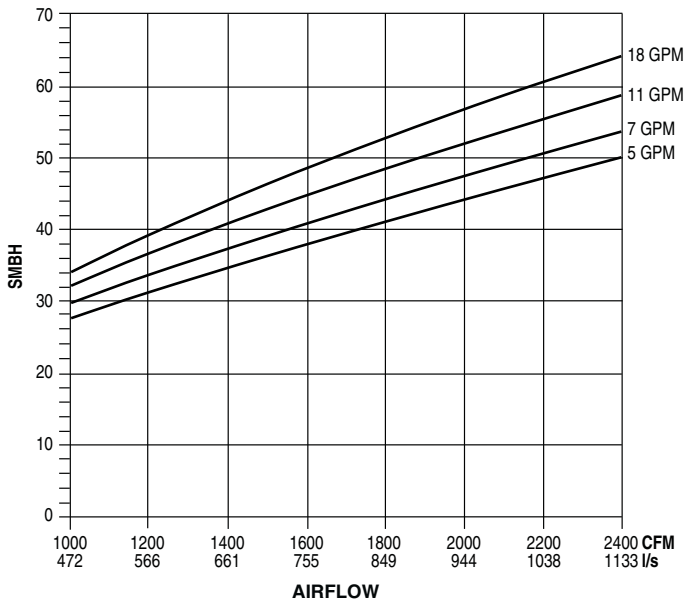

6 Row (Sensible MBH)

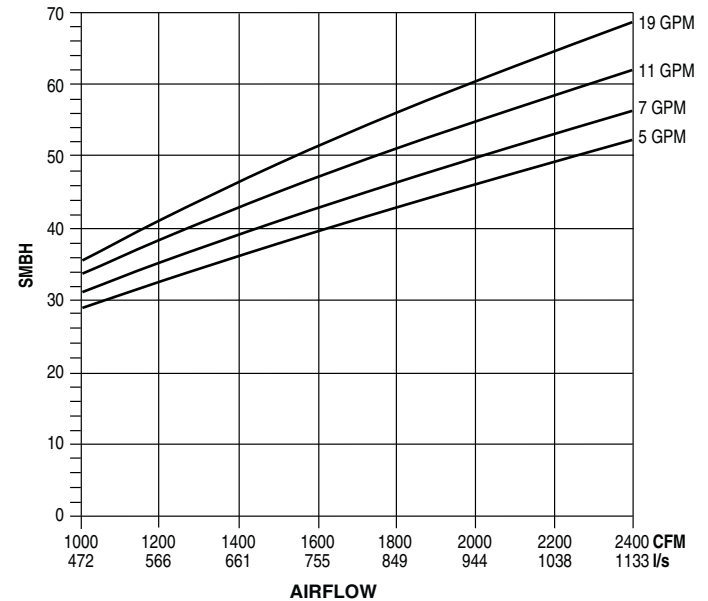

### Altitude Correction Factors

Altitude (ft.)	0	1000	2000	3000	4000	5000	6000	7000
Air Density (lb./cu.ft)	0.075	0.072	0.070	0.067	0.065	0.063	0.060	0.058
Total Capacity	1000	0.988	0.986	0.983	0.981	0.979	0.977	0.975
Sensible Capacity	1000	0.960	0.930	0.900	0.860	0.830	0.800	0.770
Static Pressure	1000	0.960	0.930	0.900	0.860	0.830	0.800	0.770

### NOTES:

- Capacity and static pressure will be affected for applications above sea level. To apply correction factors, multiply the coil capacity or fan curve data by the tabulated correction factor.
- Connections: 5 and 6 Row 1 1/8" (28.6) O.D. male solder.

B

HORIZONTAL FAN COIL UNITS • DUCTED

## Model Series 35FH • Chilled Water Coil Performance Data Unit Size 30

Data Based on 80°F DB, 67°F WB Entering Air & 45°F Entering Water

3 Row (Total MBH)

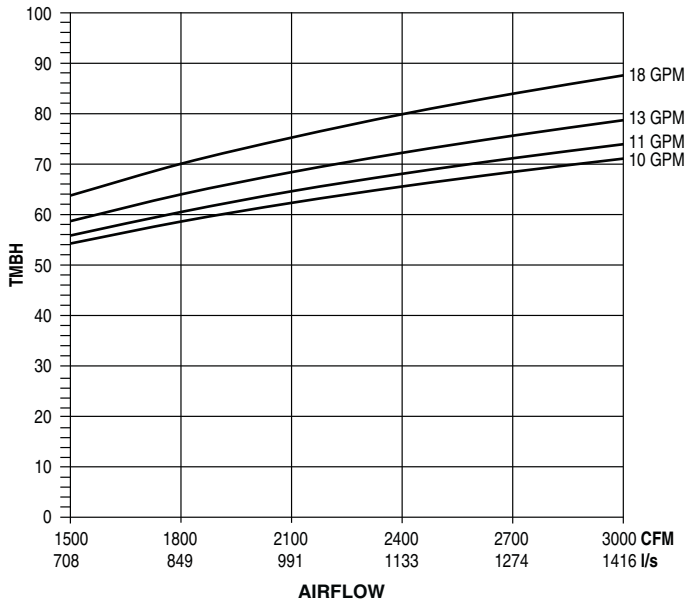

4 Row (Total MBH)

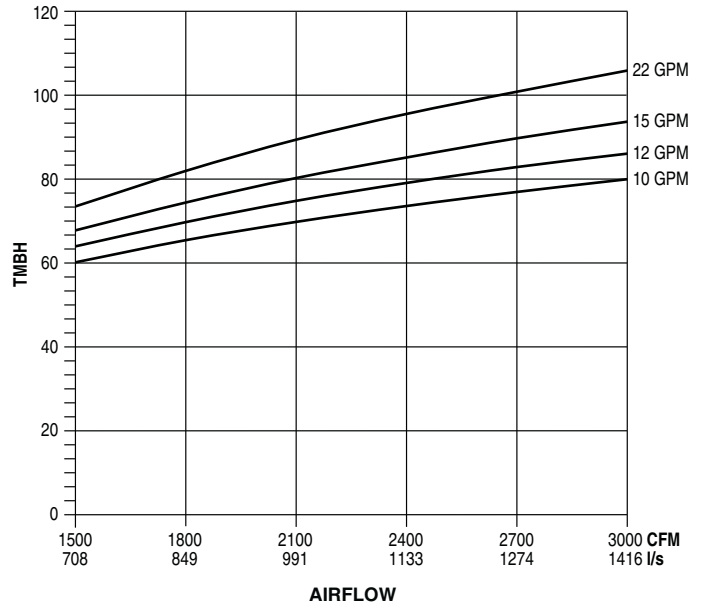

3 Row (Sensible MBH)

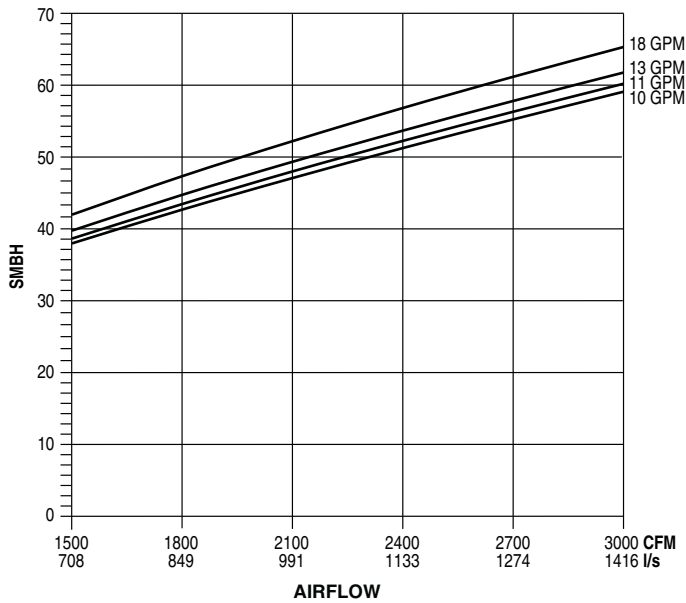

4 Row (Sensible MBH)

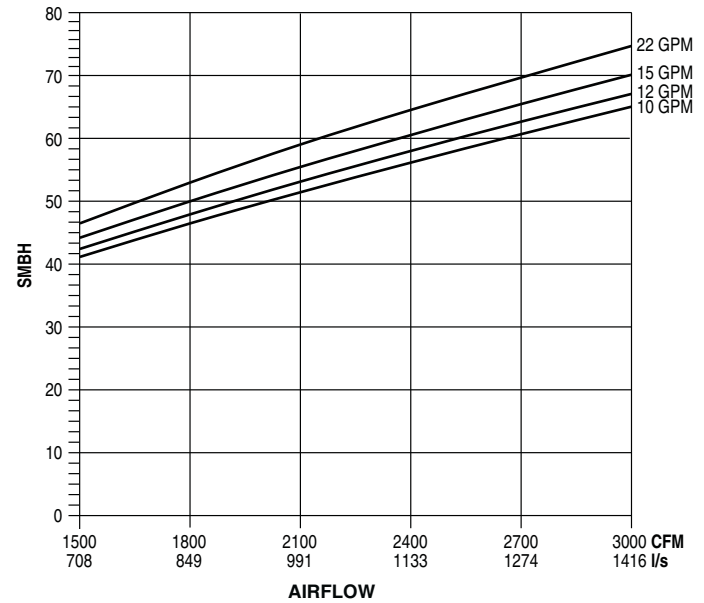

### Altitude Correction Factors

Altitude (ft.)	0	1000	2000	3000	4000	5000	6000	7000
Air Density (lb./cu.ft)	0.075	0.072	0.070	0.067	0.065	0.063	0.060	0.058
Total Capacity	1000	0.988	0.986	0.983	0.981	0.979	0.977	0.975
Sensible Capacity	1000	0.960	0.930	0.900	0.860	0.830	0.800	0.770
Static Pressure	1000	0.960	0.930	0.900	0.860	0.830	0.800	0.770

### NOTES:

- Capacity and static pressure will be affected for applications above sea level. To apply correction factors, multiply the coil capacity or fan curve data by the tabulated correction factor.
- Connections: 5 and 6 Row 1 1/8" (28.6) O.D. male solder.

## Model Series 35FH • Chilled Water Coil Performance Data

### Unit Size 30

Data Based on 80°F DB, 67°F WB Entering Air & 45°F Entering Water

5 Row (Total MBH)

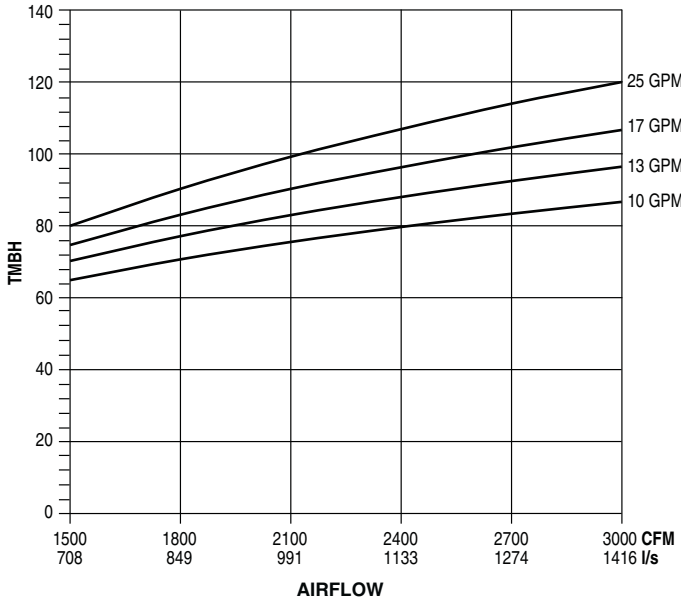

6 Row (Total MBH)

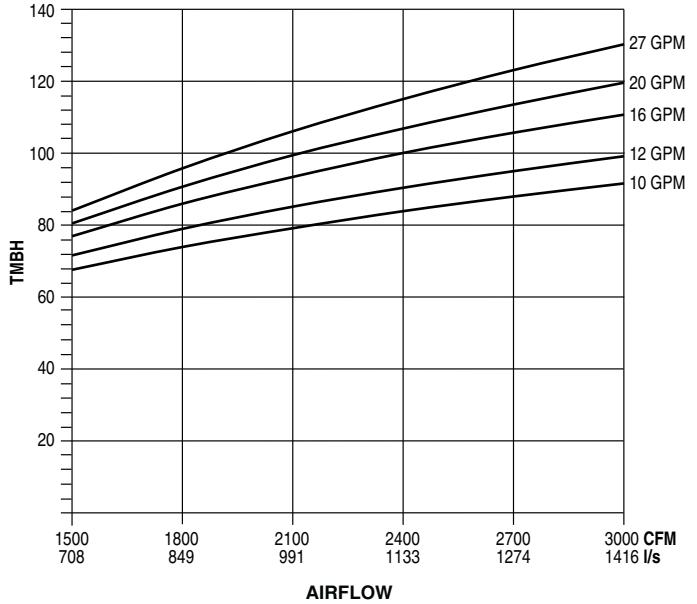

5 Row (Sensible MBH)

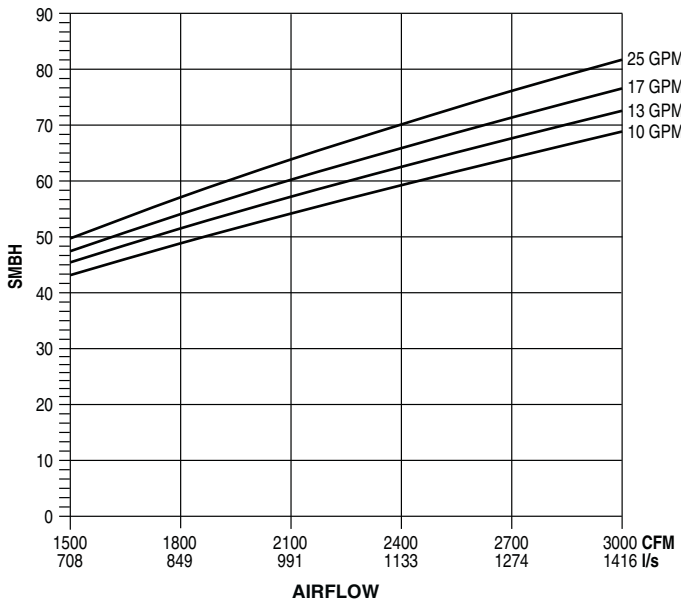

6 Row (Sensible MBH)

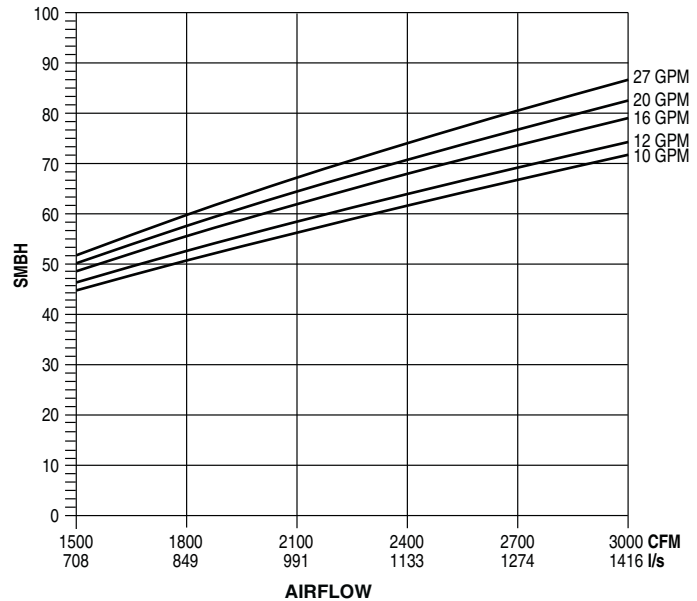

### Altitude Correction Factors

Altitude (ft.)	0	1000	2000	3000	4000	5000	6000	7000
Air Density (lb./cu.ft)	0.075	0.072	0.070	0.067	0.065	0.063	0.060	0.058
Total Capacity	1000	0.988	0.986	0.983	0.981	0.979	0.977	0.975
Sensible Capacity	1000	0.960	0.930	0.900	0.860	0.830	0.800	0.770
Static Pressure	1000	0.960	0.930	0.900	0.860	0.830	0.800	0.770

### NOTES:

- Capacity and static pressure will be affected for applications above sea level. To apply correction factors, multiply the coil capacity or fan curve data by the tabulated correction factor.
- Connections: 5 and 6 Row 1 1/8" (28.6) O.D. male solder.

B

HORIZONTAL FAN COIL UNITS • DUCTED



## Model Series 35FH • Chilled Water Coil Performance Data Unit Size 40

Data Based on 80°F DB, 67°F WB Entering Air & 45°F Entering Water

**3 Row (Total MBH)**

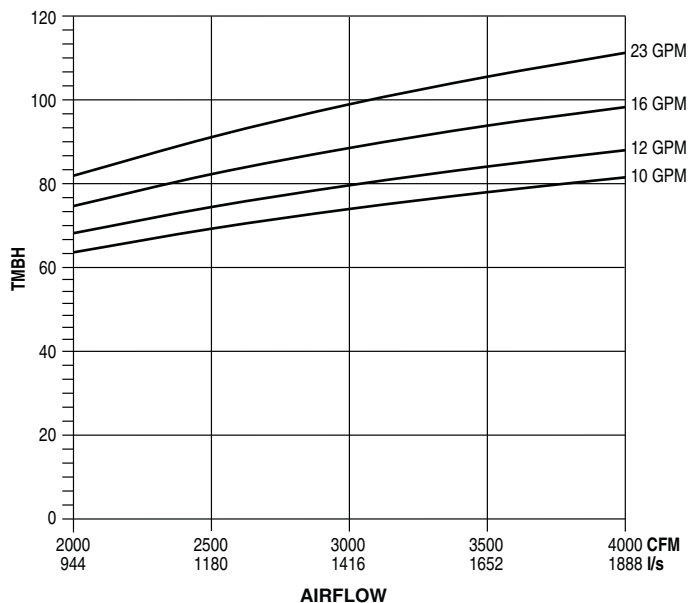

**4 Row (Total MBH)**

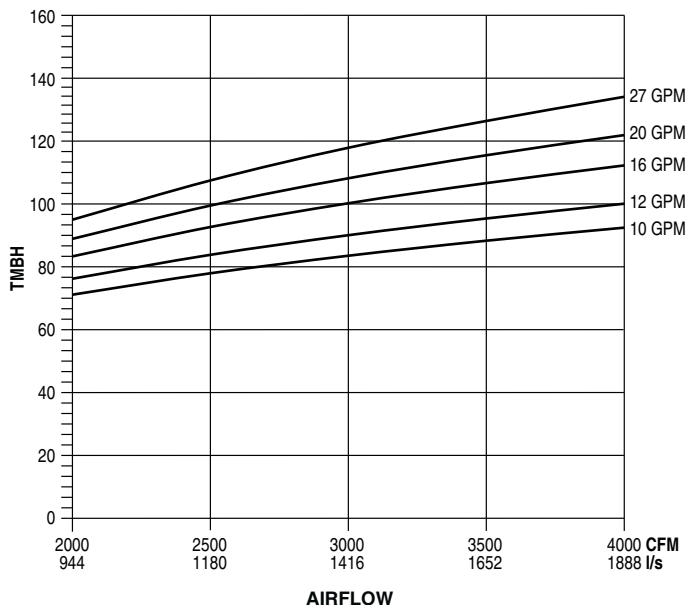

**3 Row (Sensible MBH)**

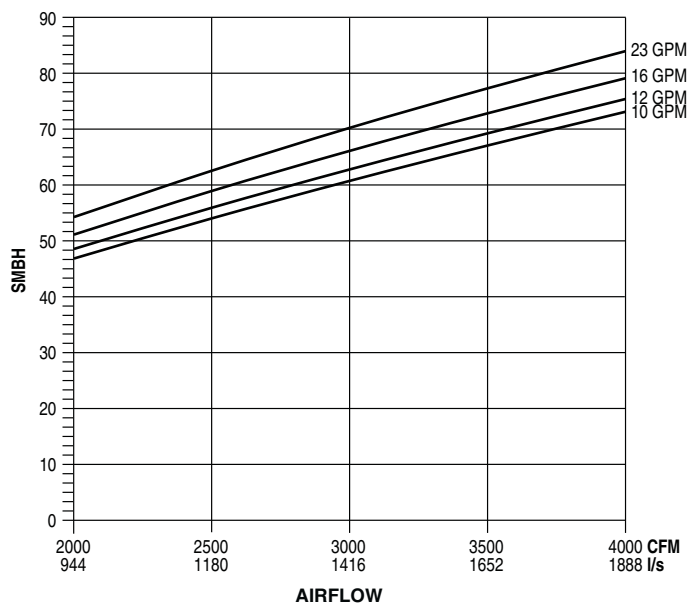

**4 Row (Sensible MBH)**

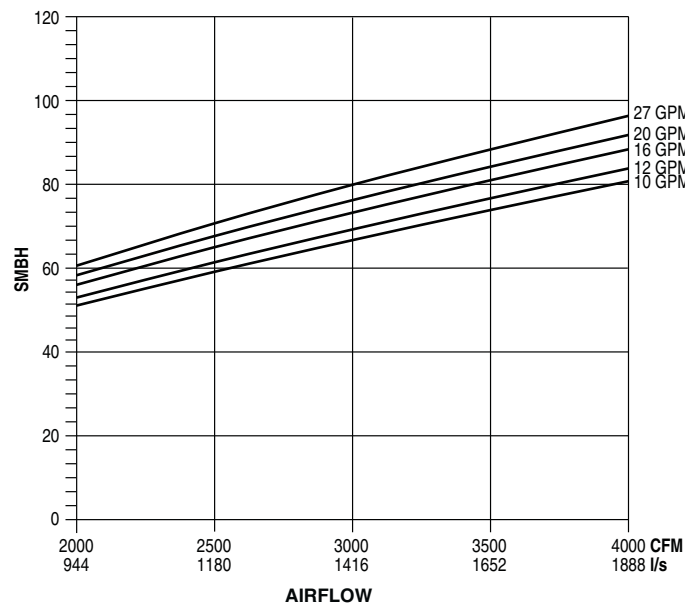

### Altitude Correction Factors

Altitude (ft.)	0	1000	2000	3000	4000	5000	6000	7000
<b>Air Density (lb./cu.ft)</b>	0.075	0.072	0.070	0.067	0.065	0.063	0.060	0.058
<b>Total Capacity</b>	1000	0.988	0.986	0.983	0.981	0.979	0.977	0.975
<b>Sensible Capacity</b>	1000	0.960	0.930	0.900	0.860	0.830	0.800	0.770
<b>Static Pressure</b>	1000	0.960	0.930	0.900	0.860	0.830	0.800	0.770

### NOTES:

- Capacity and static pressure will be affected for applications above sea level. To apply correction factors, multiply the coil capacity or fan curve data by the tabulated correction factor.
- Connections: 5 and 6 Row 1 1/8" (28.6) O.D. male solder.

## Model Series 35FH • Chilled Water Coil Performance Data

### Unit Size 40

Data Based on 80°F DB, 67°F WB Entering Air & 45°F Entering Water

5 Row (Total MBH)

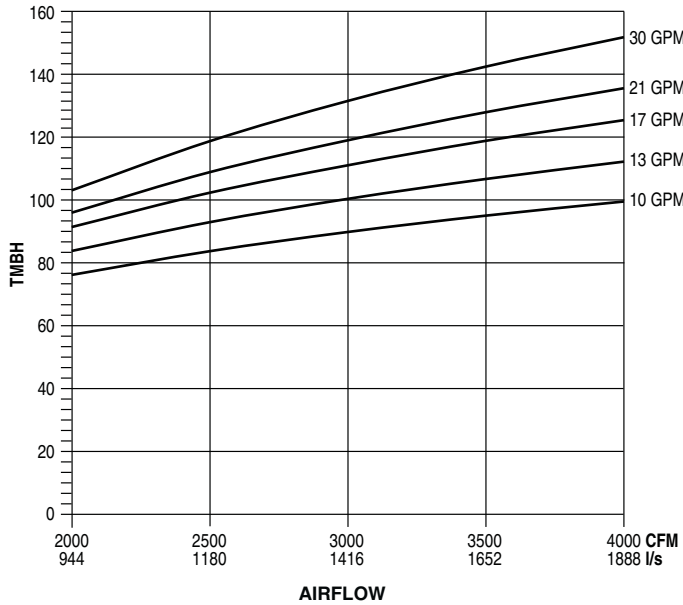

6 Row (Total MBH)

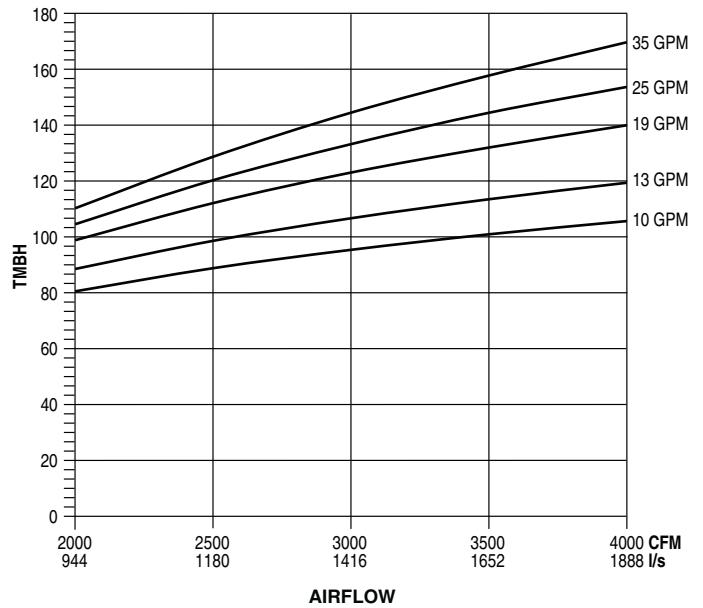

5 Row (Sensible MBH)

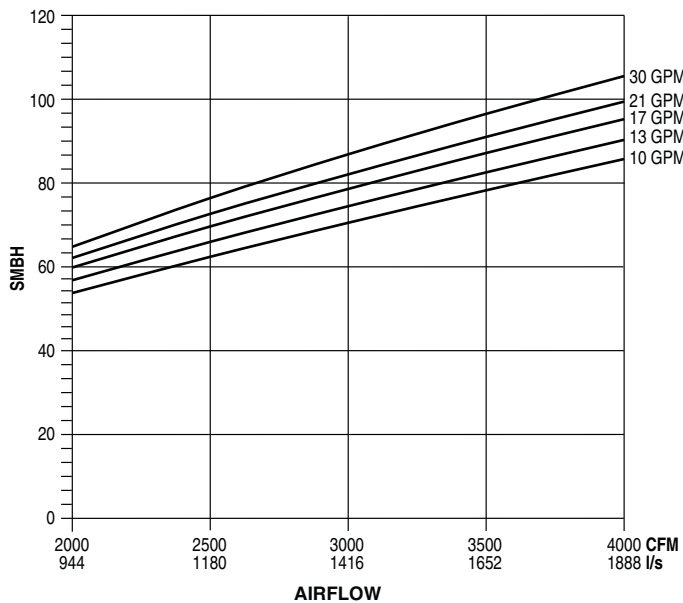

6 Row (Sensible MBH)

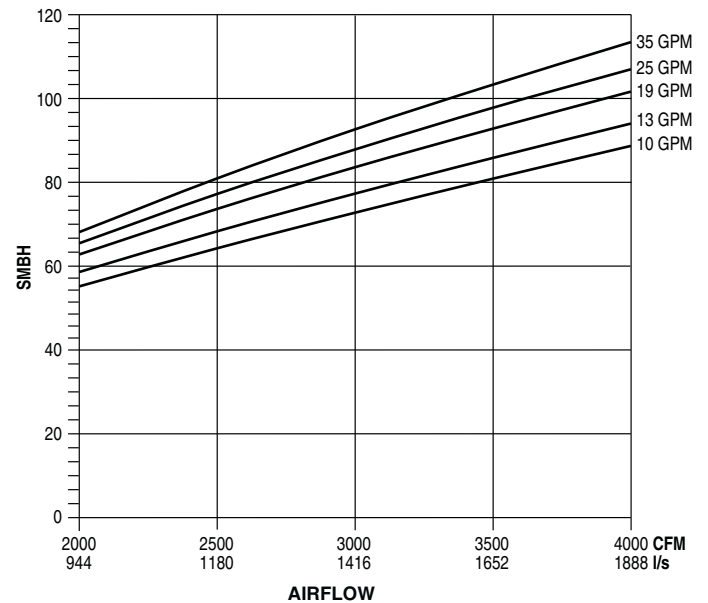

### Altitude Correction Factors

Altitude (ft.)	0	1000	2000	3000	4000	5000	6000	7000
Air Density (lb./cu.ft)	0.075	0.072	0.070	0.067	0.065	0.063	0.060	0.058
Total Capacity	1000	0.988	0.986	0.983	0.981	0.979	0.977	0.975
Sensible Capacity	1000	0.960	0.930	0.900	0.860	0.830	0.800	0.770
Static Pressure	1000	0.960	0.930	0.900	0.860	0.830	0.800	0.770

### NOTES:

- Capacity and static pressure will be affected for applications above sea level. To apply correction factors, multiply the coil capacity or fan curve data by the tabulated correction factor.
- Connections: 5 and 6 Row 1 1/8" (28.6) O.D. male solder.

B

HORIZONTAL FAN COIL UNITS • DUCTED

## Model Series 35FH • Hot Water Coil Performance Data

### Unit Sizes 4 – 8

Data Based on 70°F DB Entering Air & 180°F Entering Water

1 Row (Total MBH)

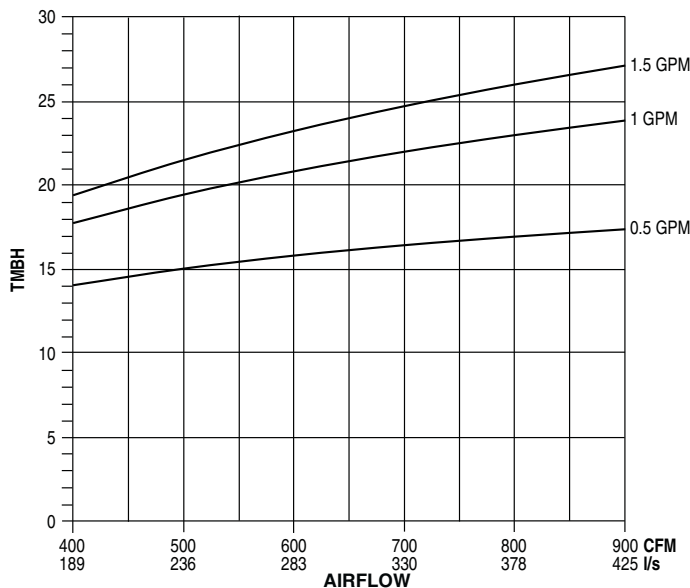

2 Row (Total MBH)

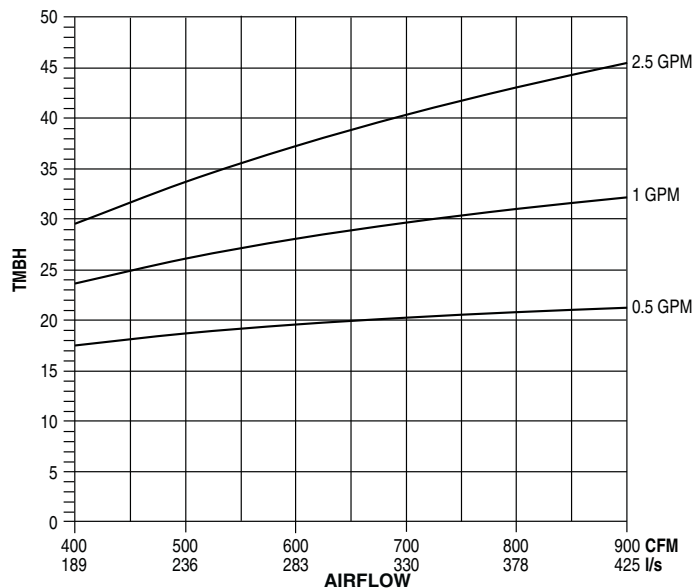

### Unit Sizes 10 – 16

1 Row (Total MBH)

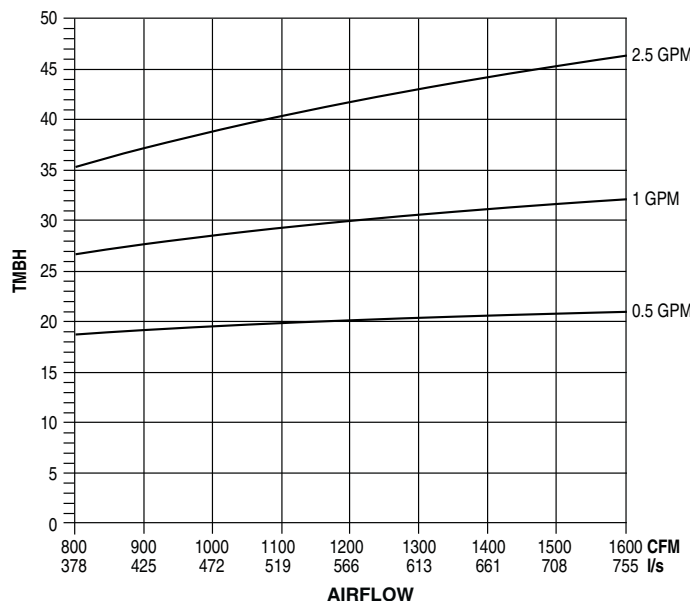

2 Row (Total MBH)

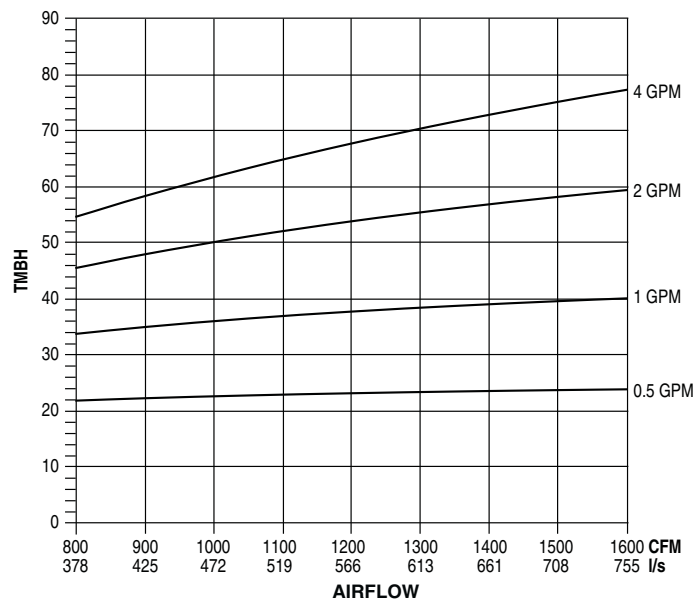

#### NOTES:

- Capacities are in MBH (kW), *thousands of Btu per hour (kiloWatts)*.
- MBH (kW) values are based on a  $\Delta t$  (temperature difference) of 110°F (61°C) between entering air and entering water. For other  $\Delta t$ 's; multiply the MBH (kW) values by the factors below.

- Air Temperature Rise.

$$\text{ATR (}^\circ\text{F)} = 927 \times \frac{\text{MBH}}{\text{CFM}}, \text{ ATR (}^\circ\text{C)} = 829 \times \frac{\text{kW}}{\text{l/s}}$$

- Water Temp. Drop.

$$\text{WTD (}^\circ\text{F)} = 2.04 \times \frac{\text{MBH}}{\text{GPM}}, \text{ WTD (}^\circ\text{C)} = .224 \times \frac{\text{kW}}{\text{l/s}}$$

- Connections: One and two row 5/8" (15.9) O.D. male solder.

#### Altitude Correction Factors:

Altitude ft. (m)	Sensible Heat Factor
0 (0)	1.00
2000 (610)	0.94
3000 (914)	0.90
4000 (1219)	0.87
5000 (1524)	0.84
6000 (1829)	0.81
7000 (2134)	0.78

#### Correction factors at other entering conditions:

$\Delta t$ °F (°C)	50 (28)	60 (33)	70 (39)	80 (44)	90 (50)	100 (56)	110 (61)	120 (67)	130 (72)	140 (78)	150 (83)
Factor	.455 (.459)	.545 (.541)	.636 (.639)	.727 (.721)	.818 (.820)	.909 (.918)	1.00 (1.00)	1.09 (1.10)	1.18 (1.18)	1.27 (1.28)	1.36 (1.36)

## Model Series 35FH • Hot Water Coil Performance Data

### Unit Sizes 18 – 24

Data Based on 70°F DB Entering Air & 180°F Entering Water

1 Row (Total MBH)

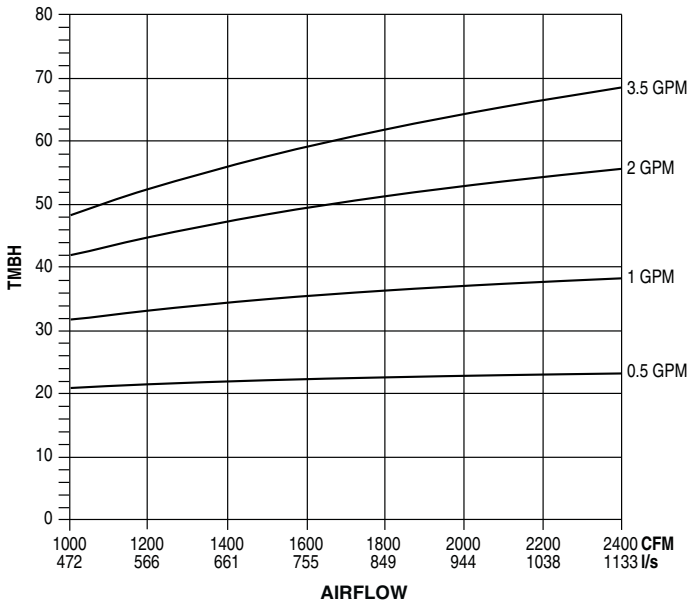

2 Row (Total MBH)

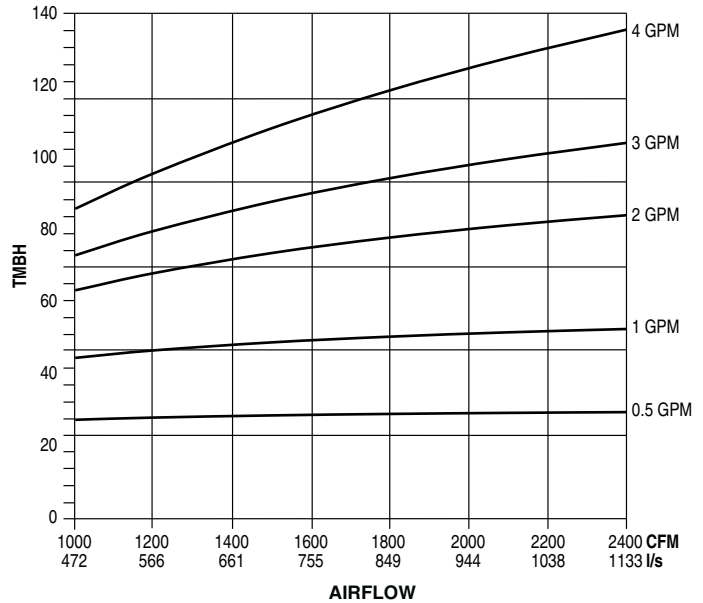

### Unit Size 30

1 Row (Total MBH)

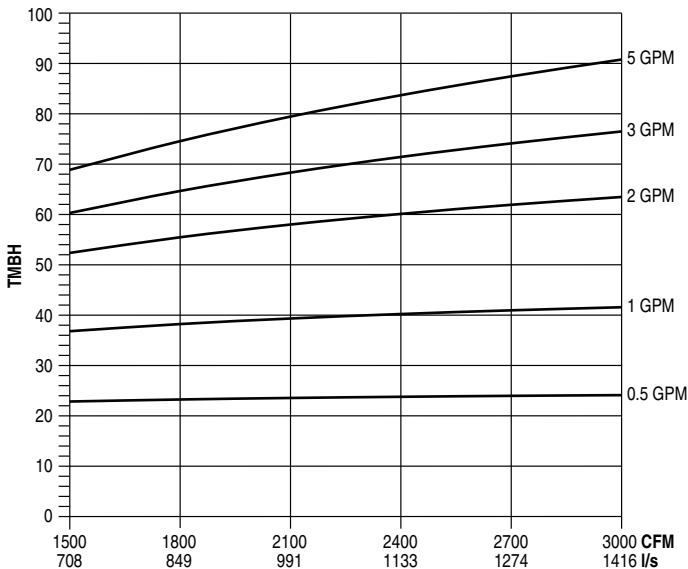

2 Row (Total MBH)

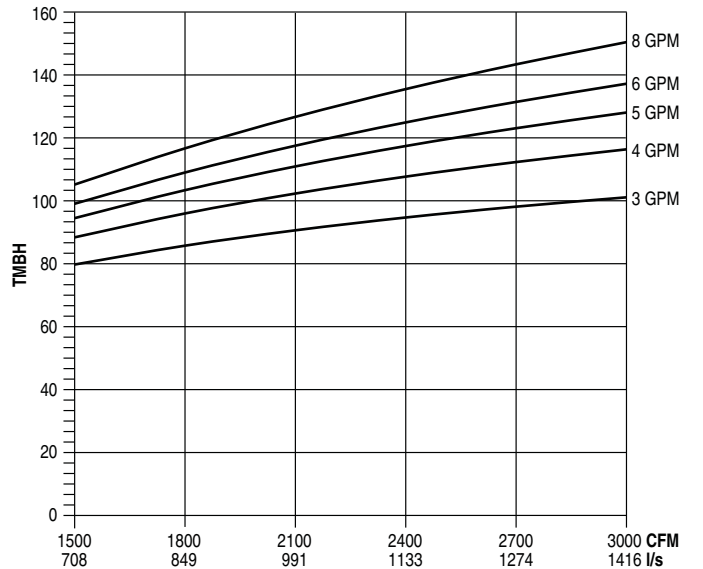

**NOTES:**

- Capacities are in MBH (kW), *thousands of Btu per hour (kiloWatts)*.
- MBH (kW) values are based on a  $\Delta t$  (temperature difference) of 110°F (61°C) between entering air and entering water. For other  $\Delta t$ 's; multiply the MBH (kW) values by the factors below.

- Air Temperature Rise.  
 $ATR (^\circ F) = 927 \times \frac{MBH}{CFM}$ ,  $ATR (^\circ C) = 829 \times \frac{kW}{I/s}$
- Water Temp. Drop.  
 $WTD (^\circ F) = 2.04 \times \frac{MBH}{GPM}$ ,  $WTD (^\circ C) = .224 \times \frac{kW}{I/s}$
- Connections: One and two row 5/8" (15.9) O.D. male solder.

**Altitude Correction Factors:**

Altitude ft. (m)	Sensible Heat Factor
0 (0)	1.00
2000 (610)	0.94
3000 (914)	0.90
4000 (1219)	0.87
5000 (1524)	0.84
6000 (1829)	0.81
7000 (2134)	0.78

**Correction factors at other entering conditions:**

$\Delta t$ °F (°C)	50 (28)	60 (33)	70 (39)	80 (44)	90 (50)	100 (56)	110 (61)	120 (67)	130 (72)	140 (78)	150 (83)
Factor	.455 (.459)	.545 (.541)	.636 (.639)	.727 (.721)	.818 (.820)	.909 (.918)	1.00 (1.00)	1.09 (1.10)	1.18 (1.18)	1.27 (1.28)	1.36 (1.36)

B HORIZONTAL FAN COIL UNITS • DUCTED

## Model Series 35FH • Hot Water Coil Performance Data Unit Size 40

Data Based on 70°F DB Entering Air & 180°F Entering Water

1 Row (Total MBH)

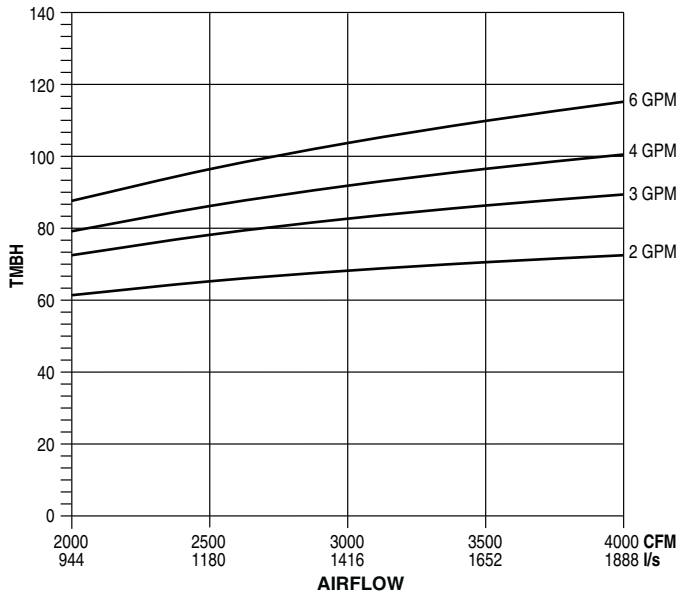

2 Row (Total MBH)

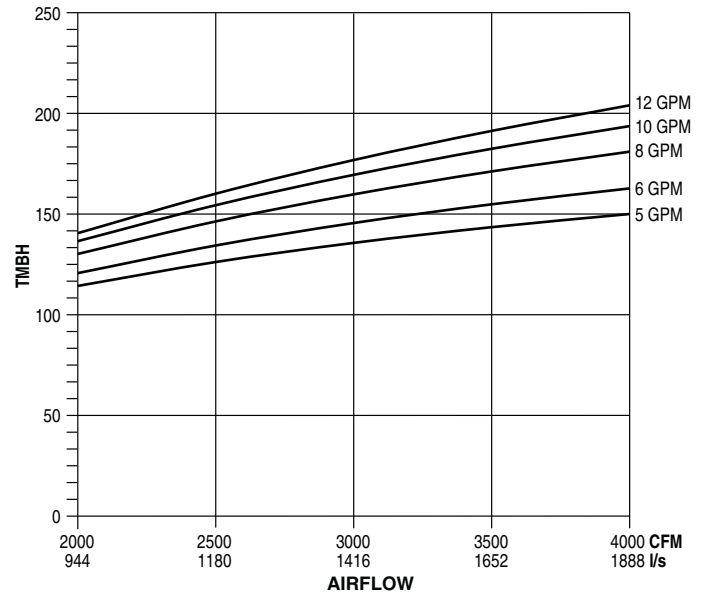

**NOTES:**

- Capacities are in MBH (kW), *thousands of Btu per hour (kiloWatts)*.
- MBH (kW) values are based on a Δt (temperature difference) of 110°F (61°C) between entering air and entering water. For other Δt's; multiply the MBH (kW) values by the factors below.

- Air Temperature Rise.

$$ATR (°F) = 927 \times \frac{MBH}{CFM}, \quad ATR (°C) = 829 \times \frac{kW}{l/s}$$

- Water Temp. Drop.

$$WTD (°F) = 2.04 \times \frac{MBH}{GPM}, \quad WTD (°C) = .224 \times \frac{kW}{l/s}$$

- Connections: One and two row 5/8" (15.9) O.D. male solder.

**Altitude Correction Factors:**

Altitude ft. (m)	Sensible Heat Factor
0 (0)	1.00
2000 (610)	0.94
3000 (914)	0.90
4000 (1219)	0.87
5000 (1524)	0.84
6000 (1829)	0.81
7000 (2134)	0.78

**Correction factors at other entering conditions:**

Δt °F (°C)	50 (28)	60 (33)	70 (39)	80 (44)	90 (50)	100 (56)	110 (61)	120 (67)	130 (72)	140 (78)	150 (83)
Factor	.455 (.459)	.545 (.541)	.636 (.639)	.727 (.721)	.818 (.820)	.909 (.918)	1.00 (1.00)	1.09 (1.10)	1.18 (1.18)	1.27 (1.28)	1.36 (1.36)

**B**

HORIZONTAL FAN COIL UNITS • DUCTED

## Model Series 35FH • Coil Performance Data • Pressure Drop Unit Sizes 4 – 8

**Chilled Water Pressure Drop**

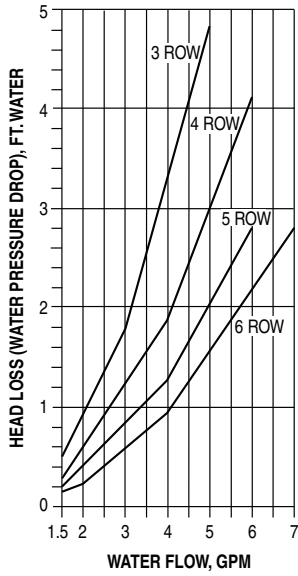

**Hot Water Pressure Drop**

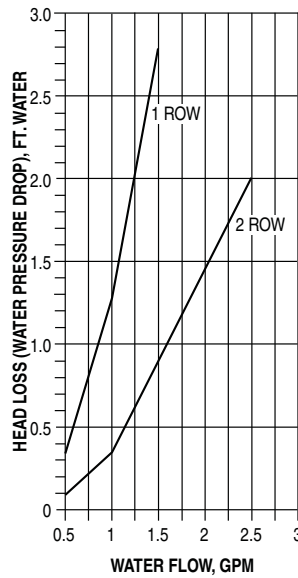

**Chilled and Hot Water Air Pressure Drop**

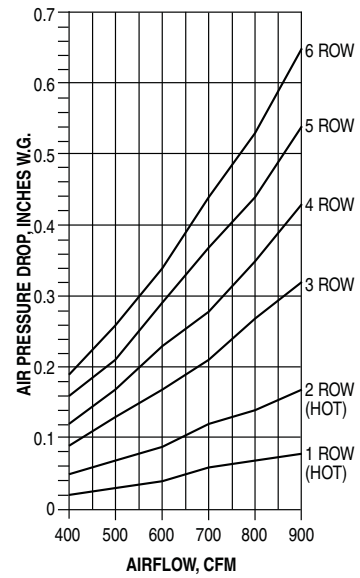

## Unit Sizes 10 – 16

**Chilled Water Pressure Drop**

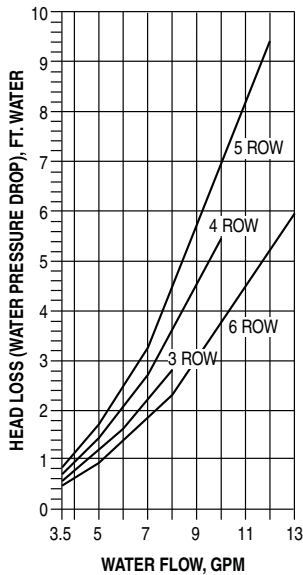

**Hot Water Pressure Drop**

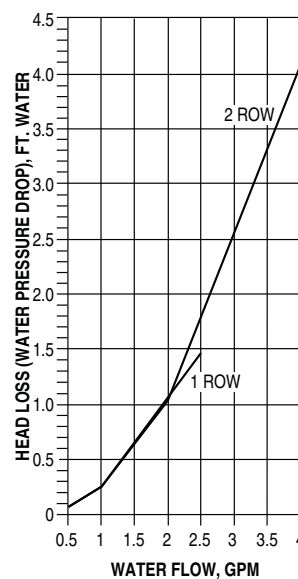

**Chilled and Hot Water Air Pressure Drop**

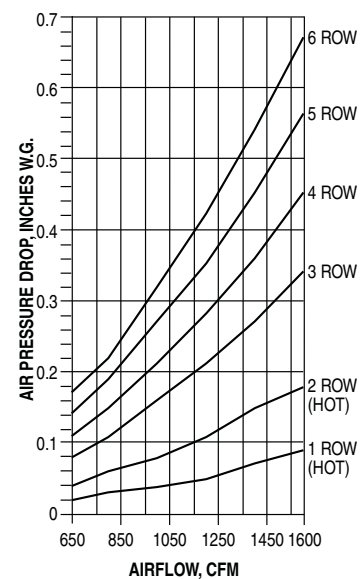

**Metric Conversion Factors:**

- Water Flow (liters per second)  
 $l/s = gpm \times 0.6309$
- Water Head Loss (kilopascals):  
 $kPa = ft. w.g. \times 2.9837$
- Airflow Volume (liters per second)  
 $l/s = CFM \times 0.472$
- Air Pressure Drop (Pascals):  
 $Pa = in. w.g. \times 248.6$
- Heat (kilowatts):  
 $kW = Mbh \times 0.293$

**B**

**HORIZONTAL FAN COIL UNITS • DUCTED**

## Model Series 35FH • Coil Performance Data • Pressure Drop Unit Sizes 18 – 24

**Chilled Water Pressure Drop**

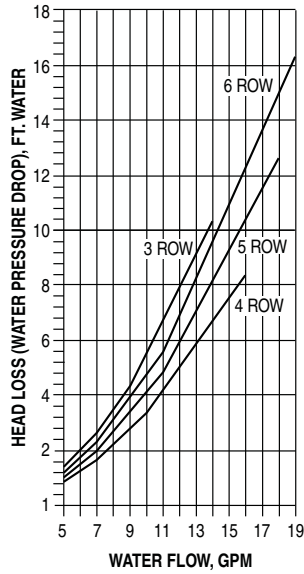

**Hot Water Pressure Drop**

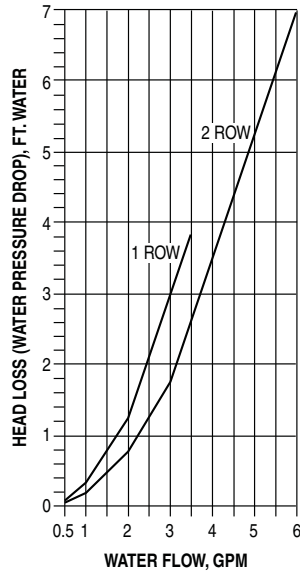

**Chilled and Hot Water Air Pressure Drop**

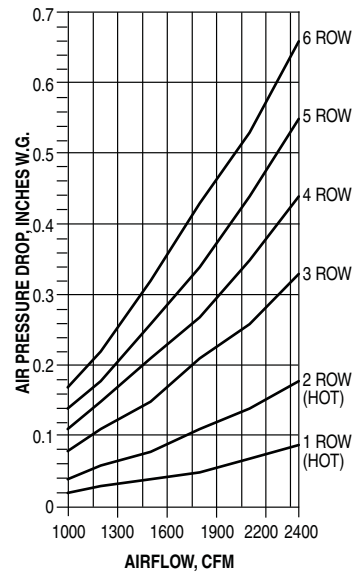

## Unit Size 30

**Chilled Water Pressure Drop**

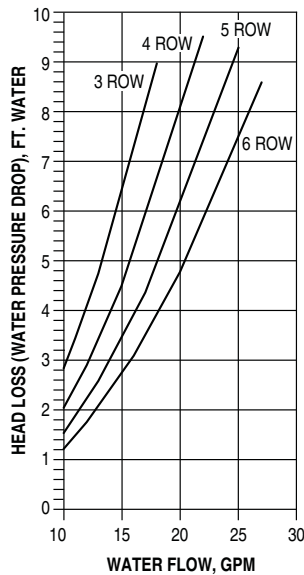

**Hot Water Pressure Drop**

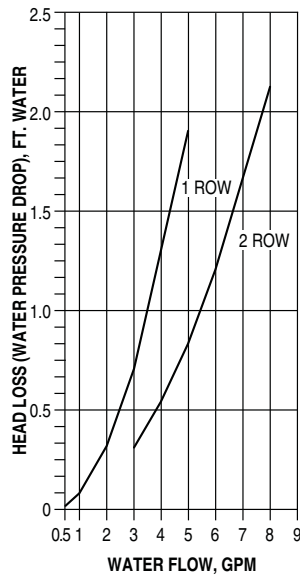

**Chilled and Hot Water Air Pressure Drop**

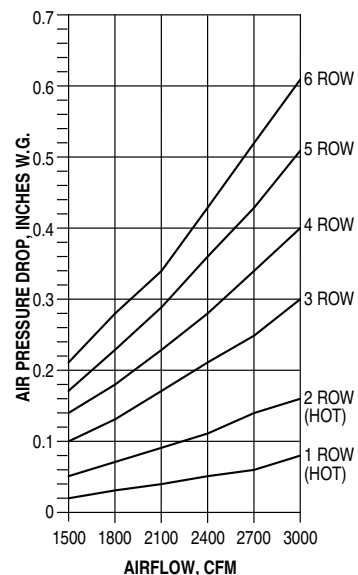

**Metric Conversion Factors:**

1. Water Flow (liters per second)  
l/s = gpm x 0.6309
2. Water Head Loss (kilopascals):  
kPa = ft. w.g. x 2.9837
3. Airflow Volume (liters per second)  
l/s = CFM x 0.472
4. Air Pressure Drop (Pascals):  
Pa = in. w.g. x 248.6
5. Heat (kilowatts):  
kW = Mbh x 0.293



## Model Series 35FH • Coil Performance Data • Pressure Drop Unit Size 40

### Chilled Water Pressure Drop

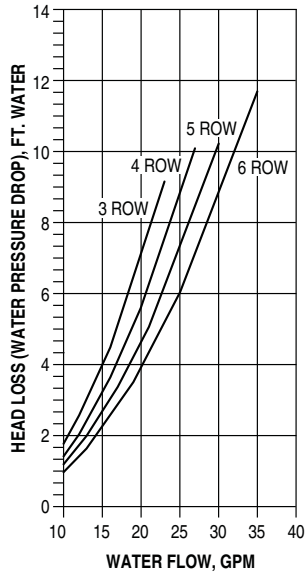

### Hot Water Pressure Drop

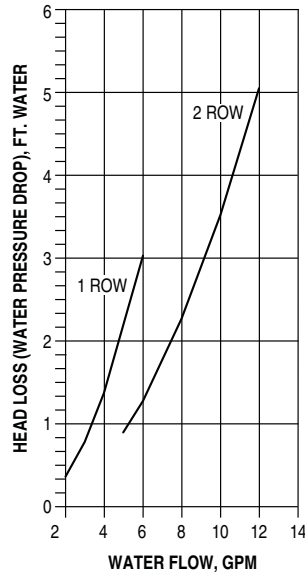

### Chilled and Hot Water Air Pressure Drop

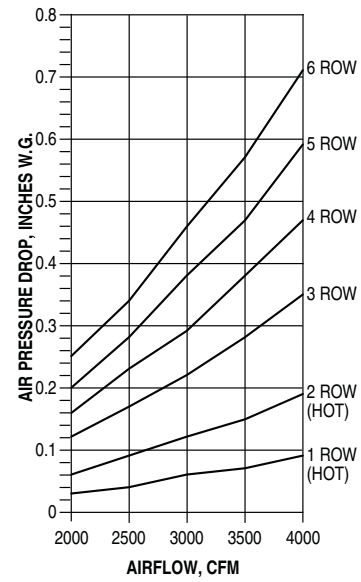

### Metric Conversion Factors:

- Water Flow (liters per second)  
 $l/s = \text{gpm} \times 0.6309$
- Water Head Loss (kilopascals):  
 $\text{kPa} = \text{ft. w.g.} \times 2.9837$
- Airflow Volume (liters per second)  
 $l/s = \text{CFM} \times 0.472$
- Air Pressure Drop (Pascals):  
 $\text{Pa} = \text{in. w.g.} \times 248.6$
- Heat (kilowatts):  
 $\text{kW} = \text{Mbh} \times 0.293$

B

HORIZONTAL FAN COIL UNITS • DUCTED

## Model Series 35FH • Suggested Specifications

1. General
 

Furnish and install Engineered Comfort Model 35FH Series High Performance Horizontal Fan Coil Units where indicated on the plans and in the specifications.
2. Construction
  - a. All units shall be Direct Drive – Draw Through configuration and completely factory assembled, tested and shipped as one piece. All units shall be capable of meeting or exceeding the scheduled capacities for cooling, heating and air delivery. All unit dimensions, for each model and size, shall be considered maximums. Units shall be UL or ETL, listed in compliance with UL 1995, and be certified as complying with the latest edition of AHRI Standard 440. Must meet the requirements of NFPA 90A and UL 181.
  - b. All unit chassis shall be fabricated of heavy gauge galvanized steel panels able to meet 125-hour salt spray test per ASTM B-117. 18 ga. (1.31) galvanized steel channel frame. All panels surrounding the coil shall be insulated with 3/4" (19) thick closed cell fiber-free and rated for air velocity of 6000 f.p.m. Insulation must meet all requirements of ASTM C1071 (including C665), UL 181 for erosion, and carry a 25/50 rating for flame spread/smoke developed per ASTM E-84, UL 723 and NFPA 90A. All other panels, surrounding the units, must also be acoustically and thermally insulated with a minimum of 3/4" (19) insulation with dual density insulation fiber glass insulation where all exposed edges are coated to prevent air erosion.
  - c. Unit cabinet shall have side and bottom full size access panels for ease of maintenance and service and motor blower removal. Access panels shall be attached to casing with screws.

Optional

  - Aluminum foil-faced insulation (steri-liner), meets ASTM Standards C-665 and C-1136 for biological growth in insulation. All exposed edges shall be sealed to prevent any fibers from reaching the air stream.
  - Close cell fiber-free liner. Insulation shall conform to UL 181 for erosion and NFPA 90A for fire, smoke and melting, and comply with a 25/50 Flame Spread and Smoke Developed Index per ASTM E-84 or UL 723. Additionally, insulation shall comply with Antimicrobial Performance Rating of 0, no observed growth, per ASTM G-21.
  - Perforated metal with steri-liner.
4. Casing leakage shall not exceed 2% of rated airflow @ .5" w.g. (125 Pa).
5. Unit shall be draw through type with fan dynamically balanced, forwardly curved; DWDI centrifugal type constructed of 18 gauge (1.31) zinc coated galvanized steel for corrosion resistance. The fan assembly shall be easily removable for servicing the motor and blower at, or away from the unit. The entire fan assembly shall be able to come out of the unit by removing four nuts per fan and disconnecting the motor(s) wires.
6. Motor shall be direct drive, isolated from blower and fan housing in at least four (4) locations with rubber isolators to eliminate any motor vibration being transmitted to the fan housing and duct. Motor shall be capable to be serviced through the bottom or side panel. Provide isolation between fan motor assembly and unit casing in at least four (4) locations to eliminate any vibration from the fan to the terminal unit casing. Motors shall be high efficiency, permanently lubricated sleeve bearing. Single speed motors are not acceptable. Motor wires shall be brought into external hinged door control enclosure to facilitate wiring and service. Motors shall be of the Permanent Split Capacitor type with UL and CSA listed automatic reset thermal overload protection and three separate horsepower taps.
 

Optional

  - Electronically Commutated Motor (ECM) with "EPIC Fan Technology", factory-programmed and run-tested in assembled units with 3 speeds. Motor controller is mounted in a control box with a built-in integrated user interface. If adjustments are needed, motor parameters can be adjusted without factory service personnel at the motor control board. Motors will soft-ramp between speeds to minimize the acoustics due to sudden speed changes. Motors can be operated at either one, two or three speeds or with a factory or field-supplied variable speed controller. All motors have integral thermal overload protection with a maximum ambient operating temperature of 104°F (40°C). Motors are capable of starting at 50 percent of rated voltage and operating at 90 percent of rated voltage on all speed settings. Motors can operate up to 10 percent over voltage.
  - Electronically Commutated Motor (ECM) with "EPIC Fan Technology", factory-programmed and run-tested in assembled units with fully variable speed capability. The motor designed for use with single phase power shall have a controller mounted in a control box with a built-in integrated user interface. If adjustments are needed, motor parameters can be adjusted without factory service personnel at the motor control board. Motors shall soft-ramp to programmed specific to minimize the acoustics due to sudden speed changes. Motors can be operated at the established range of airflows with a factory or field-supplied variable speed controller. All motors have integral thermal overload protection with a maximum ambient operating temperature of 104°F (40°C). Motors are capable of starting at 50 percent of rated voltage and operating at 90 percent of rated voltage on all speed settings. Motors can operate up to 10 percent over voltage.
7. Sound
 

Units shall have discharge and radiated sound power levels published and tested in accordance with AHRI Standard 880.
8. Coils
  - a. All water coils shall be AHRI 410 certified and tagged with an AHRI 410 label. All coils shall be pressure tested under water at 1.5 times the working pressure classification indicated in the Contract Documents, but the test pressure in no case shall be less than 300 psig. Coils shall have 1/2" O.D. seamless copper tubes, and collared and corrugated aluminum fins. Tube wall thickness of 0.016 to be standard. Coil frames shall be constructed of minimum G-90 galvanized steel. Water velocity in the tubes shall not exceed eight (8) feet per second and the coil face velocity shall not exceed 500 fpm (2.54 m/s).
  - b. For 4-pipe system a separate heating coils shall be furnished in the reheat position as standard.
  - c. Coils, header and drain pan shall be provided in a fully insulated integral casing with 3/4" (19) fiber-free/foam insulation to increase thermal efficiency and reduce casing leakage.

Optional

  - For 4-pipe system a separate heating coils shall be furnished in the preheat position as standard.
  - Coil tube wall thickness of 0.025" (0.635).
  - All coils with piping packages shall be provided with a manual air vent fitting to reduce potential air locks within coil.
  - All coils shall be provided with an auto air vent fitting to allow for coil venting.
9. Drain Pans
  - a. Primary condensate drain pans shall be heavy gauge galvanized steel, and extend under the entire cooling coil. Drain pans shall be of one-piece construction, have at least 1" (25) height side and be positively sloped for condensate removal.
  - b. The drain pan shall be externally insulated with minimum 3/8" (10) thick fire retardant, closed cell foam insulation. The insulation shall carry no more than a 25/50 Flame Spread and Smoke Developed Rating per ASTM E-84 and UL 723 and an Antimicrobial Performance Rating of "0", no observed growth, per ASTM G-21.

## Model Series 35FH • Suggested Specifications (continued)

### Optional

- Provide a primary drain pan constructed entirely of heavy gauge stainless steel for superior corrosion resistance. Stainless steel drain pans shall be externally insulated and meet or exceed the requirements stated above.
- Provide a secondary drain connection on the primary drain pan for condensate overflow.
- Provide a condensate overflow switch in the primary drain pan for condensate overflow.

### 10. Standard units can be ordered without filters.

#### Optional Filter

- Unit to be furnished with a minimum 1" (25) nominal glass fiber throwaway filter. Filters shall be tight fitting to prevent air bypass.
- Provide unit with 2" (51) pleated filters rated at 25-30% efficiency and MERV 8 or 13 based on ASHRAE 52.2
- Unit shall be furnished with the FFR Ducted Filter Rack to facilitate the installation of inlet duct. FFR Filter Rack shall have hinged door flap with latch on the side and bottom to facilitate filter replacement.

### 11. Electrical

Units shall be furnished with a hinged door control enclosure and wired single point power connection. All power and control wiring shall conform to National Electric Code Standards. Within the control enclosure it shall include all required devices, including but not limited to, service switch, relay, control power transformers and control packages, low voltage remote shutdown relays, etc.

### 12. Electric heat

- Furnish an electric resistance heating assembly as an integral part of the fan coil unit, with the heating capacity, voltage and kilowatts scheduled. The heater assembly shall be designed and rated for installation on the fan coil unit and be located in the unit as to not expose the fan assembly to excessive leaving air temperatures that could affect motor performance.
- The heater and unit assembly shall be listed for zero clearance and meet all NEC requirements, and be ETL listed with the unit as an assembly in compliance with UL 1995. A NEMA 1 enclosure with hinges shall be placed at the side of the fan coil to provide easy access. All motor wiring and heater terminates in the enclosure for single point electrical connection.
- All heating elements shall be open coil high grade Class A 80/20 nickel/chrome element wire mounted in ceramic insulators and located in an insulated heavy gauge galvanized steel housing. All elements shall terminate in a machine staked stainless steel terminal secured with stainless steel hardware for corrosion resistance. The element support brackets shall be spaced no greater than 3 1/2" (89) on center. All internal wiring shall be rated for 219°F (105°C) minimum. All heaters shall include over temperature protection consisting of an automatic reset primary thermal limit. All heaters shall be single stage unless noted otherwise on the plans. All units with electric heat shall be provided with an incoming line power distribution block, designated to accept single point power wiring capable of carrying 125% of the calculated load current.
- A Class 2 transformer shall be provided for low voltage control. All devices shall be serviceable through the hinged enclosure and without removing heating element from the unit.

### Optional

- Heating coils shall be controlled with the SCR option and proportional control to provide infinite heater control.
- 2 Stage Electric Heat shall be provided.
- Toggle Disconnect.
- Door Interlocking disconnect switch.
- Quieter operation option available.
- Power circuit fusing.

### Dust tight control enclosure.

- Manual reset secondary high limit.
- Positive pressure airflow switch.
- Electronic air proofing with EPIC ECM.

### 13. Piping – Valve Packages

#### As optional

- Provide a factory assembled and installed valve piping package in a fully insulated integral casing with 3/4" (19) fiber-free/foam insulation to increase thermal efficiency and reduce casing leakage. Valve package shall consist of a 2 or 3 way, on/off, motorized electric control valve and two ball isolation valves. Maximum entering water temperature on the control valve shall be 200°F (93.3°C) with a maximum operating pressure of 300 PSIG. Refer to Specification Section titled, "Pipes, Valves, Fittings and Accessories" for optional and accessories specifications.
- Provide modulating control valve (fail-in-place) in lieu of standard 2-position control valve with factory assembled valve piping package.
- Provide a fixed-auto flow control device for each piping package with the specific gpm specified for the unit on the schedule.
- Provide an adjustable flow control device for each piping package.
- Provide unions and/or pressure/temperature ports for each piping package.

### 14. Ultraviolet Light

As optional each unit shall be supplied with Ultraviolet Lights for disinfection for HVAC mold, bacteria & odor control. Fixture assembly to be installed at the coil discharge (downstream of the coil), between the coil and fan housing. Fixtureless lamps are to be installed in sufficient quantity and in such a manner so as to provide an equal distribution of UVC energy. The minimal UVC energy striking a surface shall be sufficient to continuously destroy a monolayer of mold and bacteria in less than six hours when at 55-135°F (12.7-57°C). Fixture shall be electrically terminated to within factory supplied ballast housings to meet NEC and local codes. Lamps shall be mounted to irradiate the intended surface(s) as well as all of the available line of sight airstream by proper placement and incident angle reflection.

To protect maintenance personnel, all access panels and doors to the UVC assembly and/or within view of the UVC assembly must include mechanical interlock switch(es) to insure that the UVC assembly will be de-energized when any of these accesses are opened.

For complete safety, the UVGI equipment shall have been tested, Listed and labeled as an integral part of the fan coil unit by the fan coil manufacturer, no exceptions.

### 15. Controls

Controller and sensors provided by others but mounted and wired during unit assembly at the fan coil manufacturing facility.

## Model Series 37FH • Low Profile • Direct Drive Draw-through Design

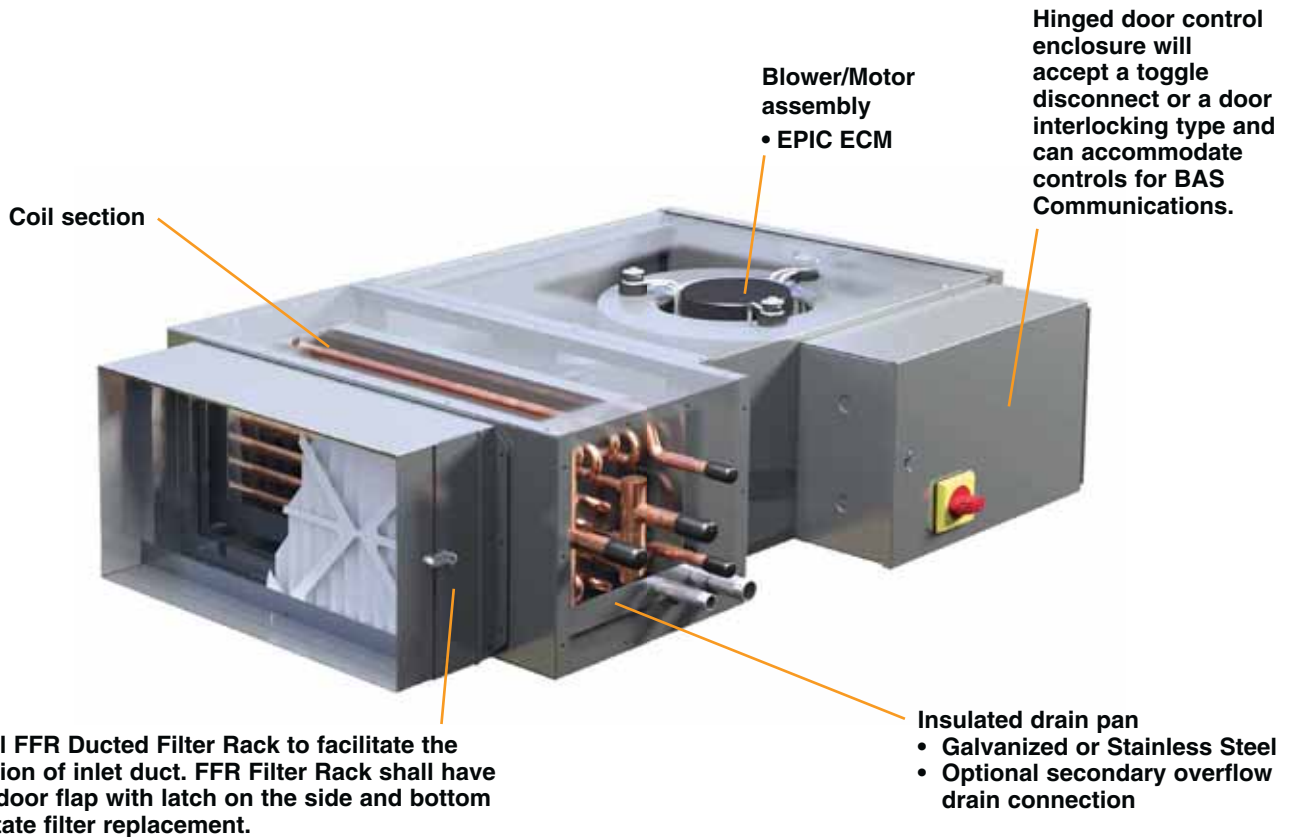
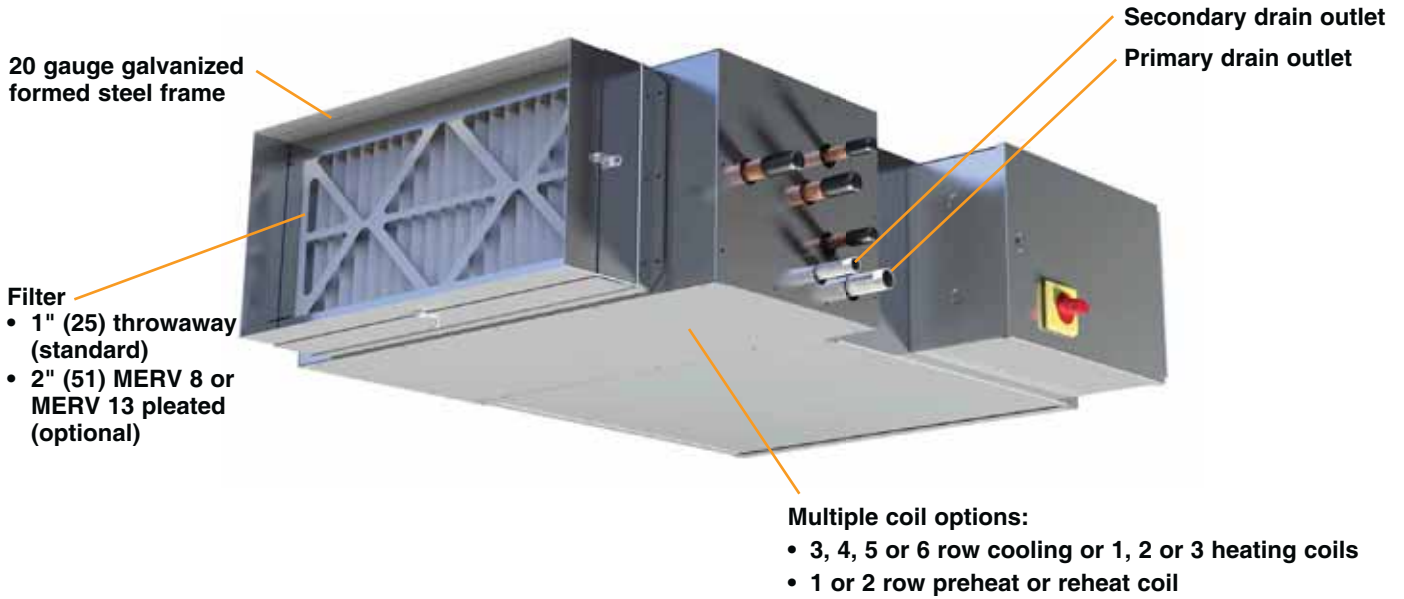

37FHZW

**B**  
HORIZONTAL HIGH CAPACITY - DUCTED

## Model Series 37FH • Low Profile • Direct Drive Draw-through

The Engineered Comfort Low Profile Direct Drive draw-through 37FH Series, a fully commercial unit designed for concealed ceiling applications where a lower profile is required [11" (279) high unit].

### BENEFITS:

- Airflow capacities from 100 – 1400 CFM (47 – 661 l/s).
  - Insulated inlet casing reduces radiated sound.
  - Only 11" (279) in height for tight ceiling applications.
  - Various IAQ linings available.
  - Optional Outside Air Inlet provides a greater indoor quality.
- Sound power levels tested and published in accordance with ASHRAE 130/AHRI 880.

AHRI certified units available as:

2-pipe System:

- Type W: 1, 2 or 3 row coil for heating only.
- Type Z: 3, 4, 5 or 6 row coil for cooling or heating.

4-pipe system:

- Type ZW: 3, 4 or 5 row cooling coil and 1 or 2 row heating coil.
- Either as reheat or preheat.

Contact Nailor's representative for steam heating or direct expansion application.

### Standard and Features

#### CONSTRUCTION

- 20 ga. (1.00) galvanized steel casing components.
- 1" (25) throwaway filter.
- 1/2" (13) dual density fiberglass liner, exposed edges coated to prevent air erosion. Meets the requirements of NFPA 90A and UL 181.
- Top and bottom full size access panels for ease of maintenance and service.
- Ultra-energy efficient ECM fan motor with overload protection. Solid state EPIC fan volume controller.
- Motor blower assembly mounted on special 16 ga. (1.61) angles and isolated from casing with rubber isolators.
- Single point electrical connection.
- Discharge opening designed for flanged duct connection.
- Controls mounted as standard on RH side as shown. Fan Coil ordered with LH controls (optional) are inverted and discharge duct hanging location will change.

#### FAN/MOTOR ASSEMBLIES

- Forward Curved, DWDI, direct driven blowers.
- Blower/motor assembly isolated from fan housing with vibration isolators.
- Motor power leads with quick disconnect brought into an external hinged door starter-control enclosure.
- 120, 208, 240 and 277 volt single phase motor.

#### WATER COILS

- Installed on inlet as a draw-through design.
- Coil (and header on multi-circuit units) is installed in insulated (fiber-free/foam) casing for increased thermal efficiency.
- 1/2" (13) copper tubes with aluminum ripple fins.
- Cooling coils include an insulated, galvanize steel drain pan with 3/4" (19) male NPT primary drain connection.
- Top and bottom access panels for inspection and coil cleaning.
- Right hand coil connection shown (looking in direction of airflow) is standard. Left hand is optional.

#### ELECTRICAL COILS

- Hinged door with heater element module for easy access, removal and replacement of heater element without disturbing ductwork.
- Coil installed on unit discharge.
- Insulated coil element wrapper.
- Automatic reset high limit cut-outs (one per element).
- Flanged outlet duct connection.



## Model Series 37FH • Low Profile • Direct Drive Draw-through



37FHZW with EPIC ECM Motor, Optional Outside Air Inlet, Optional Controls Enclosure and Optional Ducted Filter Rack Connection

### Options and Accessories

#### CONSTRUCTION

##### Insulation

- 1/2" (13) Steri-Liner (Foil Face).
- Fiber-free Liner (closed cell foam).
- 1" (25) or 2" (51) Filter Rack
- 1" (25) Throwaway filter with spare.
- 2" (51) MERV 8 / MERV 13.
- 2" (51) MERV 8 / MERV 13 with spare

#### COILS

- Manual or Automatic air vent(s) with valve package.
- Coil Casing 20 ga. (1.00) stainless steel drain pan externally insulated with fiber-free foam.
- Stainless steel coil casing.
- Increased tube wall thickness 0.025" (0.635).

#### DRAIN PANS

- Stainless Steel drain pan externally insulated with fiber-free foam.
- 5/8" (15.9) Secondary (overflow) drain connection with or without overflow safety switch.

#### CONTROL PACKAGES

- Toggle Disconnect Switch.
- Door Interlocking disconnect switch.
- Main Unit Fusing.
- Drain Pan Float Switch (24V).
- 24V transformer and fan relay packages.
- Factory installed controls – provided by others.

#### VALVE-PIPING PACKAGES

- Factory assembled and Installed in enclosure or field installed.
- 1/2" or 3/4" (13 or 19) 2 or 3 way valves.
- On/Off, 24V, modulating 0–10 vdc.
- Ball valves, Unions, P/T ports and Shut-off valves.
- Circuit setters (manual or auto-fixed flow control).
- Strainers and Strainer with hose bib valve.
- P/T ports and Bypass balancing valve.

#### OTHER OPTIONS

- Ultraviolet light w/safety switch.
- Ducted return filter rack connection (FFR).
- Outside Air Inlet (OAI).
- Duct tight controls enclosure.
- Condensate pump.

## Model Series 37FH • Direct Drive Draw-through • EPIC ECM 2 Pipe or 4 Pipe • Unit Sizes 5 & 8

### MODELS:

- 37FHZ** Chilled/Hot water (2-pipe).
- 37FHZW** Chilled & hot water (4-pipe).

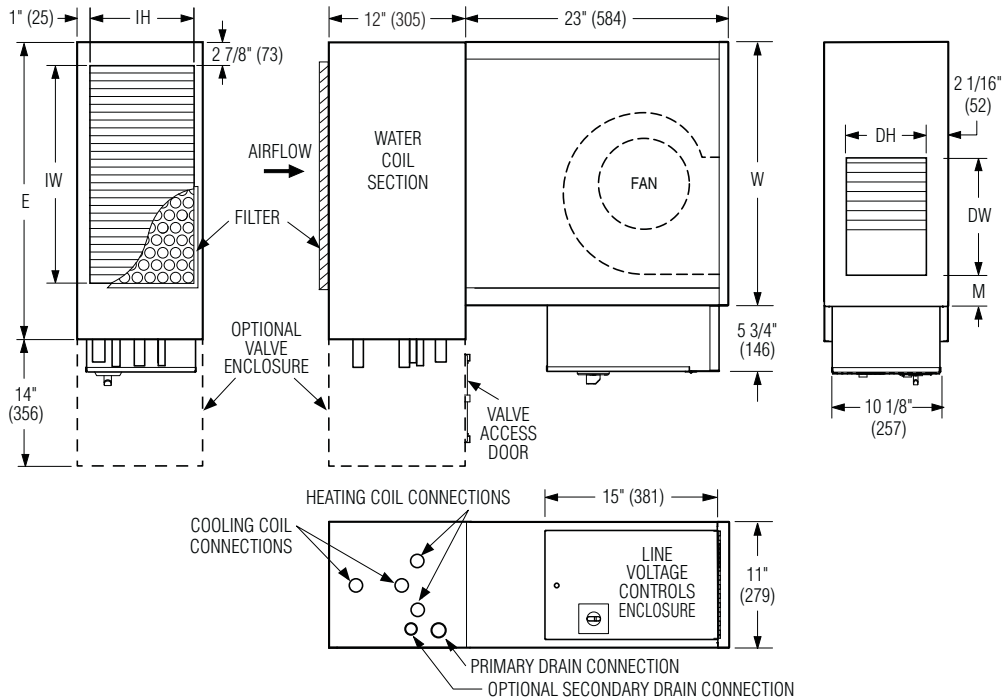

### Dimensional Data

Unit Size	Nominal CFM (l/s)	W	E	Inlet IW x IH	Outlet Discharge DW x DH	M	Filter Size W x H
5	500 (236)	23 (584)	26 (660)	19 x 8 3/4 (483 x 222)	10 1/4 x 6 3/4 (260 x 171)	2 3/4 (70)	20 x 10 (508 x 254)
8	800 (378)	37 (940)	40 (1016)	33 x 8 3/4 (838 x 222)	11 1/4 x 6 3/4 (286 x 171)	10 5/8 (270)	35 x 10 (889 x 254)



**B**

**HORIZONTAL HIGH CAPACITY - DUCTED**



## Model Series 37FH • Direct Drive Draw-through • EPIC ECM 2 Pipe or 4 Pipe • Unit Size 12

### MODELS:

- 37FHZ** Chilled/Hot water (2-pipe).
- 37FHZW** Chilled & hot water (4-pipe).

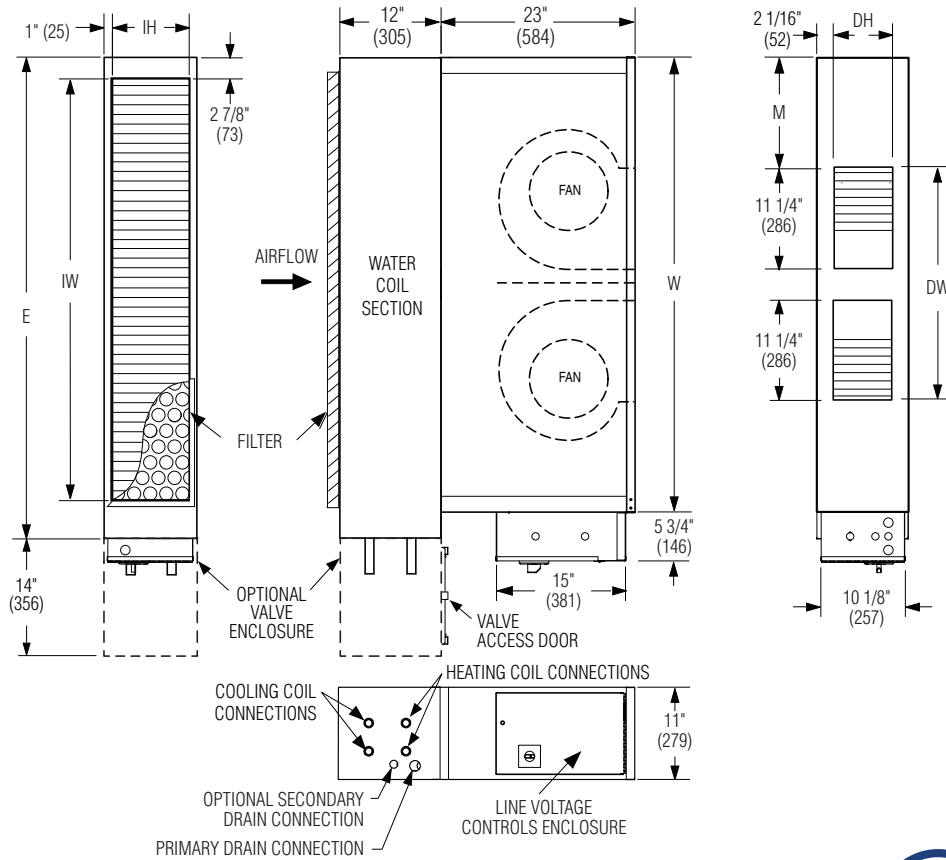

### Dimensional Data

Unit Size	Nominal CFM (l/s)	W	E	IW x IH	Outlet Discharge DW x DH	M	Filter Size W x H
12	1200 (566)	54 (1372)	57 (1448)	50 x 8 3/4 (1270 x 222)	26 3/4 x 6 3/4 (679 x 171)	13 5/8 (346)	52 x 10 (1321 x 254)



**B** HORIZONTAL HIGH CAPACITY - DUCTED

## Model Series 37FH • Direct Drive Draw-through • EPIC ECM 2 Pipe with Electric Heat • Unit Sizes 5 & 8

### MODEL:

37FHZE Chilled/Hot water and Electric Heat

B

HORIZONTAL HIGH CAPACITY - DUCTED

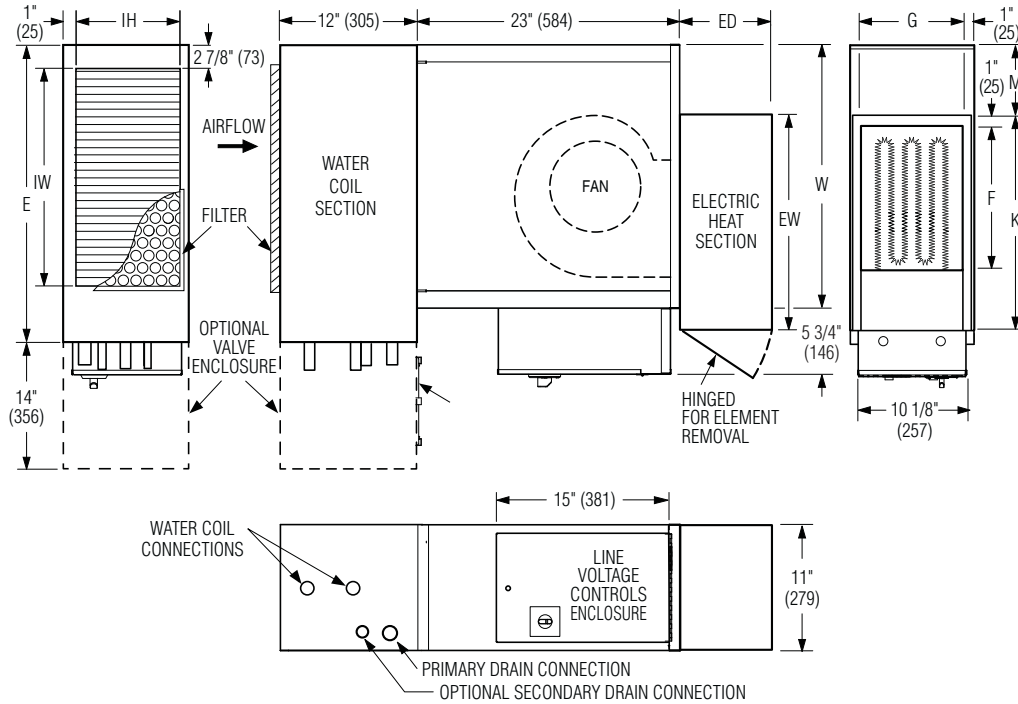

### Dimensional Data

Unit Size	Nominal CFM (l/s)	W	E	Inlet IW x IH	Outlet Duct Size F x G	ED	EW	K	M	Filter Size W x H
5	500 (236)	23 (584)	26 (660)	19 x 8 3/4 (483 x 222)	12 1/2 x 9 (318 x 229)	8 (203)	18 3/4 (476)	18 3/4 (476)	6 1/8 (156)	20 x 10 (508 x 254)
8	800 (378)	37 (940)	40 (1016)	33 x 8 3/4 (838 x 222)	12 1/2 x 9 (318 x 229)	8 - 14 (203 - 356)	18 3/4 (476)	18 3/4 (476)	12 1/4 (311)	10 x 35 (254 x 889)



Intertek



## Model Series 37FH • Direct Drive Draw-through • EPIC ECM 2 Pipe with Electric Heat • Unit Size 12

**MODEL:**

**37FHZE** Chilled/Hot water and Electric Heat

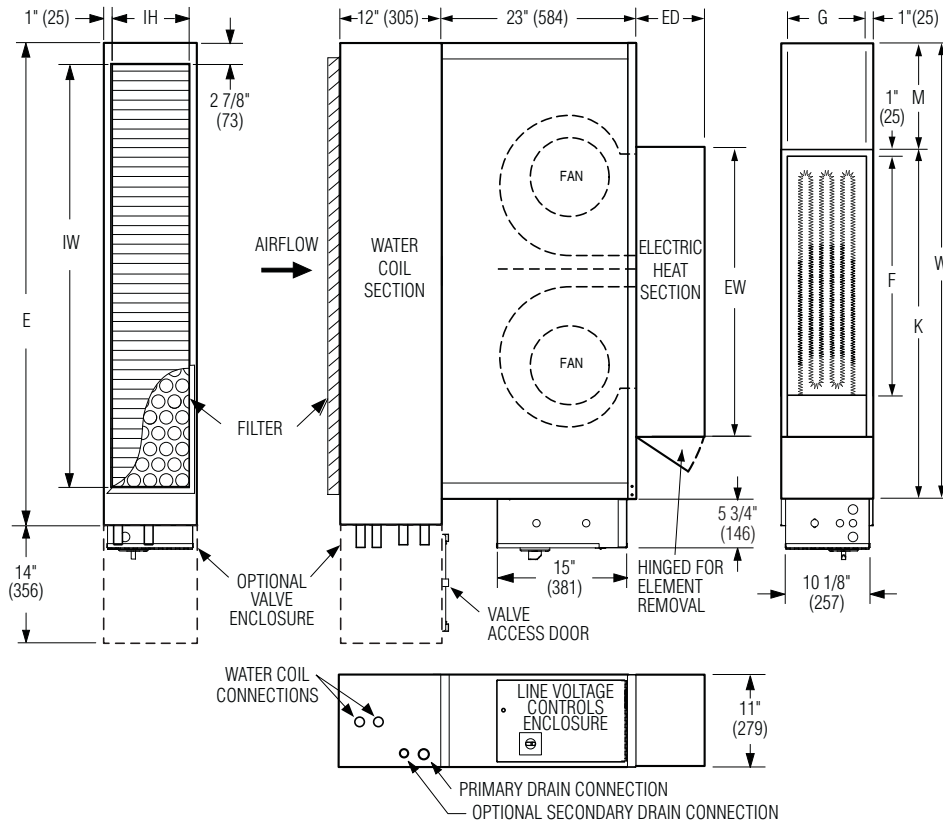

**B** HORIZONTAL HIGH CAPACITY - DUCTED

**Dimensional Data**

Unit Size	Nominal CFM (l/s)	W	E	IW x IH	Outlet Duct Size F x G	ED	EW	K	M	Filter Size W x H
12	1200 (566)	54 (1372)	57 (1448)	50 x 8 3/4 (1270 x 222)	20 x 9 (508 x 229)	8 – 14 (203 – 356)	34 3/8 (873)	41 3/8 (1051)	12 5/8 (321)	52 x 10 (1321 x 254)



## Model Series 37FH • Direct Drive Draw-through • EPIC ECM • 2 Pipe Unit Sizes 5 & 8

MODEL:

37FHW Hot Water.

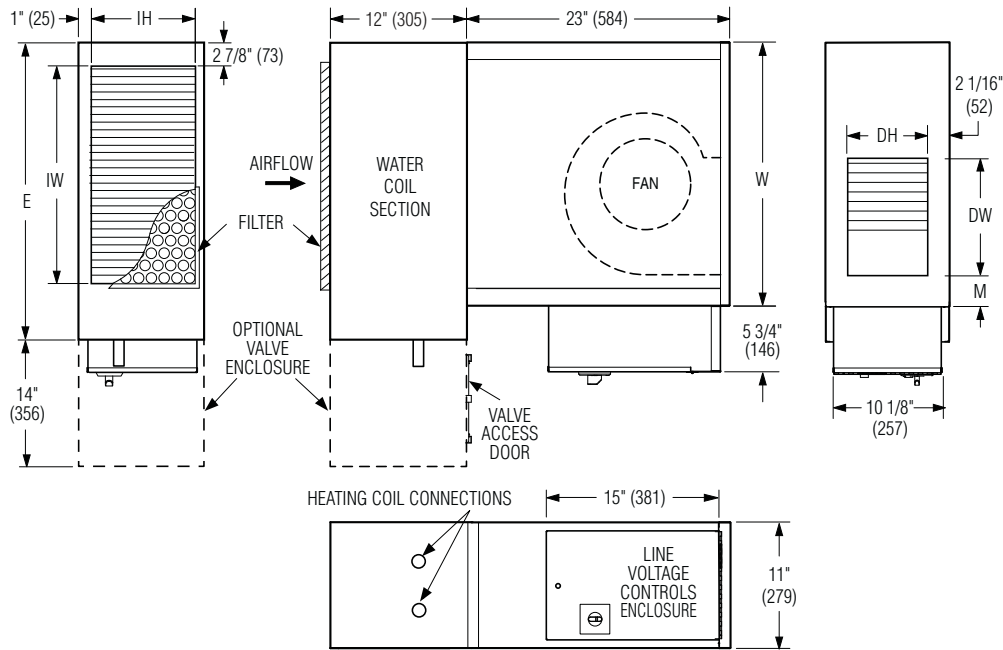

### Dimensional Data

Unit Size	Nominal CFM (l/s)	W	E	Inlet IW x IH	Outlet Discharge DW x DH	M	Filter Size W x H
5	500 (236)	23 (584)	26 (660)	19 x 8 3/4 (483 x 222)	10 1/4 x 6 3/4 (260 x 171)	2 3/4 (70)	20 x 10 (508 x 254)
8	800 (378)	37 (940)	40 (1016)	33 x 8 3/4 (838 x 222)	11 1/4 x 6 3/4 (286 x 171)	10 5/8 (270)	35 x 10 (889 x 254)



## Model Series 37FH • Direct Drive Draw-through • EPIC ECM • 2 Pipe Unit Size 12

**MODEL:**  
**37FHW** Hot Water.

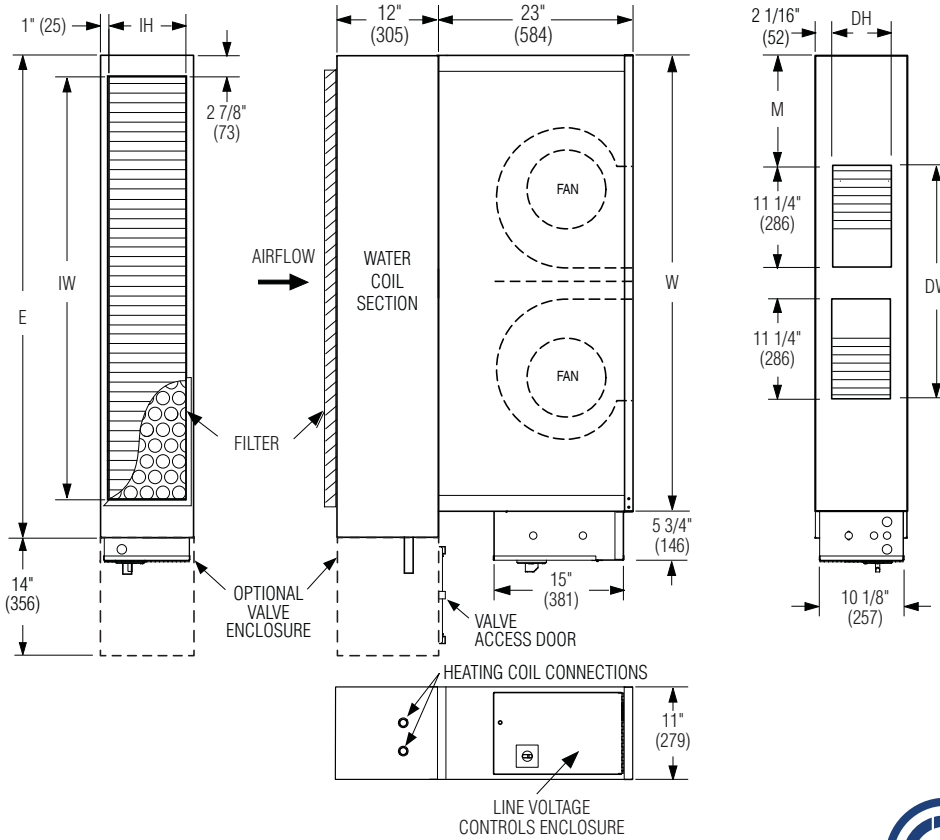

### Dimensional Data

Unit Size	Nominal CFM (l/s)	W	E	IW x IH	Outlet Discharge DW x DH	M	Filter Size W x H
12	1200 (566)	54 (1372)	57 (1448)	50 x 8 3/4 (1270 x 222)	26 3/4 x 6 3/4 (679 x 171)	13 5/8 (321)	52 x 10 (1321 x 254)



**B** HORIZONTAL HIGH CAPACITY - DUCTED

## Model Series 37FH • Direct Drive Draw Through • EPIC ECM Electric Heat Only • Unit Sizes 5, 8 & 12

### MODEL:

37FHE Electric Heat.

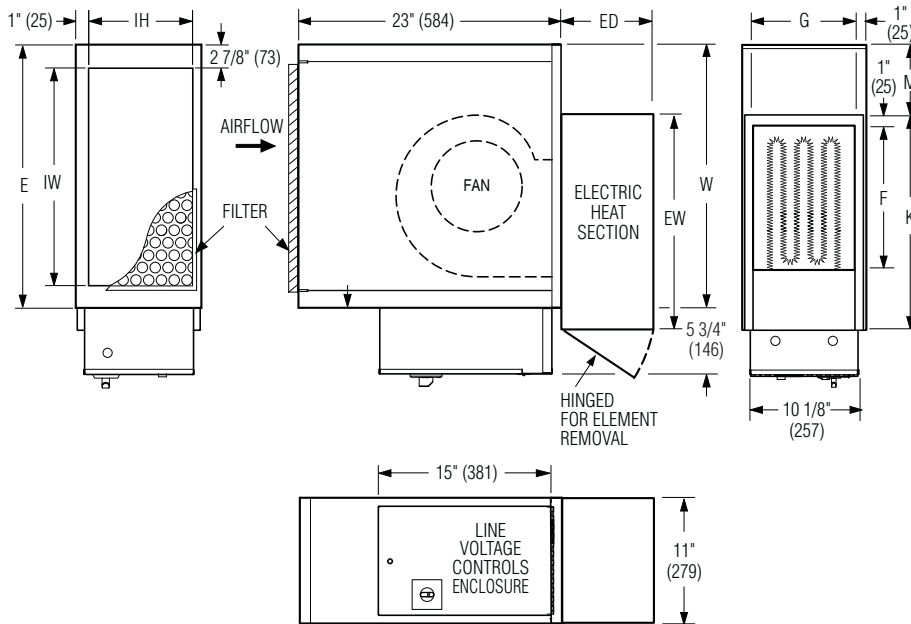

### Dimensional Data

Unit Size	Nominal CFM (l/s)	W	E	Inlet IW x IH	Outlet Duct Size F x G	ED	EW	K	M	Filter Size W x H
5	500 (236)	23 (584)	23 (584)	17 1/4 x 8 3/4 (438 x 222)	12 1/2 x 9 (318 x 229)	8 (203)	18 3/4 (476)	18 3/4 (476)	6 1/8 (156)	20 x 10 (508 x 254)
8	800 (378)	37 (950)	37 (940)	31 1/4 x 8 3/4 (794 x 222)	12 1/2 x 9 (318 x 229)	8 – 14 (203 – 356)	18 3/4 (476)	18 3/4 (476)	12 1/4 (311)	35 x 10 (889 x 254)



B

HORIZONTAL HIGH CAPACITY - DUCTED

## Model Series 37FH • Direct Drive Draw-through • EPIC ECM Electric Heat Only • Unit Sizes 5, 8 & 12

**MODEL:**  
37FHE Electric Heat.

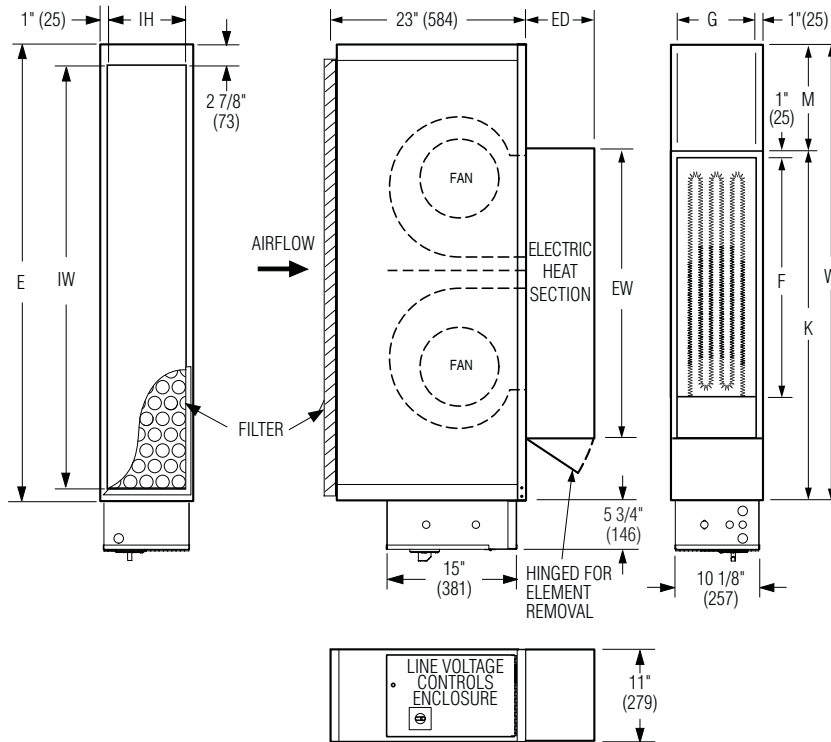

### Dimensional Data

Unit Size	Nominal CFM (l/s)	W	E	IW x IH	Outlet Duct Size F x G	ED	EW	K	M	Filter Size W x H
12	1200 (566)	54 (1372)	54 (1370)	48 1/4 x 8 3/4 (1226 x 222)	20 x 9 (508 x 229)	8 – 14 (203 – 356)	34 3/8 (873)	41 3/8 (1051)	12 5/8 (321)	52 x 10 (1321 x 254)



**B**  
HORIZONTAL HIGH CAPACITY - DUCTED



## Model Series 37FH • Direct Drive Draw-through • Supplement Outside Air Inlet (OAI) Option • Unit Sizes 5, 8 & 12

### MODELS:

- 37FHZ** Chilled/Hot Water (2-pipe).
- 37FHZW** Chilled & Hot Water (4-pipe).
- 37FHW** Hot Water Only (2-pipe).
- 37FHZE** Chilled/Hot Water (2-pipe) with Electric Heat.

### STANDARD CONSTRUCTION (OAI INLET):

1. Casing: 20 ga. (1.00), corrosion-resistant steel with stiffening beads.
2. Blade: Two layers of 20 ga. (1.00), corrosion-resistant steel laminated together with a cross-linked polyethylene peripheral gasket for tight shut-off. 90° rotation, CW to close. Damper leakage is less the 1% of the terminal rated airflow at 3" w.g. (750 pa.) and less than 2% at 6" w.g. (1500 pa.) as tested in accordance with ANSI / ASHRAE Standard 130.
3. Bearings: Self-lubricating oilite bronze.
4. Drive Shaft/Axles: 1/2" (13) diameter plated steel, double-bolted to blades. Indicator mark on the end of the shaft to show damper position.
5. Multi-point averaging Diamond Flow Sensor: Aluminum construction. Supplied with brass balancing tees. See EC-IOM-FCK for associated K-factor(s).

### OPTION:

1. Full NEMA 1 type controls enclosure for field mounted controllers/actuators.

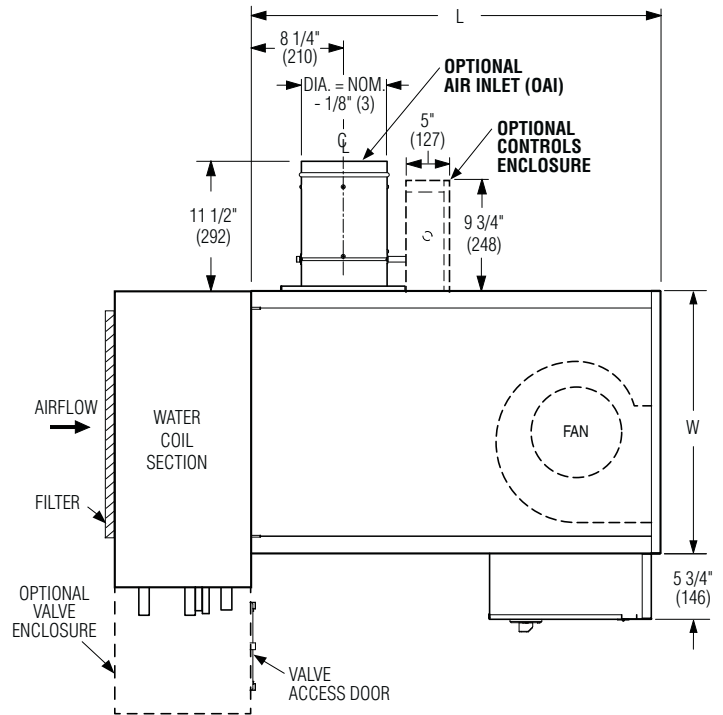

**Dimensional Data**

Unit Size	Nominal CFM (l/s)	Available Outside Air Inlet (OAI) DIA.	W	L
5	500 (236)	4, 5, 6, 8 (102, 127, 152, 203)	23 (584)	36 (914)
8	800 (378)		37 (940)	36 (914)
12	1200 (566)		54 (1372)	36 (914)

## Model Series 37FH • Filter Rack Option • Options and Accessories

### DESCRIPTION

- The FFR Ducted Return Filter Rack Connection is an optional accessory for the Horizontal Fan Coil Units Model Series 35FH and 37FH.
- The accessory is required for ducted inlet applications where a filter is also required and ease of accessibility is required.
- The Ducted Filter Connection features a filter rack, which accommodates a 1" (25) standard or 2" (51) optional filter.
- Factory mounted on the induced air inlet of the draw-through water coil section.
- A piano-hinged door flap with latch on the side and bottom of the unit accessory allows for easy removal and replacement of the filter.
- The accessory is provided with a nominally sized duct connection collar.
- Side access to filter is same as coil hand.

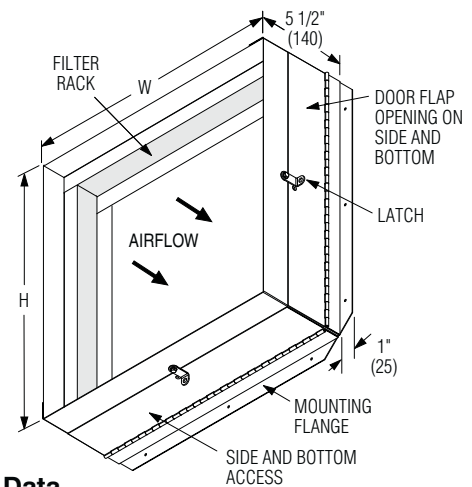

**Dimensional Data**

Unit Size	Inlet Size H x W	Filter Size W x H (Nominal)
5	20 1/4 x 10 1/2 (514 x 267)	20 x 10 (508 x 254)
8	35 1/4 x 10 1/2 (895 x 267)	35 x 10 (889 x 254)
12	52 1/4 x 10 1/2 (1327 x 267)	52 x 10 (1321 x 254)

B

HORIZONTAL HIGH CAPACITY - DUCTED

## Model Series 37FH • EPIC ECM Motor • Fan Performance Curves

### Airflow vs. External Static Pressure

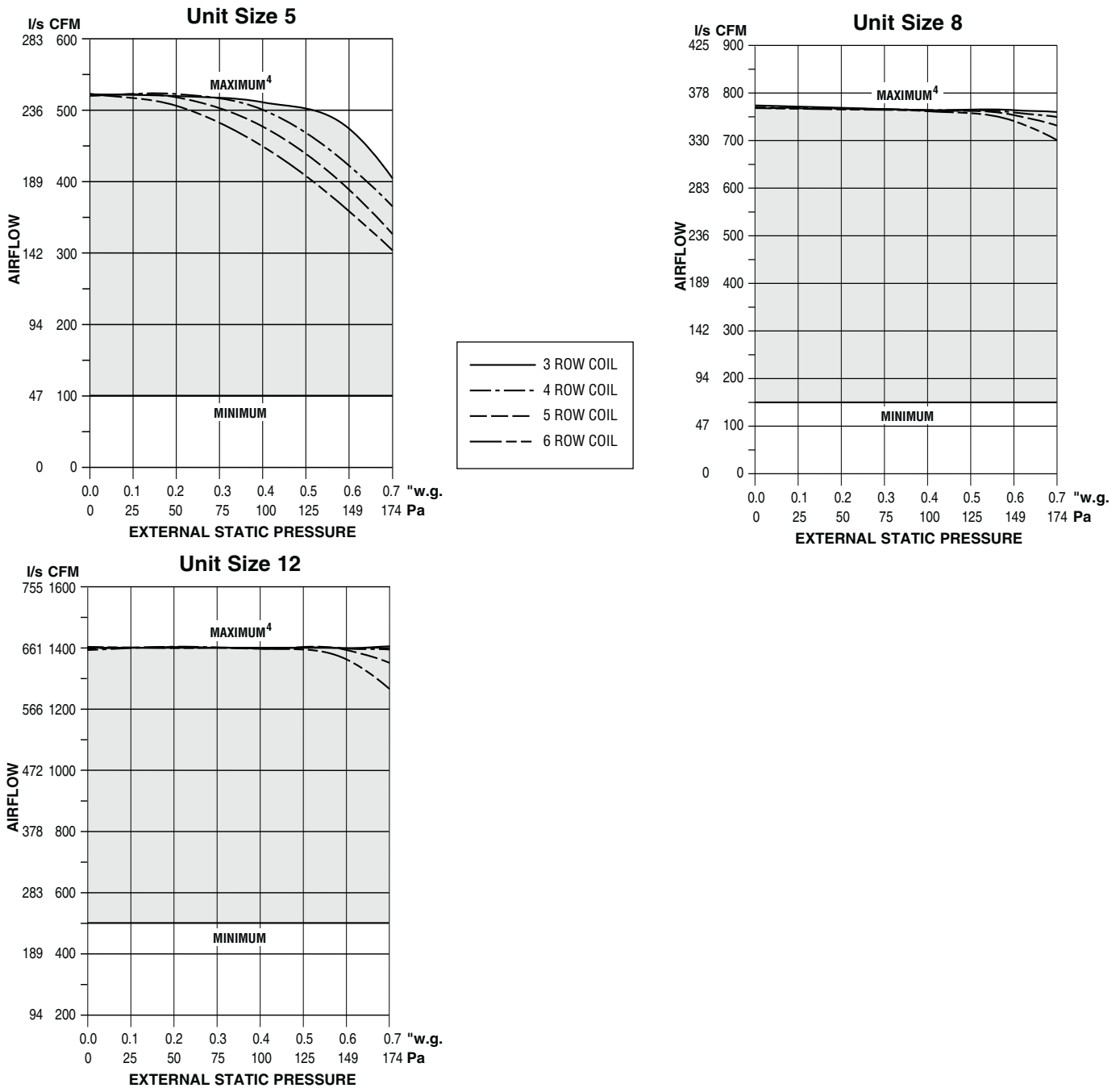

**B** HORIZONTAL HIGH CAPACITY - DUCTED

#### EPIC ECM Notes:

1. The EPIC ECM is a pressure independent constant volume device at set point and airflow does not vary with changing static pressure condition. The motor compensates for any changes in static pressure such as filter loading. Variations in airflow are generated by the controls which reset the fan airflow based on room demand. (See control sequence).
2. Airflow can be set to operate at any point within shaded area under the selected water coil curve using the EPIC volume controller provided.
3. Fan curves shown are applicable to 120/208/240 and 277 volt, single phase EPIC ECM (motors).
4. The maximum curve represents unit performance with a 3-row coil. For one (1) or two (2) row hot water coils (37FHW heating unit) performance will be slightly better. Model 37FHE (electric heat only) performance data will be comparable to a one (1) row unit. See SelectWorks for performance data Characteristics.
5. Filter pressure drops table shown on page B52.

## Model Series 37FH • Performance Data

### Electrical Motor Characteristics

Unit Size	Voltage	No. of Fans/Motors	EPIC ECM	
			FLA	Full Load Watts
5	120	1/1	1.9	146
	208	1/1	1.3	
	230	1/1	1.2	
	277	1/1	1.2	
8	120	1/1	3.8	320
	208	1/1	2.6	
	230	1/1	2.5	
	277	1/1	2.6	
12	120	2/2	6.2	520
	208	2/2	4.1	
	230	2/2	3.9	
	277	2/2	3.8	

The FLA and watts are shown at the maximum setting for selected motor type and unit size. The EPIC ECM will provide a much lower amp and watt consumption under application conditions. Refer to SelectWorks selection software for application specific data.

### Filter Pressure Drop Adjustments (in w.g.)

Unit Size	Airflow		Velocity		Filter Type			Filter Size W x H
	CFM	l/s	fpm	m/s	1" (25) Throwaway	2" (51) MERV 8	2" (51) MERV 13	
5	500	236	360	1.829	0.095	0.192	0.296	20 x 10 (508 x 254)
	400	189	288	1.463	0.066	0.134	0.224	
	300	142	216	1.097	0.037	0.077	0.153	
8	750	354	309	1.570	0.074	0.151	0.245	35 x 10 (889 x 254)
	600	283	247	1.255	0.049	0.102	0.184	
	450	212	185	0.940	0.025	0.052	0.122	
12	1400	661	388	1.971	0.106	0.214	0.325	52 x 10 (1321 x 254)
	1120	529	310	1.575	0.075	0.152	0.247	
	840	396	233	1.184	0.044	0.090	0.169	

#### NOTES:

1. Pressure drop based on clean filters. Using any type of filter will lower unit airflow.
2. To determine fan airflow with the addition of a filter, add the filter pressure drop to the external static pressure on the fan curve or use Selectworks.



Front: 1" (25) Throwaway  
Middle: 2" (51) MERV 13  
Back: 2" (51) MERV 8

## Model Series 37FH • Performance Data Sound Power Levels and NC Level Application Guide • EPIC ECM Motor

Unit Size	Airflow CFM    l/s		Discharge Sound Power Levels							Radiated Sound Power Levels								
			Octave Bands							NC	Octave Bands							NC
			2	3	4	5	6	7	2		3	4	5	6	7			
5	500	236	72	67	64	63	60	56	26	68	60	56	53	44	35	33		
	400	189	69	63	61	59	56	51	23	65	57	53	50	40	30	29		
	300	142	65	59	58	55	52	45	21	59	54	50	45	35	24	24		
	200	94	60	53	52	48	43	34	15	58	52	48	42	32	19	22		
	100	47	56	43	27	23	10	10	15	10	45	40	30	10	10	15		
8	783	369	75	71	67	66	64	61	30	71	63	61	59	49	39	36		
	625	295	70	66	63	62	59	56	25	66	59	58	55	44	34	33		
	450	212	64	61	58	56	53	48	19	62	55	54	49	39	27	29		
	275	130	60	56	54	51	48	39	15	57	52	51	45	35	21	25		
	100	47	56	48	39	34	23	10	15	50	47	44	37	24	10	18		
12	1483	700	77	74	71	71	68	66	34	75	66	65	64	55	48	41		
	1300	613	75	72	68	68	65	63	31	73	63	63	62	53	45	39		
	1100	519	72	68	66	65	61	58	26	70	61	61	59	50	42	36		
	900	425	68	64	63	61	58	54	21	66	58	58	56	47	38	33		
	700	330	65	60	60	58	54	49	16	64	56	56	53	43	34	31		
	500	236	61	58	57	55	51	44	15	60	54	54	50	39	29	29		
	300	142	55	52	51	48	42	32	15	58	53	53	47	36	25	28		

### Performance Notes:

- Fan discharge (external) static pressure is 0.25" w.g. (63 Pa) in all cases. It is the difference ( $\Delta P_s$ ) in static pressure from fan coil unit discharge to the room.
- Discharge sound power is the noise emitted from the unit discharge into the downstream duct.
- Radiated sound power is the breakout noise transmitted through the unit casing walls.
- Sound power levels in decibels, dB re  $10^{-12}$  watts.
- All sound data listed by octave bands is raw data without any corrections for room absorption or duct attenuation.
- Data derived from independent tests in accordance with AHRI Standard 880.
- NC levels are calculated from the published raw data and based on procedures outlined in Appendix E, AHRI Standard 885.
- Fan discharge sound attenuation deductions are based on environmental effect, duct lining, branch power division, insulated flexible duct, end reflection and space effect and are as follows:
 

Discharge attenuation	Octave Band						
	2	3	4	5	6	7	
< 300 cfm	24	28	39	53	58	40	
300 – 700 cfm	27	29	40	51	53	39	
> 700 cfm	29	30	41	51	52	39	
- Radiated sound attenuation deductions are based on a mineral tile ceiling and environmental effect and are as follows:
 

Radiated attenuation	Octave Band						
	2	3	4	5	6	7	
Total dB reduction	18	19	20	26	31	36	
- Dash (–) in space denotes an NC level of less than 20.

**B**

**HORIZONTAL HIGH CAPACITY - DUCTED**

## Model Series 37FH • AHRI Standard Ratings

Unit Size	Airflow	Coil Row	Cooling Capacity		Water		EPIC ECM, Power Input (Watts)
	CFM (l/s)		QT	QS	Flow Rate (GPM)	WPD ft.-w.g.	
	(Dry Flow)		(BTUH)	(BTUH)			
5	600 (236)	3	11900	9300	2.5	2.4	120
		4	15300	11000	3.1	5.2	125
		5	16500	11700	3.4	2.5	130
		6	18700	12600	3.8	3.7	135
8	750 (354)	3	19700	14800	4.1	3.1	200
		4	23400	16700	4.8	2.6	210
		5	27600	18600	5.7	4.3	230
		6	29700	19600	6.1	3.2	240
12	1400 (661)	3	34700	26300	7.2	5.7	380
		4	44200	31200	9.1	11.7	390
		5	51700	34800	10.6	19.5	400
		6	55900	36800	11.4	14.7	410



**Note:** Based on 80°F DB and 67°F WB EAT, 45°F EWT 10° temperature rise, maximum fan speed. Motor type is EPIC ECM and motor voltage is 115/1/60. Airflow under dry coil conditions. All models tested at 0.05" external static pressure.

**B**

**HORIZONTAL HIGH CAPACITY - DUCTED**

## Model Series 37FH • Chilled Water Coil Performance Data • Unit Size 5

Data Based on 80°F DB 67°F WB Entering Air & 45°F Entering Water

3 Row (Total MBH)

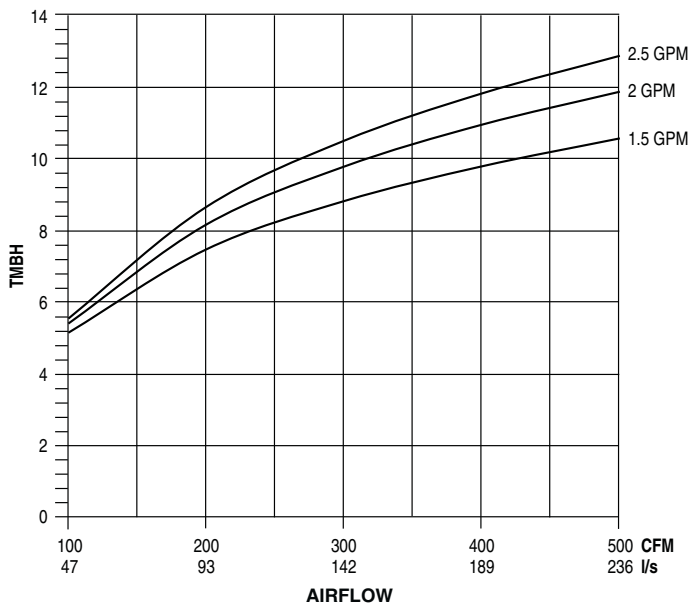

4 Row (Total MBH)

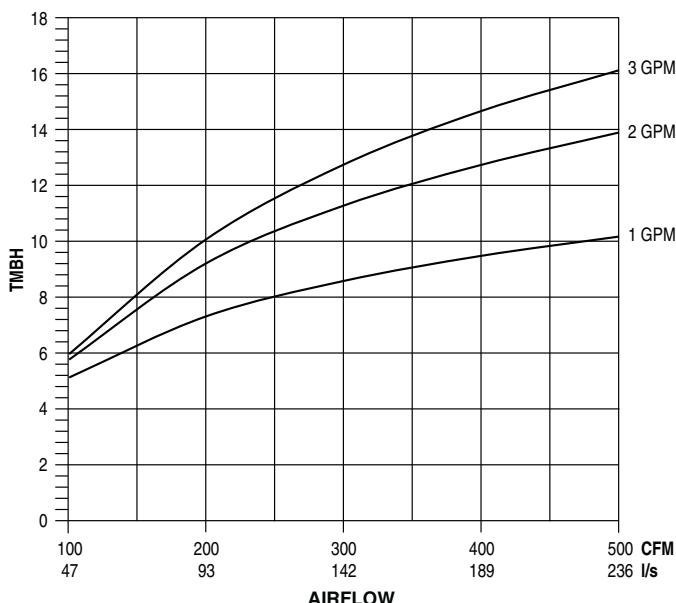

3 Row (Sensible MBH)

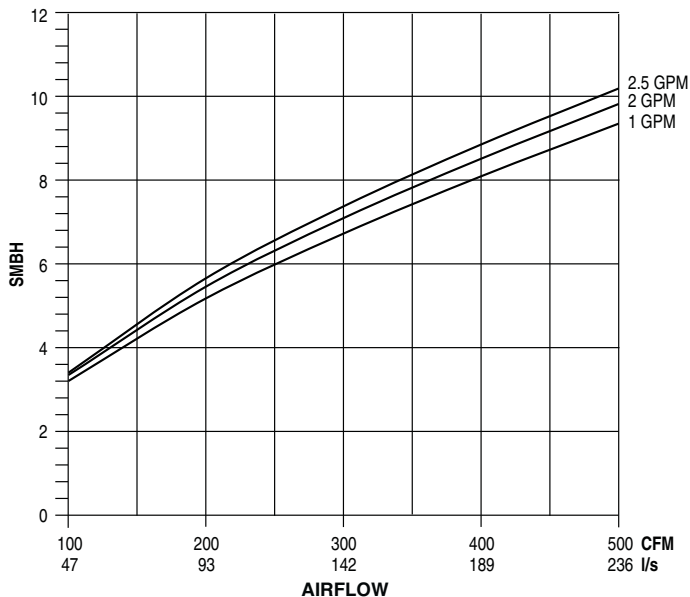

4 Row (Sensible MBH)

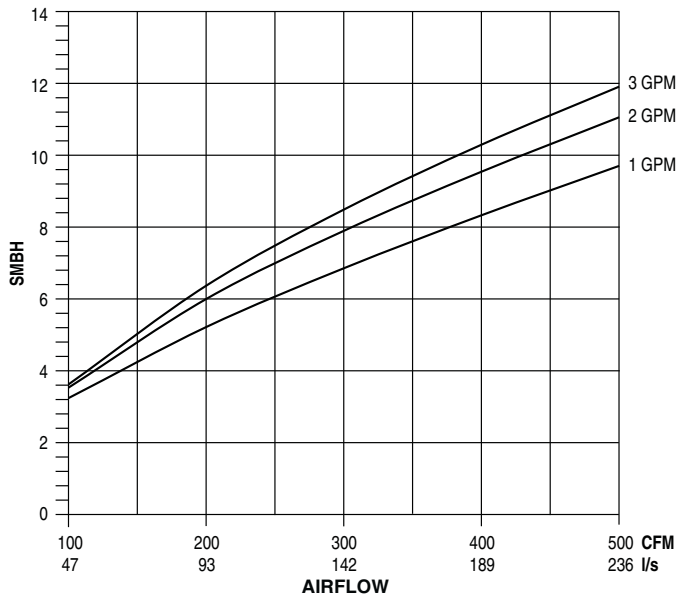

### Altitude Correction Factors

Altitude (ft.)	0	1000	2000	3000	4000	5000	6000	7000
Air Density (lb./cu.ft)	0.075	0.072	0.070	0.067	0.065	0.063	0.060	0.058
Total Capacity	1000	0.988	0.986	0.983	0.981	0.979	0.977	0.975
Sensible Capacity	1000	0.960	0.930	0.900	0.860	0.830	0.800	0.770
Static Pressure	1000	0.960	0.930	0.900	0.860	0.830	0.800	0.770

### NOTES:

Capacity and static pressure will be affected for applications above sea level. To apply correction factors, multiply the coil capacity or fan curve data by the tabulated correction factor.

Connections: 3 and 4 Row 7/8" (22.2) O.D. male solder.

## Model Series 37FH • Chilled Water Coil Performance Data • Unit Size 5

Data Based on 80°F DB 67°F WB Entering Air & 45°F Entering Water

**B** HORIZONTAL HIGH CAPACITY - DUCTED

5 Row (Total MBH)

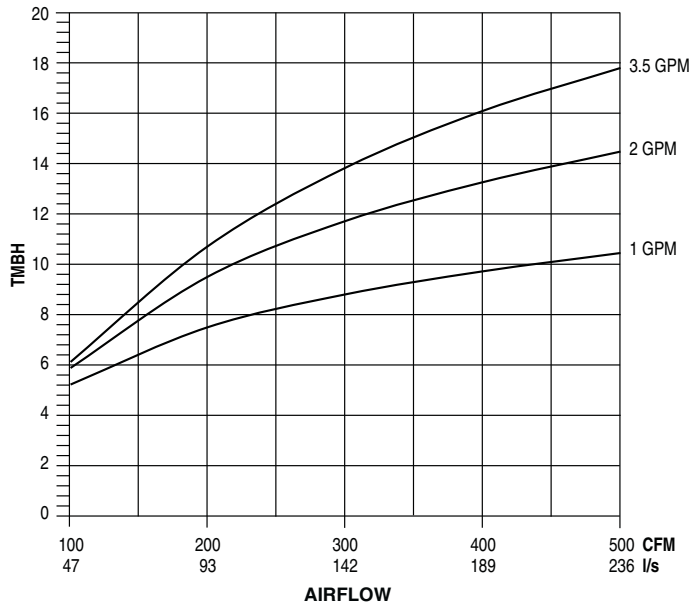

6 Row (Total MBH)

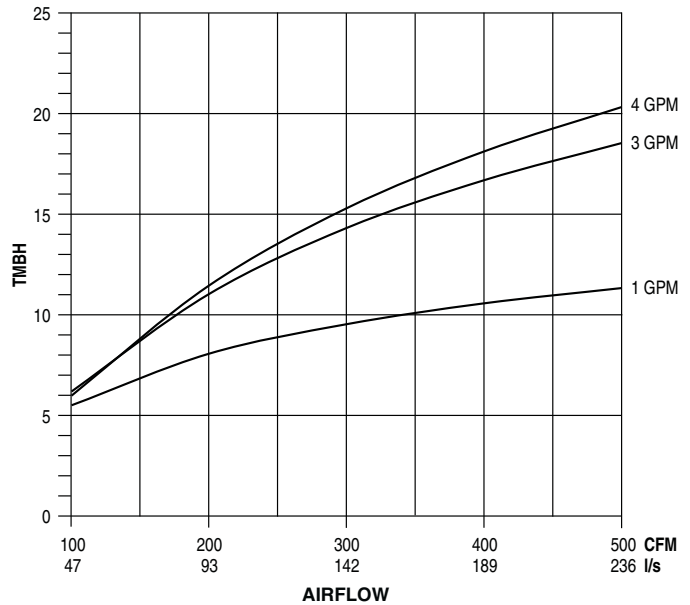

5 Row (Sensible MBH)

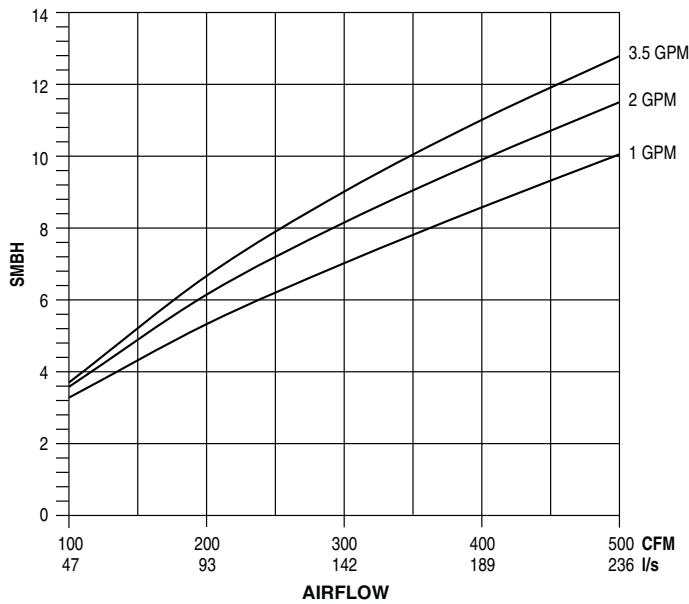

6 Row (Sensible MBH)

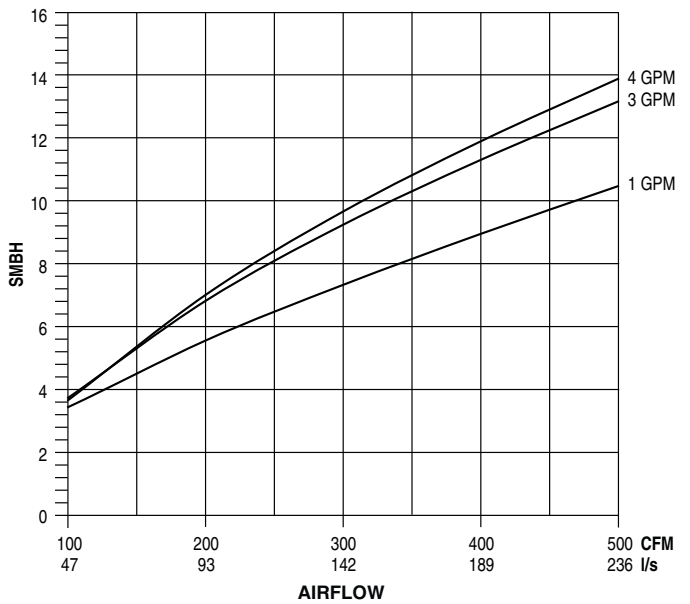

### Altitude Correction Factors

Altitude (ft.)	0	1000	2000	3000	4000	5000	6000	7000
Air Density (lb./cu. ft)	0.075	0.072	0.070	0.067	0.065	0.063	0.060	0.058
Total Capacity	1000	0.988	0.986	0.983	0.981	0.979	0.977	0.975
Sensible Capacity	1000	0.960	0.930	0.900	0.860	0.830	0.800	0.770
Static Pressure	1000	0.960	0.930	0.900	0.860	0.830	0.800	0.770

### NOTES:

- Capacity and static pressure will be affected for applications above sea level. To apply correction factors, multiply the coil capacity or fan curve data by the tabulated correction factor.
- Connections: 3 and 4 Row 7/8" (22.2) O.D. male solder.



## Model Series 37FH • Chilled Water Coil Performance Data • Unit Size 8

Data Based on 80°F DB 67°F WB Entering Air & 45°F Entering Water

3 Row (Total MBH)

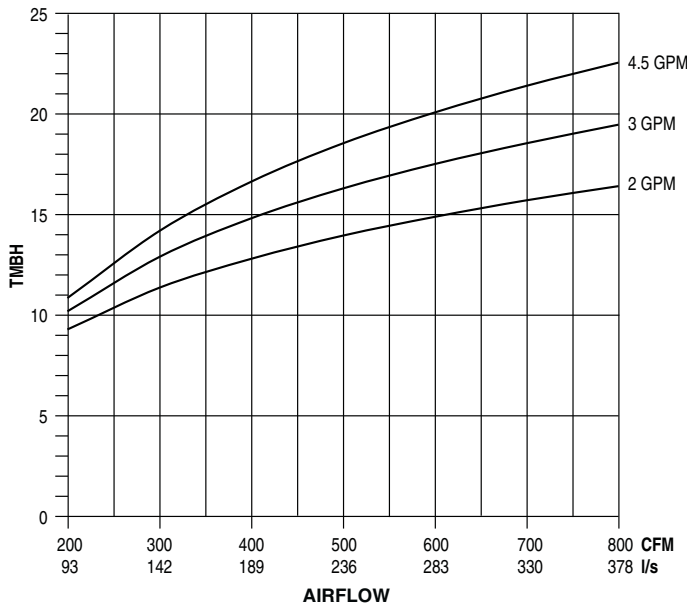

4 Row (Total MBH)

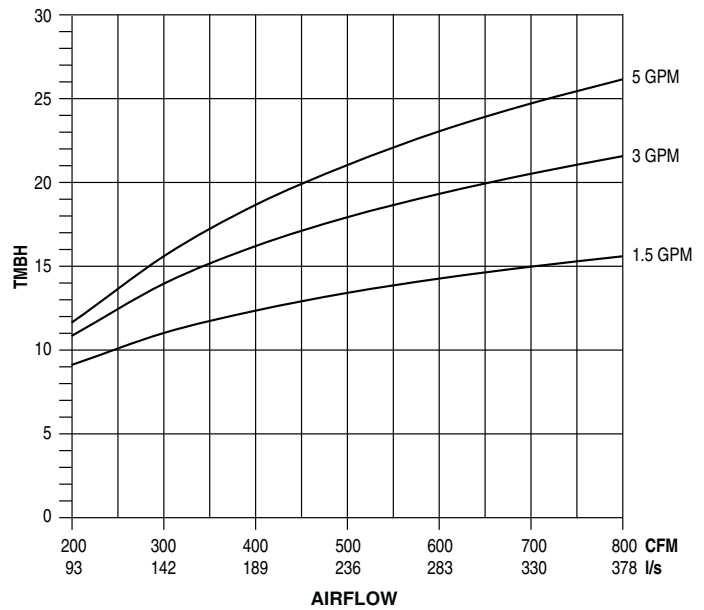

3 Row (Sensible MBH)

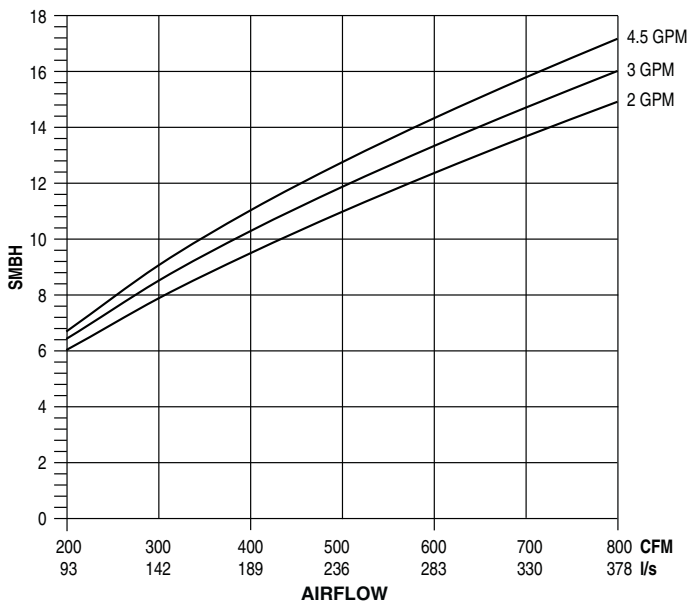

4 Row (Sensible MBH)

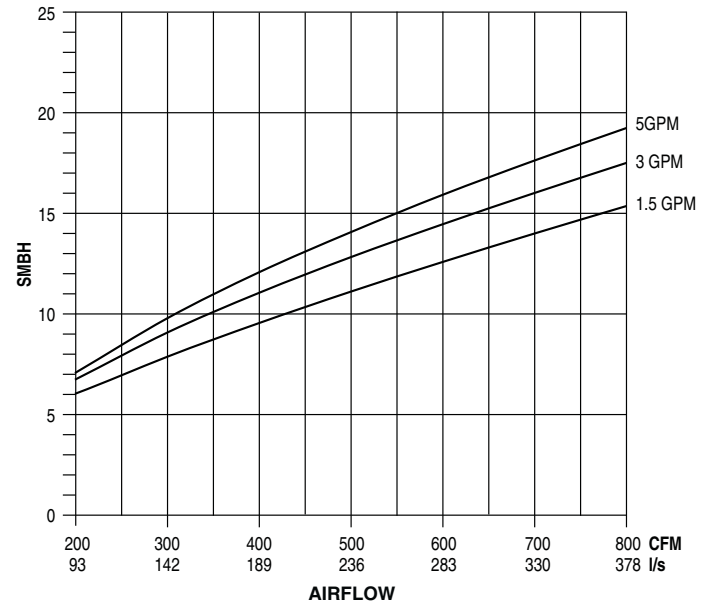

### Altitude Correction Factors

Altitude (ft.)	0	1000	2000	3000	4000	5000	6000	7000
Air Density (lb./cu. ft)	0.075	0.072	0.070	0.067	0.065	0.063	0.060	0.058
Total Capacity	1000	0.988	0.986	0.983	0.981	0.979	0.977	0.975
Sensible Capacity	1000	0.960	0.930	0.900	0.860	0.830	0.800	0.770
Static Pressure	1000	0.960	0.930	0.900	0.860	0.830	0.800	0.770

### NOTES:

- Capacity and static pressure will be affected for applications above sea level. To apply correction factors, multiply the coil capacity or fan curve data by the tabulated correction factor.
- Connections: 3 and 4 Row 7/8" (22.2) O.D. male solder.

B

HORIZONTAL HIGH CAPACITY - DUCTED

## Model Series 37FH • Chilled Water Coil Performance Data • Unit Size 8

Data Based on 80°F DB 67°F WB Entering Air & 45°F Entering Water

**B** HORIZONTAL HIGH CAPACITY - DUCTED

**5 Row (Total MBH)**

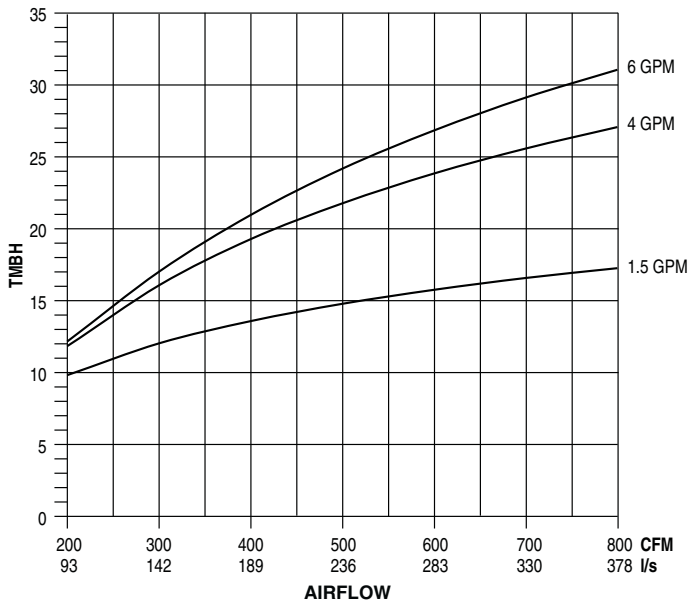

**6 Row (Total MBH)**

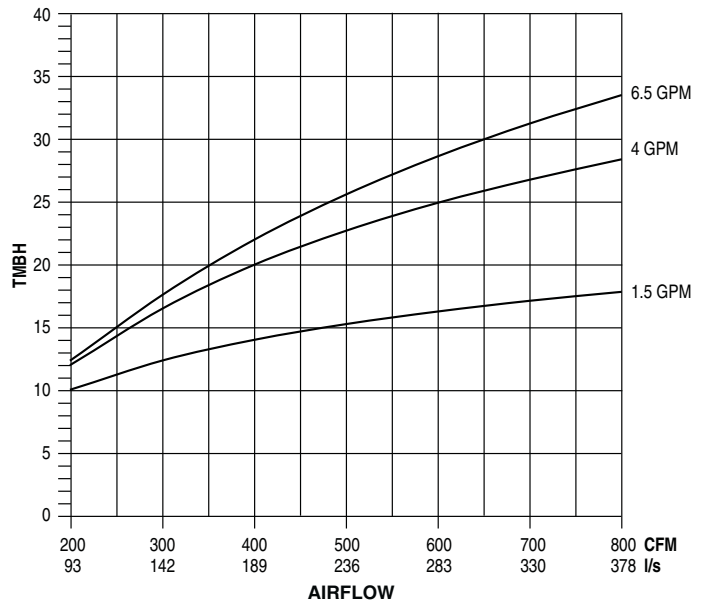

**5 Row (Sensible MBH)**

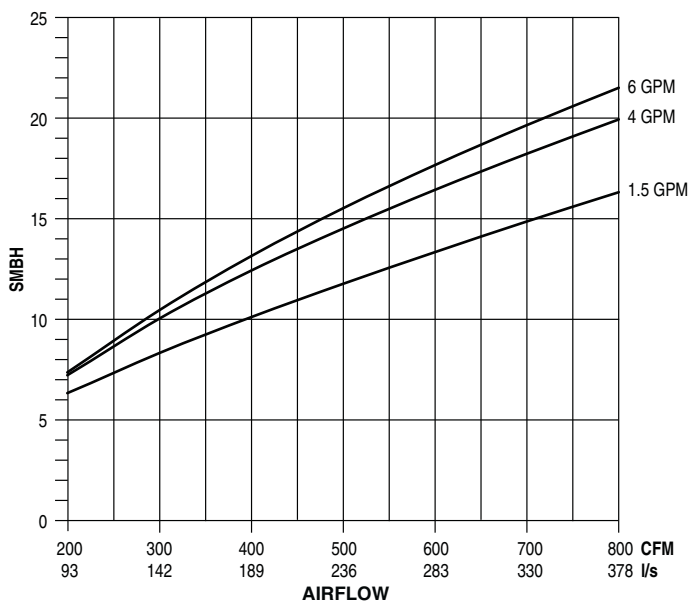

**6 Row (Sensible MBH)**

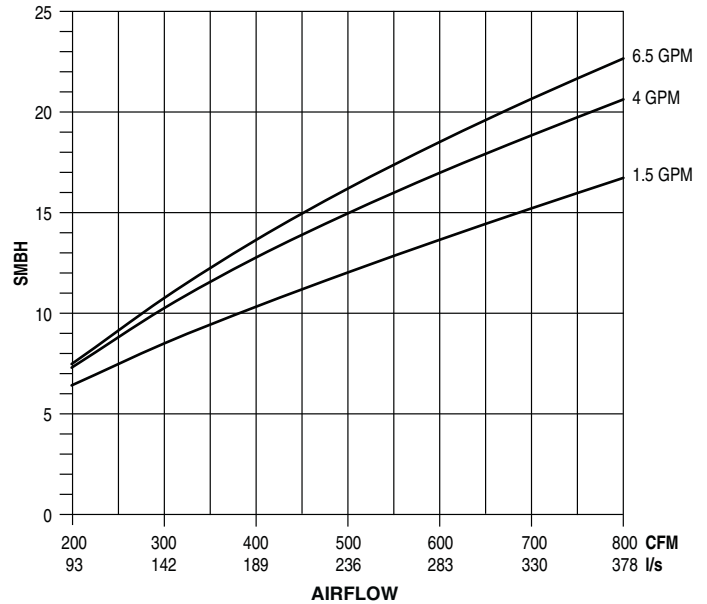

### Altitude Correction Factors

Altitude (ft.)	0	1000	2000	3000	4000	5000	6000	7000
Air Density (lb./cu. ft)	0.075	0.072	0.070	0.067	0.065	0.063	0.060	0.058
Total Capacity	1000	0.988	0.986	0.983	0.981	0.979	0.977	0.975
Sensible Capacity	1000	0.960	0.930	0.900	0.860	0.830	0.800	0.770
Static Pressure	1000	0.960	0.930	0.900	0.860	0.830	0.800	0.770

### NOTES:

- Capacity and static pressure will be affected for applications above sea level. To apply correction factors, multiply the coil capacity or fan curve data by the tabulated correction factor.
- Connections: 5 and 6 Row 7/8" (22.2) O.D. male solder.

## Model Series 37FH • Chilled Water Coil Performance Data • Unit Size 12

Data Based on 80°F DB 67°F WB Entering Air & 45°F Entering Water

**3 Row (Total MBH)**

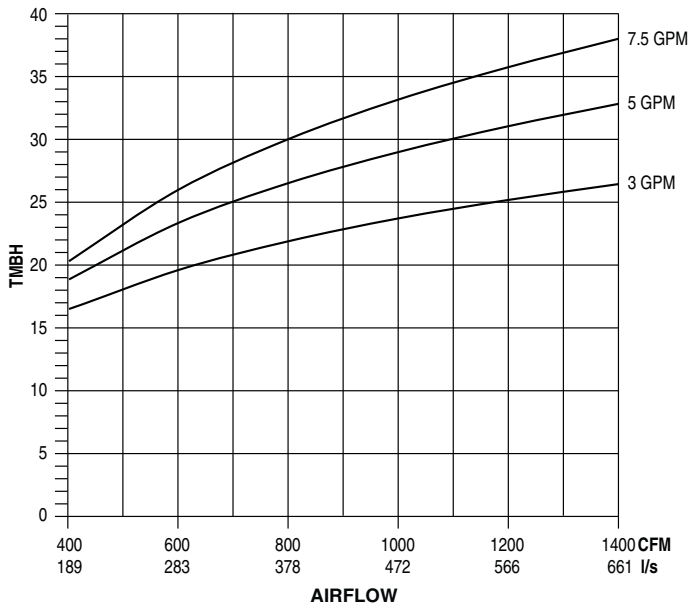

**4 Row (Total MBH)**

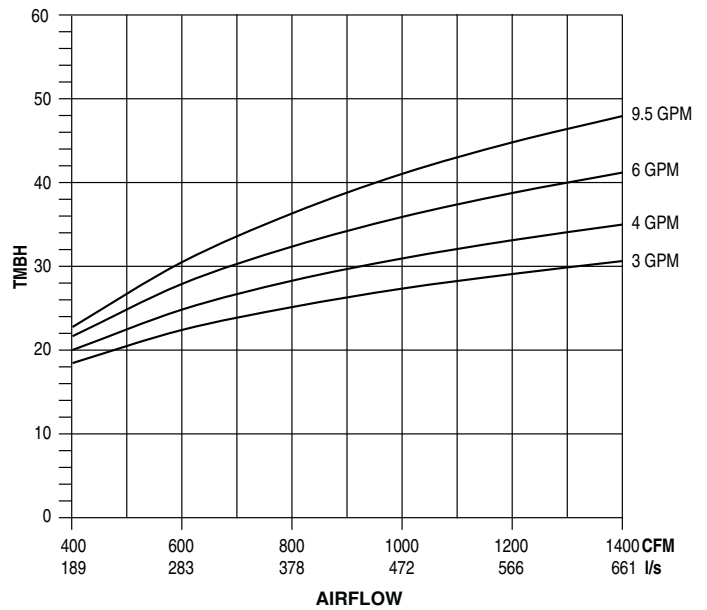

**3 Row (Sensible MBH)**

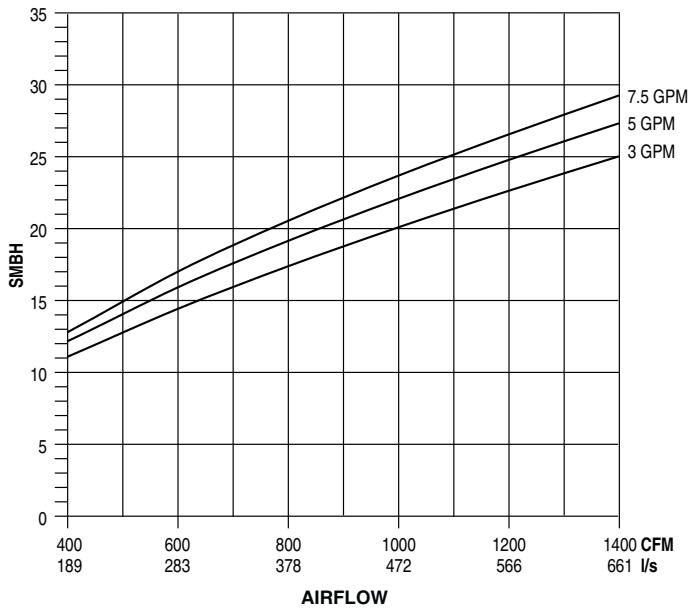

**4 Row (Sensible MBH)**

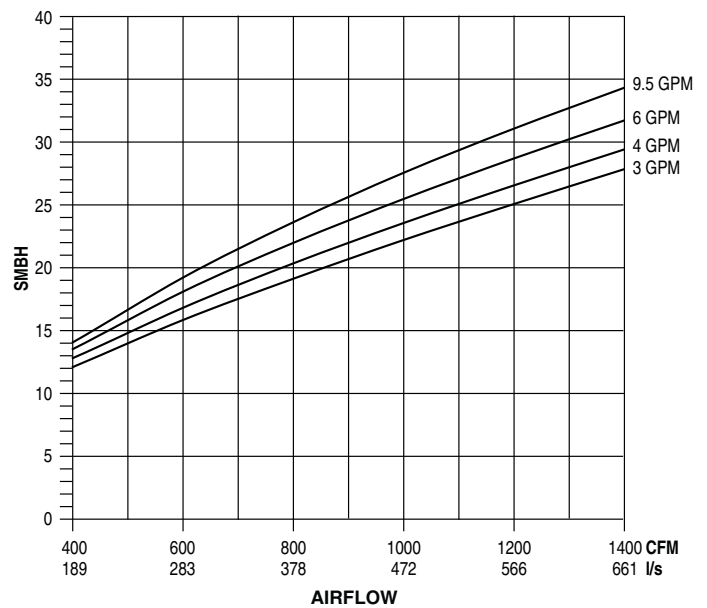

### Altitude Correction Factors

Altitude (ft.)	0	1000	2000	3000	4000	5000	6000	7000
<b>Air Density (lb./cu. ft)</b>	0.075	0.072	0.070	0.067	0.065	0.063	0.060	0.058
<b>Total Capacity</b>	1000	0.988	0.986	0.983	0.981	0.979	0.977	0.975
<b>Sensible Capacity</b>	1000	0.960	0.930	0.900	0.860	0.830	0.800	0.770
<b>Static Pressure</b>	1000	0.960	0.930	0.900	0.860	0.830	0.800	0.770

### NOTES:

- Capacity and static pressure will be affected for applications above sea level. To apply correction factors, multiply the coil capacity or fan curve data by the tabulated correction factor.
- Connections: 3 and 4 Row 7/8" (22.2) O.D. male solder.

**B**

**HORIZONTAL HIGH CAPACITY - DUCTED**

## Model Series 37FH • Chilled Water Coil Performance Data • Unit Size 12

Data Based on 80°F DB 67°F WB Entering Air & 45°F Entering Water

**B** HORIZONTAL HIGH CAPACITY - DUCTED

**5 Row (Total MBH)**

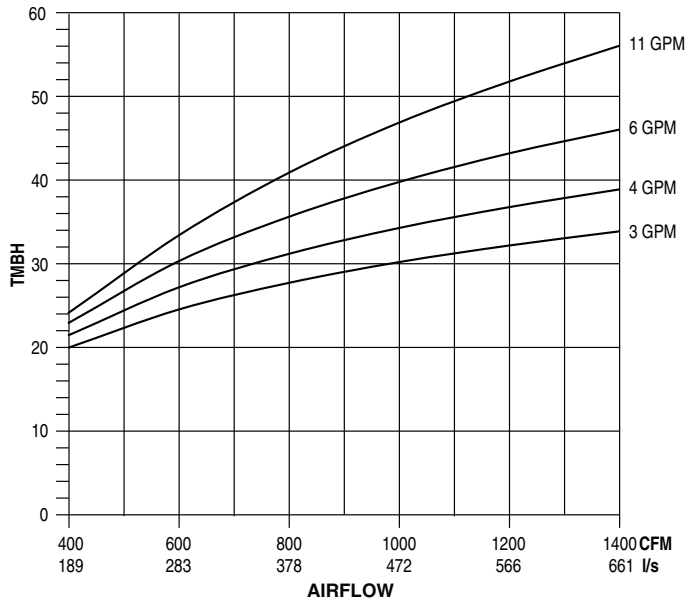

**6 Row (Total MBH)**

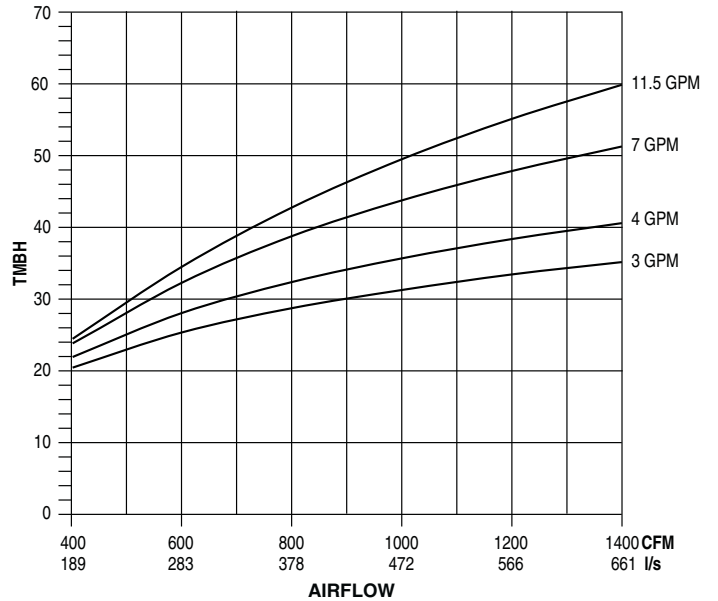

**5 Row (Sensible MBH)**

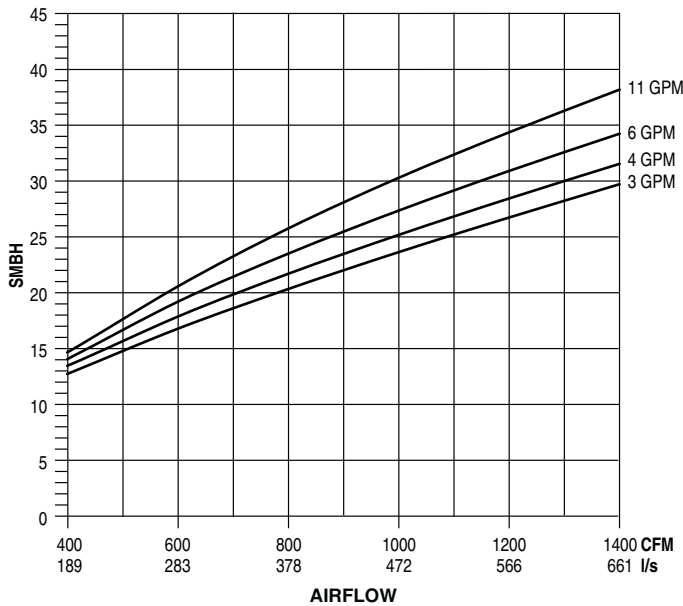

**6 Row (Sensible MBH)**

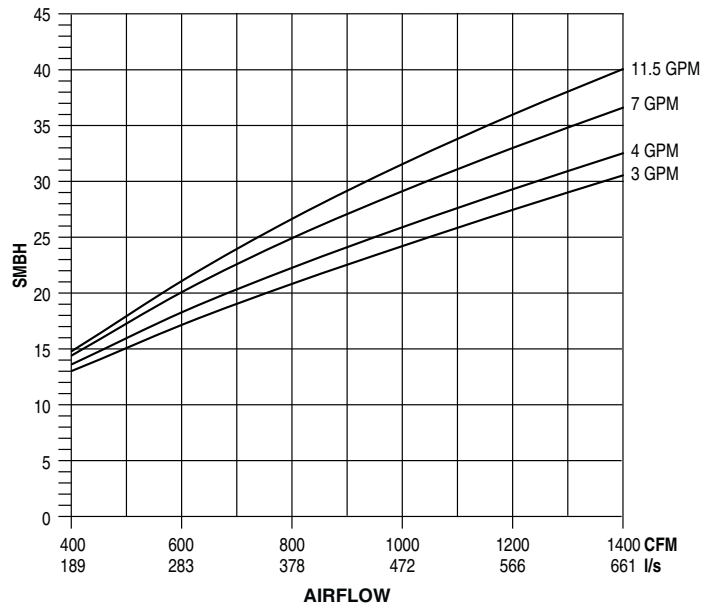

### Altitude Correction Factors

Altitude (ft.)	0	1000	2000	3000	4000	5000	6000	7000
Air Density (lb./cu. ft)	0.075	0.072	0.070	0.067	0.065	0.063	0.060	0.058
Total Capacity	1000	0.988	0.986	0.983	0.981	0.979	0.977	0.975
Sensible Capacity	1000	0.960	0.930	0.900	0.860	0.830	0.800	0.770
Static Pressure	1000	0.960	0.930	0.900	0.860	0.830	0.800	0.770

### NOTES:

- Capacity and static pressure will be affected for applications above sea level. To apply correction factors, multiply the coil capacity or fan curve data by the tabulated correction factor.
- Connections: 5 and 6 Row 7/8" (22.2) O.D. male solder.

## Model Series 37FH • Hot Water Coil Performance Data • Unit Size 5

Data Based on 70°F DB Entering Air & 180°F Entering Water

1 Row (Total MBH)

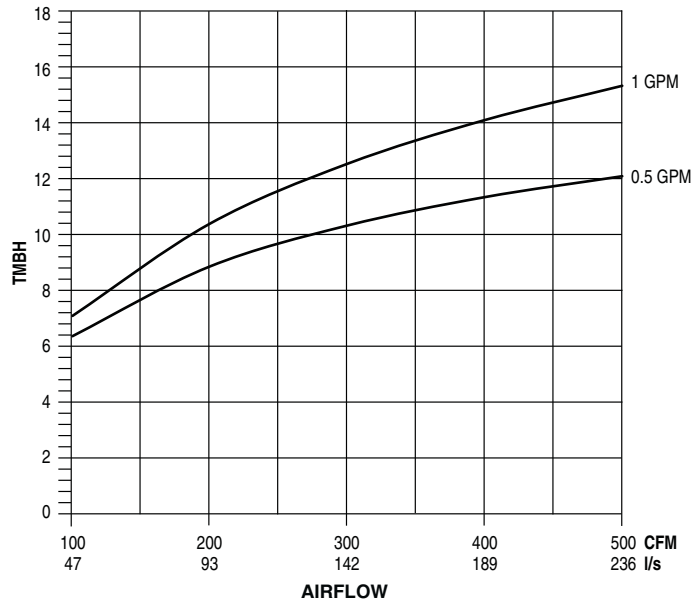

2 Row (Total MBH)

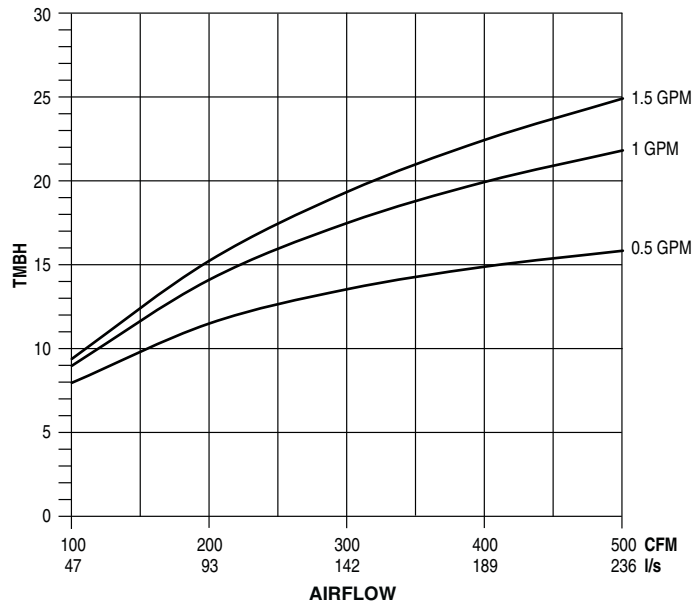

3 Row (Total MBH)

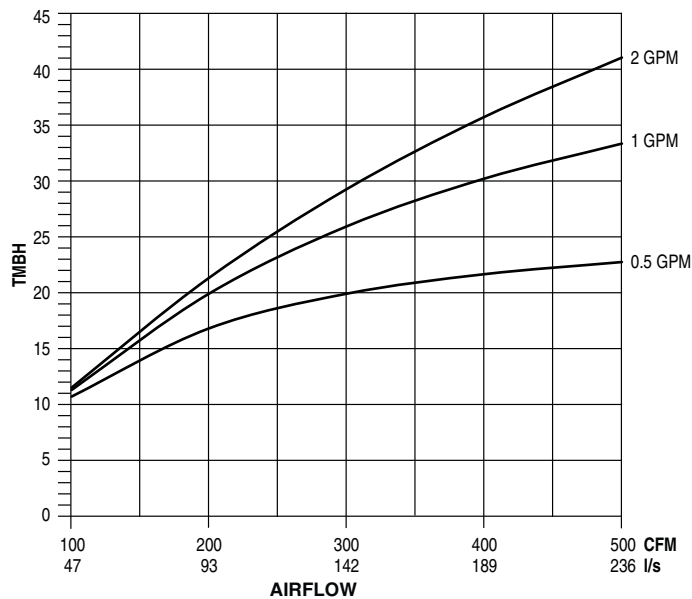

**NOTES:**

- Capacities are in MBH (kW), *thousands of Btu per hour (kiloWatts)*.
- MBH (kW) values are based on a Δt (temperature difference) of 110°F (61°C) between entering air and entering water. For other Δt's; multiply the MBH (kW) values by the factors below.

3. Air Temperature Rise.

$$ATR (°F) = 927 \times \frac{MBH}{CFM}, \quad ATR (°C) = 829 \times \frac{kW}{l/s}$$

4. Water Temp. Drop.

$$WTD (°F) = 2.04 \times \frac{MBH}{GPM}, \quad WTD (°C) = .224 \times \frac{kW}{l/s}$$

- Connections: Size 1, one and two row and size 3 one row 1/2" (12.7); Size 3 two row 7/8" (22.2) O.D. male solder.

**Altitude Correction Factors:**

Altitude ft. (m)	Sensible Heat Factor
0 (0)	1.00
2000 (610)	0.94
3000 (914)	0.90
4000 (1219)	0.87
5000 (1524)	0.84
6000 (1829)	0.81
7000 (2134)	0.78

**Correction factors at other entering conditions:**

Δt °F (°C)	50 (28)	60 (33)	70 (39)	80 (44)	90 (50)	100 (56)	110 (61)	120 (67)	130 (72)	140 (78)	150 (83)
Factor	.455 (.459)	.545 (.541)	.636 (.639)	.727 (.721)	.818 (.820)	.909 (.918)	1.00 (1.00)	1.09 (1.10)	1.18 (1.18)	1.27 (1.28)	1.36 (1.36)

**B**

HORIZONTAL HIGH CAPACITY - DUCTED

## Model Series 37FH • Hot Water Coil Performance Data • Unit Size 8

Data Based on 70°F DB Entering Air & 180°F Entering Water

**B** HORIZONTAL HIGH CAPACITY - DUCTED

**1 Row (Total MBH)**

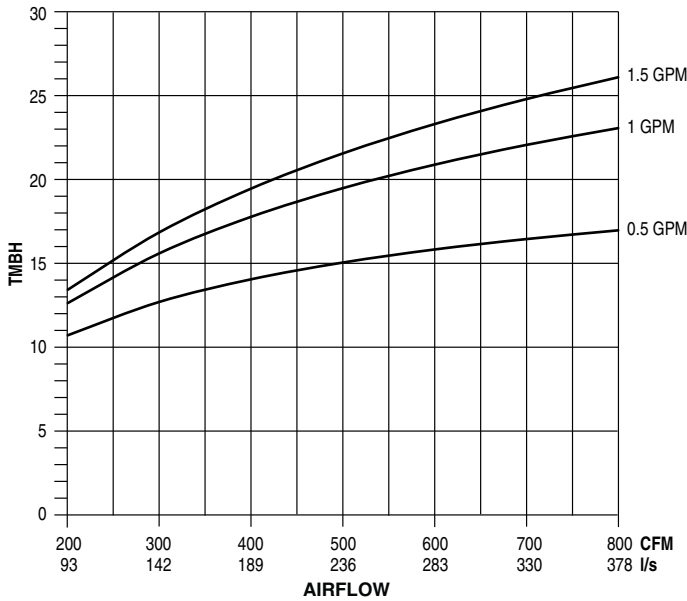

**2 Row (Total MBH)**

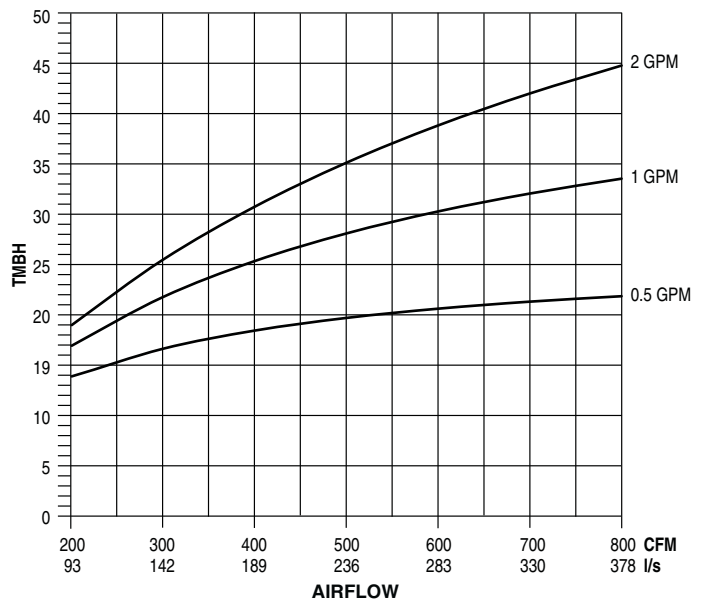

**3 Row (Total MBH)**

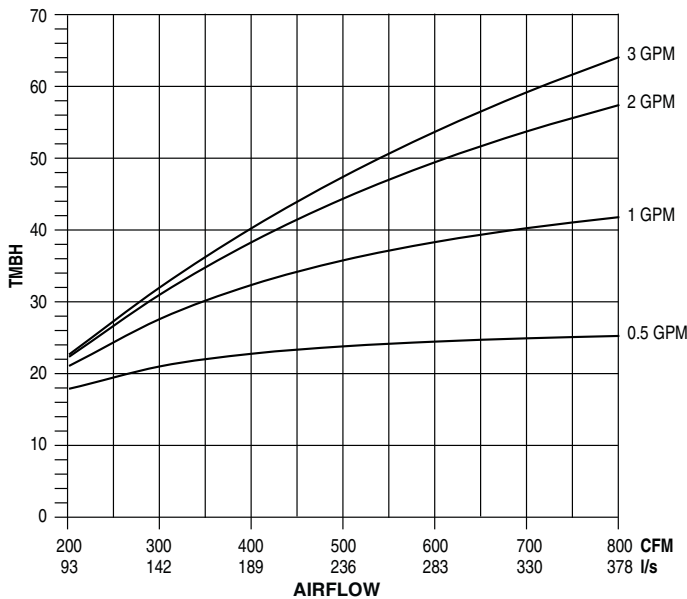

**NOTES:**

- Capacities are in MBH (kW), *thousands of Btu per hour (kiloWatts)*.
- MBH (kW) values are based on a Δt (temperature difference) of 110°F (61°C) between entering air and entering water. For other Δt's; multiply the MBH (kW) values by the factors below.

- Air Temperature Rise.  
 $ATR (°F) = 927 \times \frac{MBH}{CFM}$ ,  $ATR (°C) = 829 \times \frac{kW}{l/s}$
- Water Temp. Drop.  
 $WTD (°F) = 2.04 \times \frac{MBH}{GPM}$ ,  $WTD (°C) = .224 \times \frac{kW}{l/s}$
- Connections: Size 1, one and two row and size 3 one row 1/2" (12.7); Size 3 two row 7/8" (22.2) O.D. male solder.

**Altitude Correction Factors:**

Altitude ft. (m)	Sensible Heat Factor
0 (0)	1.00
2000 (610)	0.94
3000 (914)	0.90
4000 (1219)	0.87
5000 (1524)	0.84
6000 (1829)	0.81
7000 (2134)	0.78

**Correction factors at other entering conditions:**

Δt °F (°C)	50 (28)	60 (33)	70 (39)	80 (44)	90 (50)	100 (56)	110 (61)	120 (67)	130 (72)	140 (78)	150 (83)
Factor	.455 (.459)	.545 (.541)	.636 (.639)	.727 (.721)	.818 (.820)	.909 (.918)	1.00 (1.00)	1.09 (1.10)	1.18 (1.18)	1.27 (1.28)	1.36 (1.36)

## Model Series 37FH • Hot Water Coil Performance Data • Unit Size 12

Data Based on 70°F DB Entering Air & 180°F Entering Water

1 Row (Total MBH)

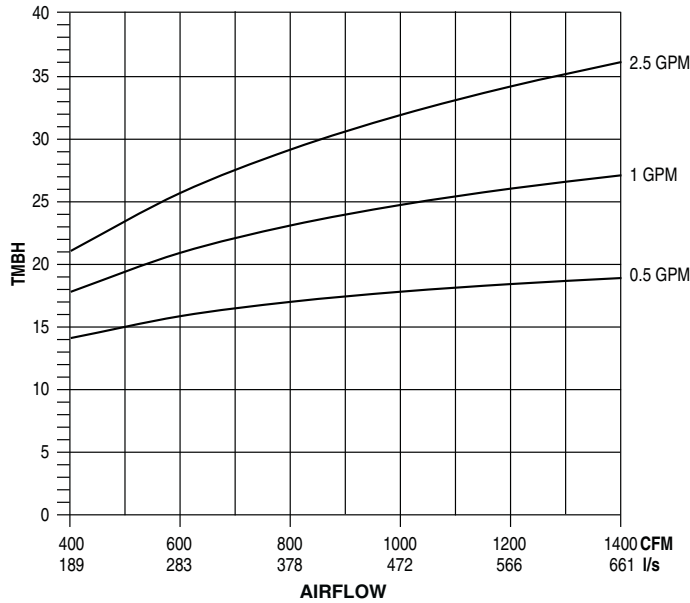

2 Row (Total MBH)

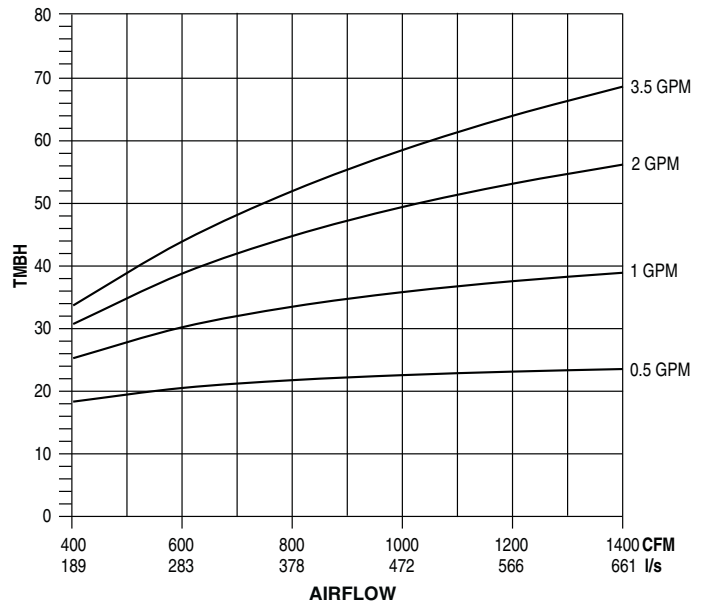

3 Row (Total MBH)

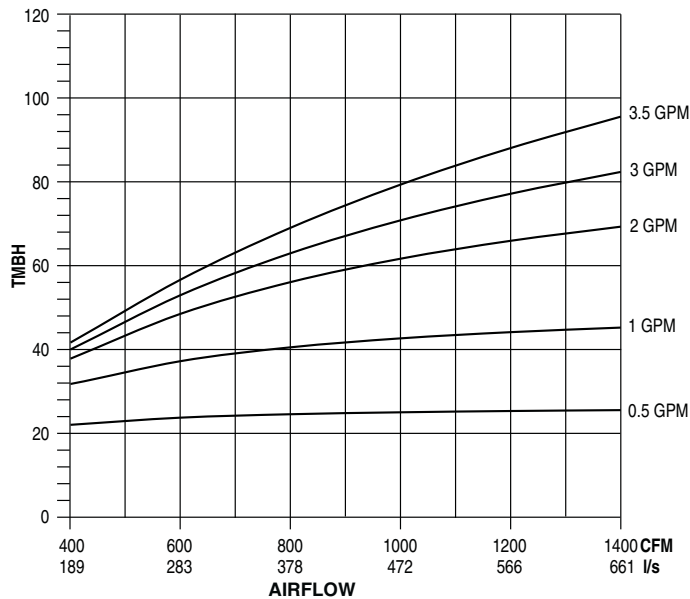

B

HORIZONTAL HIGH CAPACITY - DUCTED

**NOTES:**

- Capacities are in MBH (kW), *thousands of Btu per hour (kiloWatts)*.
- MBH (kW) values are based on a Δt (temperature difference) of 110°F (61°C) between entering air and entering water. For other Δt's; multiply the MBH (kW) values by the factors below.

- Air Temperature Rise.

$$ATR (°F) = 927 \times \frac{MBH}{CFM}; \quad ATR (°C) = 829 \times \frac{kW}{l/s}$$

- Water Temp. Drop.

$$WTD (°F) = 2.04 \times \frac{MBH}{GPM}; \quad WTD (°C) = .224 \times \frac{kW}{l/s}$$

- Connections: Size 1, one and two row and size 3 one row 1/2" (12.7); Size 3 two row 7/8" (22.2) O.D. male solder.

**Altitude Correction Factors:**

Altitude ft. (m)	Sensible Heat Factor
0 (0)	1.00
2000 (610)	0.94
3000 (914)	0.90
4000 (1219)	0.87
5000 (1524)	0.84
6000 (1829)	0.81
7000 (2134)	0.78

**Correction factors at other entering conditions:**

Δt °F (°C)	50 (28)	60 (33)	70 (39)	80 (44)	90 (50)	100 (56)	110 (61)	120 (67)	130 (72)	140 (78)	150 (83)
Factor	.455 (.459)	.545 (.541)	.636 (.639)	.727 (.721)	.818 (.820)	.909 (.918)	1.00 (1.00)	1.09 (1.10)	1.18 (1.18)	1.27 (1.28)	1.36 (1.36)



## Model Series 37FH • Coil Performance Data • Pressure Drop

### Unit Size 5

Chilled Water Pressure Drop

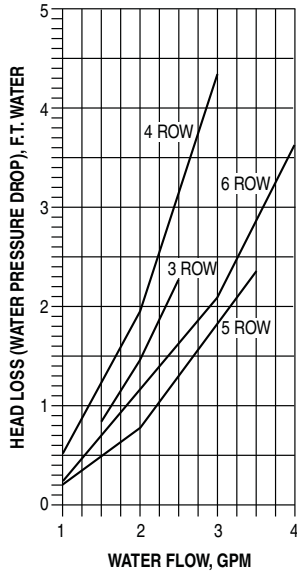

Hot Water Pressure Drop

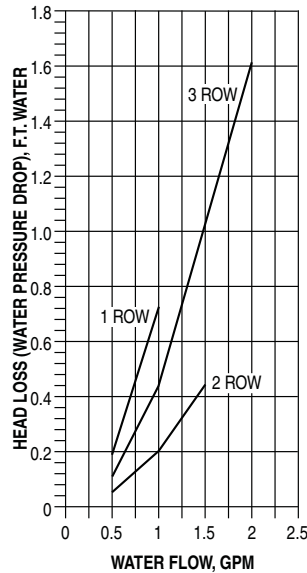

Chilled and Hot Water Air Pressure Drop

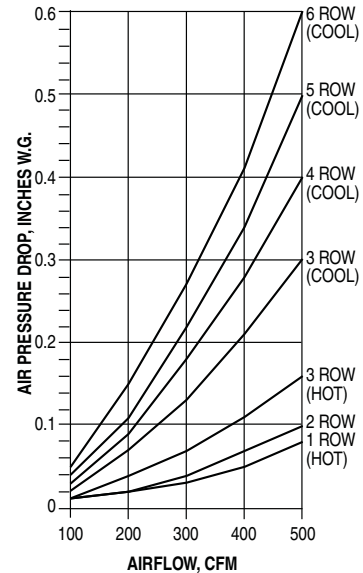

### Unit Size 8

Chilled Water Pressure Drop

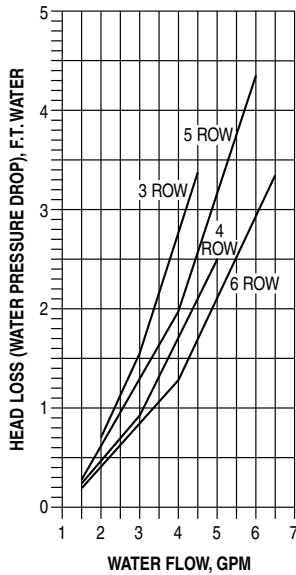

Hot Water Pressure Drop

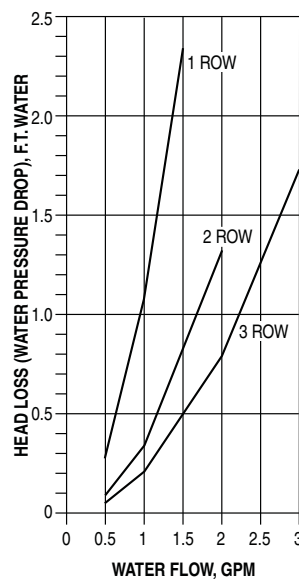

Chilled and Hot Water Air Pressure Drop

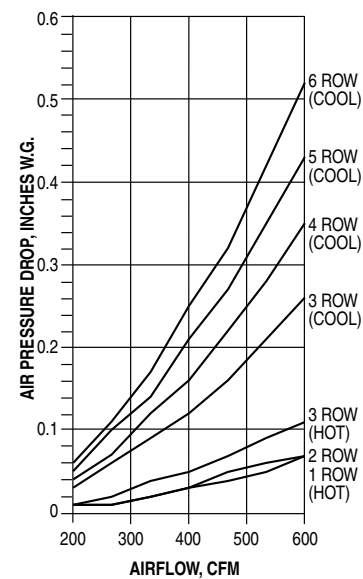

**Metric Conversion Factors:**

1. Water Flow (liters per second)  
l/s = gpm x 0.6309
2. Water Head Loss (kilopascals):  
kPa = ft. w.g. x 2.9837
3. Airflow Volume (liters per second)  
l/s = CFM x 0.472

4. Air Pressure Drop (Pascals):  
Pa = in. w.g. x 248.6
5. Heat (kilowatts):  
kW = Mbh x 0.293
6. Air Temperature Rise.  
 $ATR = 927 \times \frac{Mbh}{CFM}$

7. Water Temp. Drop.  
 $WTD = 2.04 \times \frac{Mbh}{GPM}$

B HORIZONTAL HIGH CAPACITY - DUCTED

## Model Series 37FH • Coil Performance Data • Pressure Drop

### Unit Size 12

Chilled Water Pressure Drop

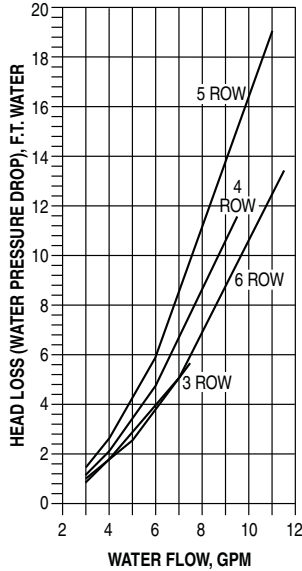

Hot Water Pressure Drop

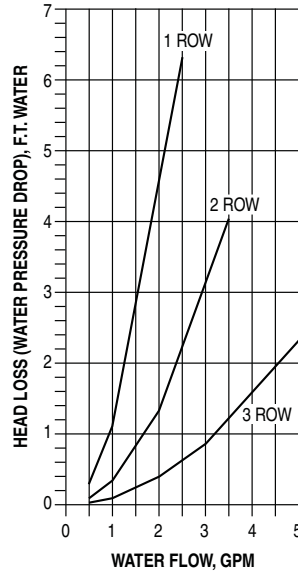

Chilled and Hot Water Air Pressure Drop

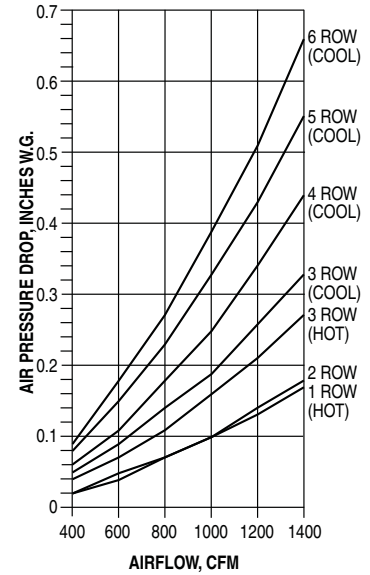

**Metric Conversion Factors:**

1. Water Flow (liters per second)  
l/s = gpm x 0.6309
2. Water Head Loss (kilopascals):  
kPa = ft. w.g. x 2.9837
3. Airflow Volume (liters per second)  
l/s = CFM x 0.472

4. Air Pressure Drop (Pascals):  
Pa = in. w.g. x 248.6
5. Heat (kilowatts):  
kW = Mbh x 0.293
6. Air Temperature Rise.  
 $ATR = 927 \times \frac{Mbh}{CFM}$

7. Water Temp. Drop.  
 $WTD = 2.04 \times \frac{Mbh}{GPM}$

## Model Series 37FH • Suggested Specifications

### 1. General

Furnish and install Engineered Comfort Model 37FH Series High Performance Horizontal Fan Coil Units where indicated on the plans and in the specifications.

### 2. Construction

a. All units shall be Direct Drive – Draw Through configuration and completely factory assembled, tested and shipped as one piece. All units shall be capable of meeting or exceeding the scheduled capacities for cooling, heating and air delivery. All unit dimensions, for each model and size, shall be considered maximums. Units shall be UL or ETL, listed in compliance with UL 1995, and be certified as complying with the latest edition of AHRI Standard 440. Must meet the requirements of NFPA 90A and UL 181.

b. All unit chassis shall be fabricated of heavy gauge galvanized steel panels able to meet 125-hour salt spray test per ASTM B-117. All panels surrounding the coil shall be insulated with 3/4" (19) thick closed cell fiber-free liner and rated for air velocity of 6000 f.p.m. Insulation must meet all requirements of ASTM C1071 (including C665), UL 181 for erosion, and carry a 25/50 rating for flame spread/smoke developed per ASTM E-84, UL 723 and NFPA 90A. All other panels, surrounding the units, must also be acoustically and thermally insulated with a minimum of 3/4" (19) insulation with dual density insulation fiber glass insulation where all exposed edges are coated to prevent air erosion.

c. Unit cabinet shall have side and bottom full size access panels for ease of maintenance and service and motor blower removal. Access panels shall be attached to casing with screws.

#### Optional

- Aluminum foil-faced insulation (steri-liner), meets ASTM Standards C-665 and C-1136 for biological growth in insulation. All exposed edges shall be sealed to prevent any fibers from reaching the air stream.

- Close cell fiber-free liner. Insulation shall conform to UL 181 for erosion and NFPA 90A for fire, smoke and melting, and comply with a 25/50 Flame Spread and Smoke Developed Index per ASTM E-84 or UL 723. Additionally, insulation shall comply with Antimicrobial Performance Rating of 0, no observed growth, per ASTM G-21.

- Perforated metal with steri-liner.

4. Casing leakage shall not exceed 2% of rated airflow @ .5" w.g. (125 Pa).

5. Unit shall be draw through type with fan dynamically balanced, forwardly curved; DWDI centrifugal type constructed of 18-gauge zinc coated galvanized steel for corrosion resistance. The fan assembly shall be easily removable for servicing the motor and blower at, or away from the unit. The entire fan assembly shall be able to come out of the unit by removing four nuts per fan and disconnecting the motor(s) wires.

6. Motor shall be direct drive, isolated from blower and fan housing in at least four (4) locations with rubber isolators to eliminate any motor vibration being transmitted to the fan housing and duct. Motor shall be capable to be serviced through the bottom or side panel. Provide isolation between fan motor assembly and unit casing in at least four (4) locations to eliminate any vibration from the fan to the terminal unit casing. Motors shall be high efficiency, permanently lubricated sleeve bearing. Single speed motors are not acceptable. Motor wires shall be brought into external hinged door control enclosure to facilitate wiring and service. Motors shall be EPIC ECM™, Electronic Commutated Motors with UL and CSA listed automatic reset thermal overload protection and factory-programmed and run-tested in assembled units with fully variable speed capability.

The motor designed for use with single phase power shall have a controller mounted in a control box with a built-in integrated user interface. If adjustments are needed, motor parameters can be adjusted without factory service personnel at the motor control board. Motors shall soft-ramp to programmed specific to

minimize the acoustics due to sudden speed changes. Motors can be operated at the established range of airflows with a factory or field-supplied variable speed controller. All motors have integral thermal overload protection with a maximum ambient operating temperature of 104°F (40°C). Motors are capable of starting at 50 percent of rated voltage and operating at 90 percent of rated voltage on all speed settings. Motors can operate up to 10 percent over voltage.

### 7. Sound

Units shall have discharge and radiated sound power levels published and tested in accordance with AHRI Standard 880.

### 8. Coils

a. All water coils shall be AHRI 410 certified and tagged with an AHRI 410 label. All coils shall be pressure tested under water at 1.5 times the working pressure classification indicated in the Contract Documents, but the test pressure in no case shall be less than 300 psig. Coils shall have 1/2" O.D. seamless copper tubes, and collared and corrugated aluminum fins. Tube wall thickness of 0.016 to be standard. Coil frames shall be constructed of minimum G-90 galvanized steel. Water velocity in the tubes shall not exceed eight (8) feet per second and the coil face velocity shall not exceed 500 fpm (2.5 m/s).

b. For 4-pipe system a separate heating coils shall be furnished in the reheat position as standard.

c. Coils, header and drain pan shall be provided in a fully insulated integral casing with 3/4" (19) fiber-free/foam insulation to increase thermal efficiency and reduce casing leakage.

#### Optional

- For 4-pipe system a separate heating coils shall be furnished in the preheat position as standard.

- Coil tube wall thickness of 0.025" (0.635).

- All coils with piping packages shall be provided with a manual air vent fitting to reduce potential air locks within coil.

- All coils shall be provided with an auto air vent fitting to allow for coil venting.

### 9. Drain Pans

a. Primary condensate drain pans shall be heavy gauge galvanized steel, and extend under the entire cooling coil. Drain pans shall be of one-piece construction, have at least 1" (25) height side and be positively sloped for condensate removal.

b. The drain pan shall be externally insulated with minimum 3/8" (10) thick fire retardant, closed cell foam insulation. The insulation shall carry no more than a 25/50 Flame Spread and Smoke Developed Rating per ASTM E-84 and UL 723 and an Antimicrobial Performance Rating of "0", no observed growth, per ASTM G-21.

#### Optional

- Provide a primary drain pan constructed entirely of heavy gauge stainless steel for superior corrosion resistance. Stainless steel drain pans shall be externally insulated and meet or exceed the requirements stated above.

- Provide a secondary drain connection on the primary drain pan for condensate overflow.

- Provide a condensate overflow switch in the primary drain pan for condensate overflow.

10. Standard units can be ordered without filters.

#### Optional Filter

- Unit to be furnished with a minimum 1" (25) nominal glass fiber throwaway filter. Filters shall be tight fitting to prevent air bypass.

- Provide unit with 2" (52) pleated filters rated at 25-30% efficiency and MERV 8 or 13 based on ASHRAE 52.2

- Unit shall be furnished with the FFR Ducted Filter Rack to facilitate the installation of inlet duct. FFR Filter Rack shall have hinged door flap with latch on the side and bottom to facilitate filter replacement.

.

## Model Series 37FH • Suggested Specifications (continued)

### 11. Electrical

Units shall be furnished with a hinged door control enclosure and wired single point power connection. All power and control wiring shall conform to National Electric Code Standards. Within the control enclosure it shall include all required devices, including but not limited to, service switch, relay, control power transformers and control packages, low voltage remote shutdown relays, etc.

### 12. Electric heat

- a. Furnish an electric resistance heating assembly as an integral part of the fan coil unit, with the heating capacity, voltage and kilowatts scheduled. The heater assembly shall be designed and rated for installation on the fan coil unit and be located in the unit as to not expose the fan assembly to excessive leaving air temperatures that could affect motor performance.
- b. The heater and unit assembly shall be listed for zero clearance and meet all NEC requirements, and be ETL listed with the unit as an assembly in compliance with UL 1995. A NEMA 1 enclosure with hinges shall be placed at the side of the fan coil to provide easy access. All motor wiring and heater terminates in the enclosure for single point electrical connection.
- c. All heating elements shall be open coil high grade Class A 80/20 nickel/chrome element wire mounted in ceramic insulators and located in an insulated heavy gauge galvanized steel housing. All elements shall terminate in a machine staked stainless steel terminal secured with stainless steel hardware for corrosion resistance. The element support brackets shall be spaced no greater than 3-1/2" (89) on center. All internal wiring shall be rated for 221°F (105°C) minimum. All heaters shall include over temperature protection consisting of an automatic reset primary thermal limit. All heaters shall be single stage unless noted otherwise on the plans. All units with electric heat shall be provided with an incoming line power distribution block, designated to accept single point power wiring capable of carrying 125% of the calculated load current.
- d. A Class 2 transformer shall be provided for low voltage control. All devices shall be serviceable through the hinged enclosure and without removing heating element from the unit.

#### Optional

- Heating coils shall be controlled with the SCR option and proportional control to provide infinite heater control.
- 2 Stage Electric Heat shall be provided.
- Toggle Disconnect.
- Door Interlocking disconnect switch.
- Quieter operation option available.
- Power circuit fusing.

#### Dust tight control enclosure.

- Manual reset secondary high limit.
- Positive pressure air flow switch.
- Electronic air proofing with EPIC ECM.

### 13. Piping – Valve Packages

#### As optional

- Provide a factory assembled and installed valve piping package in a fully insulated integral casing with 3/4" (19) fiber-free/foam insulation to increase thermal efficiency and reduce casing leakage. Valve package shall consist of a 2 or 3 way, on/off, motorized electric control valve and two ball isolation valves. Maximum entering water temperature on the control valve shall be 200°F (93.3°C) with a maximum operating pressure of 300 PSIG. Refer to Specification Section titled, "Pipes, Valves, Fittings and Accessories" for optional and accessories specifications.
- Provide modulating control valve (fail-in-place) in lieu of standard 2-position control valve with factory assembled valve piping package.
- Provide a fixed-auto flow control device for each piping package with the specific gpm specified for the unit on the schedule.

- Provide an adjustable flow control device for each piping package.
- Provide unions and/or pressure/temperature ports for each piping package.

### 14. Ultraviolet Light

As optional each unit shall be supplied with Ultraviolet Lights for disinfection for HVAC mold, bacteria & odor control. Fixture assembly to be installed at the coil discharge (downstream of the coil), between the coil and fan housing. Fixtureless lamps are to be installed in sufficient quantity and in such a manner so as to provide an equal distribution of UVC energy. The minimal UVC energy striking a surface shall be sufficient to continuously destroy a monolayer of mold and bacteria in less than six hours when at 55-135°F (12.7-57°C). Fixture shall be electrically terminated to within factory supplied ballast housings to meet NEC and local codes. Lamps shall be mounted to irradiate the intended surface(s) as well as all of the available line of sight airstream by proper placement and incident angle reflection.

To protect maintenance personnel, all access panels and doors to the UVC assembly and/or within view of the UVC assembly must include mechanical interlock switch(es) to insure that the UVC assembly will be de-energized when any of these accesses are opened. For complete safety, the UVGI equipment shall have been tested, Listed and labeled as an integral part of the fan coil unit by the fan coil manufacturer, no exceptions.

### 15. Controls

Controller and sensors provided by others but mounted and wired during unit assembly at the fan coil manufacturing facility.

NOTES:

**B**

**HORIZONTAL HIGH CAPACITY - DUCTED**