



UNDERFLOOR AIR DISTRIBUTION PRODUCTS

UNDERFLOOR AIR DISTRIBUTION PRODUCTS**SECTION****GENERAL PRODUCT OVERVIEW****A****FLOOR "SWIRL" DIFFUSERS****B****VAV LINEAR FLOOR DIFFUSERS****C****UNDERFLOOR FAN POWERED TERMINAL UNITS****D****UNDERFLOOR FAN COIL UNITS****E****ENGINEERING GUIDE AND INDEX****F**

Catalog January 2007. Printed in Canada.

Copyright ©2007 by Nailor Industries Inc. All rights reserved. No part of this catalog may be reproduced or transmitted in any form or by any means, electronic or mechanical, including photocopying and recording, or by any information storage and retrieval system without permission in writing from Nailor Industries Inc. In this catalog the terms of "Nailor Industries Inc.", "Nailor", "Nailor Industries" or "Nailor International Group" are synonymous and may be interchangeable for context or clarity. Nailor Industries Inc. pursues a policy of continuous product development and we therefore reserve the right to change any of the information in this publication without notice. Contact your Nailor representative to verify current product details.



Today, most people involved in the HVAC industry around the world are familiar with Nailor Industries Inc. and our comprehensive line of Air Distribution, Air Control and Air Terminal Unit products. However, many may not know that the company had humble beginnings.

The company commenced operations at a small facility in Toronto, Canada manufacturing a single air control device. Michael T. Nailor (President and CEO) started with the founding principle that the company would be customer focused and service orientated, dedicated to fulfilling the need for high quality, competitively priced products, delivered to our customers on schedule.

Nailor management has maintained strict adherence to the 'Superior Customer Service' philosophy for more than 30 years and as a result, the company has been rewarded with a continually increasing demand for our products. An ever expanding product offering includes air control and fire/smoke dampers, a complete line of grilles, registers and diffusers as well as fan coil units, fan powered terminal units, silencers, and electric duct heaters that exceed industry standard design and performance specifications.

Recently, Nailor International Group has expanded their already outstanding repertoire of companies with Thermal Corporation – manufacturers of custom air handling equipment, and Manufactured Air Products – a complete line of top quality air distribution and air control products that are available through stocking wholesalers across North America.

Today, with Group International Headquarters in Houston, Texas, the company has ten manufacturing plants totaling over 600,000 square feet strategically located in three countries to service the North American, European, Middle Eastern and Asian Pacific markets. An international distribution network of representatives in most major cities work together to not only meet but exceed the expectations of clients, engineers and customers around the world.

As a private company, employing a staff of dedicated professionals, Nailor Industries Inc. is prepared to set new benchmarks for service and quality as the company continues to grow and remain the source for your . . .

"Complete Air Control and Distribution Solutions."

www.nailor.com

GENERAL PRODUCT OVERVIEW



Nailor
Industries Inc.

GENERAL PRODUCT OVERVIEW

Nailor provides a complete line of products with industry leading performance and quality features uniquely suited to underfloor air distribution systems. Architecturally appealing raised access floor diffusers for interior and perimeter zones as well as VAV diffusers are engineered to provide superior comfort levels while allowing maximum flexibility for occupant adjustments. Our super quiet fan powered terminal units and fan coil units are specifically designed for low height underfloor applications. Eminently suitable for the most demanding applications they incorporate ultra-high efficiency features such as ECM™ motors, our patented EPIC Fan Technology® and low pressure drop inclined opposed blade dampers.

FLOOR "SWIRL" DIFFUSER

Model NFD Floor "Swirl" Diffusers are designed for use in raised access floor air distribution systems, where the floor cavity is used as a pressurized supply air plenum. The NFD core design produces a low velocity helical "swirl" discharge air pattern. The design achieves high induction rates of room air which optimizes mixing for maximum comfort conditions.

An architecturally appealing face design compliments any contemporary decor and is available as standard in a gray or black finish as well as a wide variety of custom colors.

Allowing extreme flexibility in space planning, the diffuser, once installed in the access floor panel, can be quickly relocated to accommodate changing conditions and floor layouts.

Model NFD

See page B3

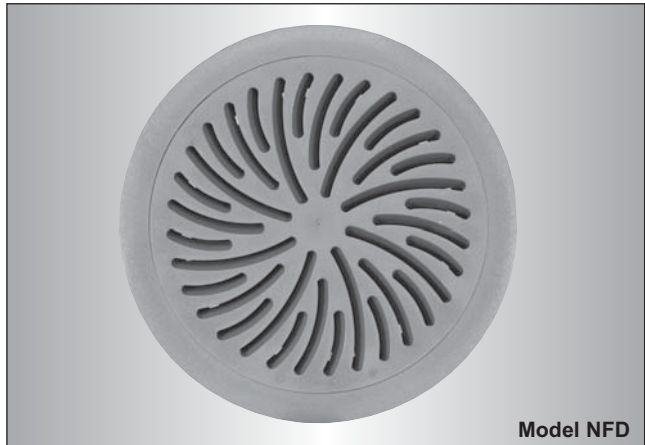

Model NFD

ALUMINUM FLOOR "SWIRL" DIFFUSER

Model ANFD Aluminum Floor "Swirl" Diffusers are designed for use in raised access floor air distribution systems, where the floor cavity is used as a pressurized supply air plenum. The specially designed ANFD core produces a low velocity helical "swirl" air pattern. This design achieves high induction rates of room air which optimizes mixing for maximum comfort conditions.

An architecturally appealing face design compliments any contemporary decor and is available as standard in a gray or black textured finish as well as a wide variety of custom colors.

Allowing extreme flexibility in space planning, the diffuser, once installed in the access floor panel, can be quickly relocated to accommodate changing conditions and floor layouts.

Model ANFD

See page B7



Model ANFD

FLOOR ACCESS OUTLET

Model NFA Floor Access Outlets are designed for use in raised access floor air distribution systems and compliments the Model NFD Floor "Swirl" Diffuser. It provides a functional means of through-the-floor routing of electrical, telephone and data communication cables.

An architecturally appealing face design compliments any contemporary decor and is available as standard in a gray or black finish as well as a wide variety of custom colors.

Allowing extreme flexibility in space planning, the floor access outlet, once installed in the access floor panel, can be quickly relocated to accommodate changing conditions and floor layouts.

Model NFA

See page B12

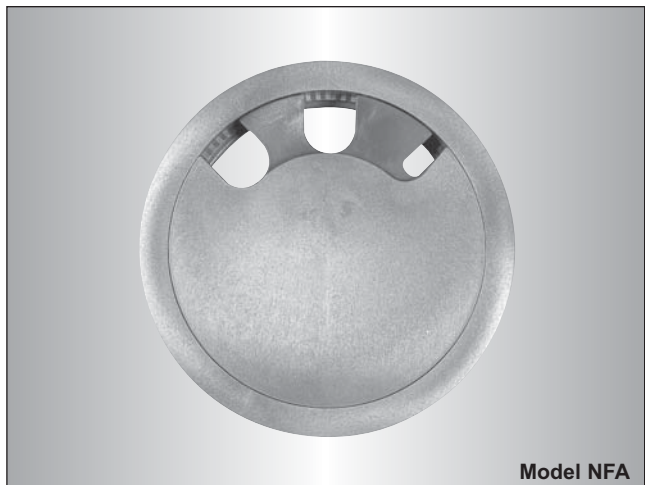

Model NFA

A

GENERAL PRODUCT OVERVIEW

VAV FLOOR "SWIRL" DIFFUSER WITH ACTUATOR

Model NFD-VAV Floor "Swirl" Diffusers with actuators are designed for use in raised access floor air distribution systems, where the floor cavity is used as a pressurized supply air plenum. An integral modulating actuator provides variable air volume control in cooling applications for precise zone temperature control. The NFD-VAV core design produces a low velocity helical "swirl" discharge air pattern. The design achieves high induction rates of room air, which optimizes mixing for maximum comfort conditions.

An architecturally appealing face design compliments any contemporary decor and is available as standard in a gray or black finish as well as a wide variety of custom colors.

Allowing extreme flexibility in space planning, the diffuser, once installed in the access floor panel, can be quickly relocated to accommodate changing conditions and floor layouts.

Model NFD-VAV

See page B14



Model NFD-VAV



Model ANFD-VAV

VAV ALUMINUM FLOOR "SWIRL" DIFFUSER WITH ACTUATOR

Model ANFD-VAV Aluminum Floor "Swirl" Diffusers with actuators are designed for use in raised access floor air distribution systems, where the floor cavity is used as a pressurized supply air plenum. An integral modulating actuator provides variable air volume control in cooling applications for precise zone temperature control. The core design produces a low velocity helical "swirl" discharge air pattern. The design achieves high induction rates of room air, which optimizes mixing for maximum comfort conditions.

An architecturally appealing face design compliments any contemporary decor and is available as standard in a gray or black textured finish as well as a wide variety of custom colors.

Allowing extreme flexibility in space planning, the diffuser, once installed in the access floor panel, can be quickly relocated to accommodate changing conditions and floor layouts.

Model ANFD-VAV

See page B17

VAV LINEAR FLOOR DIFFUSER WITH ACTUATOR

Model Series NLD VAV Linear Floor Diffusers with actuators are designed for use in raised access floor air distribution systems. High quality, heavy duty, extruded aluminum linear grilles are featured providing an architecturally appealing face design that compliments contemporary decor. Heavy gauge steel plenums incorporate a large dust/dirt collection area that catches anything that might fall through the diffuser face.

Model Series NLD provides variable air volume heating or cooling control for ducted or non-ducted applications. A 90° rotation low leakage damper and integral modulating actuator provide precise airflow control.

Models NLD-VC, NLD-VH, NLD-VCD, NLD-VHD, NLD-VCHD, and NLD-VHCD

See page C3



Model Series NLD

VAV LINEAR FLOOR DIFFUSER WITH ACTUATOR

Model Series NLYD VAV Linear Floor Diffusers with actuators are designed for use in raised access floor air distribution systems. High quality, heavy duty, extruded aluminum linear grilles are featured providing an architecturally appealing face design that compliments contemporary decor. Heavy gauge steel plenums incorporate a dust/dirt collection area that catches anything that might fall through the diffuser face.

Model Series NLYD provides either variable air volume heating or cooling only control for non-ducted (pressurized access floor) applications. A 90° rotation low leakage damper and integral modulating actuator provide precise airflow control.

Models NLYD-VC, and NLYD-VH

See page C10



Model Series NLYD

A

GENERAL PRODUCT OVERVIEW

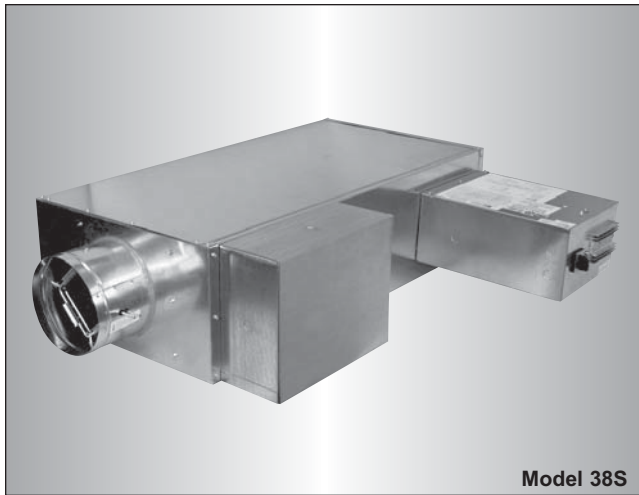

Model 38S

UNDERFLOOR FAN POWERED TERMINAL UNITS

Model Series 38S Underfloor Fan Powered Terminal Units are specially engineered to meet the requirements of the most demanding underfloor applications where premium quality design and performance characteristics are desired. Features include an inclined opposed blade damper and our multi-point averaging 'Diamond Flow' sensor to provide precise airflow control and excellent sound performance. Compact, low profile unit casings, designed to accommodate the floor pedestal layout, feature convenient access to all components.

Designed to optimize energy efficiency the standard units feature ultra-high efficiency EPIC™/ECM motor technology. Additional options include electric or hot water supplementary heat, and various 'IAQ' linings including a solid metal liner.

Models 38S, 38SW and 38SE

See page D3

UNDERFLOOR FAN COIL UNITS

Model Series 38F Underfloor Fan Coil Units are specially engineered to meet the requirements of the most demanding underfloor applications where premium quality design and performance characteristics are desired. These compact low profile units feature excellent sound performance, independently tested and certified. Heavy gauge unit casings, designed to accommodate the floor pedestal layout, feature convenient access to all components.

Designed to optimize energy efficiency the standard units feature ultra-high efficiency EPIC™/ECM motor technology. Additional options include two or four pipe water coils, electric heating coils, and various 'IAQ' linings including a solid metal liner.

Models 38F, 38FZ, 38FW, 38FZW, 38FE, 38FZE, 38FWE and 38FZWE

See page E3

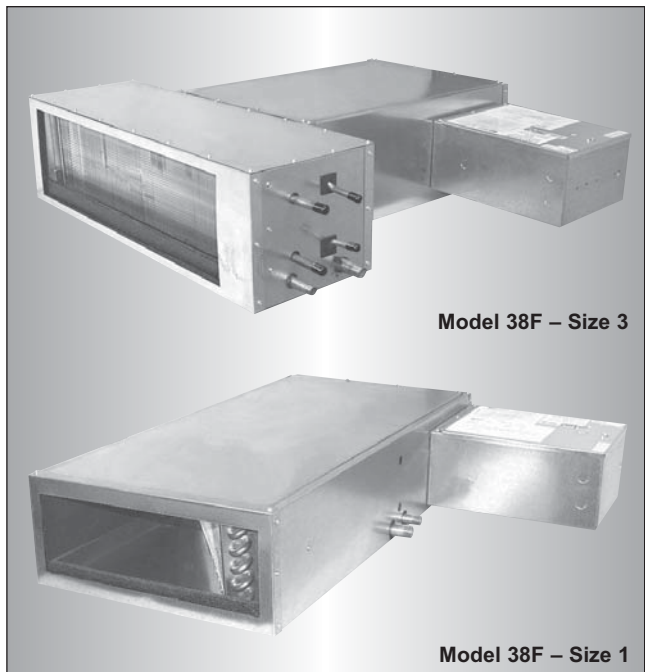

Model 38F – Size 3

Model 38F – Size 1

CURVED SLOT MEDICAL
THROW DIFFUSER
CORE
7 3/4" (197) DIA.

MANUALLY ADJUSTED
FLOW REGULATOR
DAMPER G/W
ADJUSTABLE MINIMUM
VOLUME STOP (OPTIONAL)
REQUIRES DUST/DIRT
COLLECTION BASKET

DUST/DIRT
COLLECTION BASKET
(OPTIONAL)

TRIM DIA.

FLOOR "SWIRL" DIFFUSERS

 **Nailor**
Industries Inc.

Contents

	Page No.
Floor "Swirl" Diffusers	
NFD - Polycarbonate Plastic - High Performance	B3
NFD/NFD-VAV - Performance Data	B5
ANFD - Cast Aluminum - High Performance	B7
ANFD/ANFD-VAV - Performance Data	B9
NFD/ANFD - Installation Instructions for Floor "Swirl" Diffusers	B11
NFA - Polycarbonate Plastic - Electrical and Communication Cable Outlet	B12
VAV Floor "Swirl" Diffusers	
NFD-VAV - Polycarbonate Plastic - High Performance - Variable Air Volume	B14
NFD-VAV - Control Diagram	B15
ANFD-VAV - Cast Aluminum - High Performance - Variable Air Volume	B17
ANFD-VAV - Control Diagram	B18

FLOOR "SWIRL" DIFFUSER

- FIXED HELICAL PATTERN
- ROUND, FLOOR MOUNTED
- HIGH PERFORMANCE
- POLYCARBONATE PLASTIC

Model:
NFD

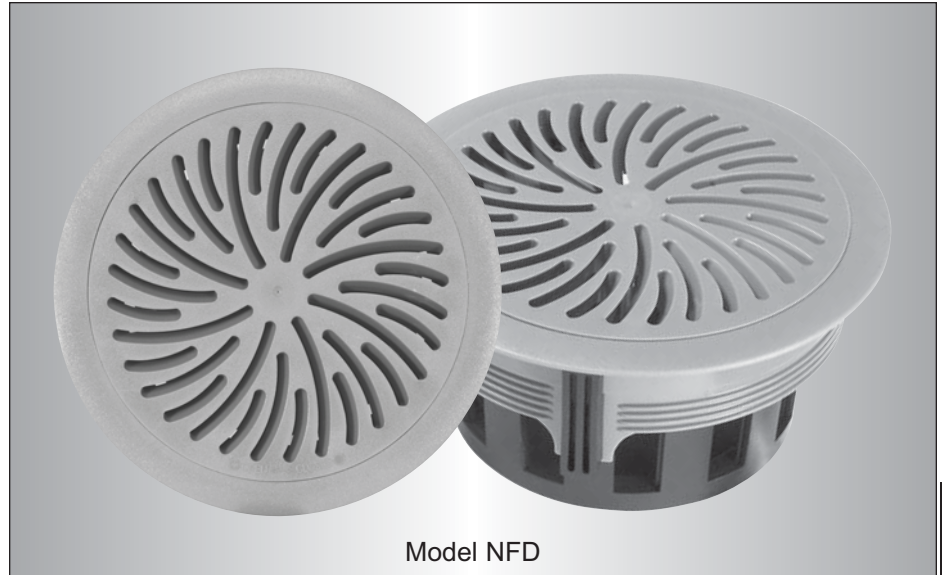

The **Nailor Model NFD Floor "Swirl" Diffusers** are designed for use in raised access floor air distribution systems, where the floor cavity is used as a pressurized supply air plenum. The NFD core design produces a low velocity helical "swirl" discharge air pattern. This design achieves high induction rates of room air, which optimizes mixing for maximum comfort conditions.

An architecturally appealing face design compliments any contemporary decor and is available as standard in a gray or black finish as well as a wide variety of custom colors.

Allowing extreme flexibility in space planning, the diffuser, once installed in the access floor panel, can be quickly relocated to accommodate changing conditions and floor layouts.

FEATURES:

- Constructed of high impact, polycarbonate plastic which complies with UL Standard 94-5V for flammability.
 - Nominal size 8" (203) dia. Low profile design.
 - Dust/dirt collection basket catches anything that might fall through the diffuser face and is removable for cleaning.
 - Optional flow regulator damper is adjustable without removing the diffuser core, features visual open/closed indication and includes an adjustable min. volume stop.
 - Low pressure drop core/damper assembly design.
 - Core lies flush with trim ring
- flange, with or without damper.
 - Rugged trim ring design secures carpet and prevents edges from fraying.
 - Unique adjustable mounting clamp design adapts to any floor panel thickness and provides simple and secure installation. Permits installation from above the floor without removal of the floor panel or carpet.
 - Optional underfloor mounting ring available.
 - Standard finish is GR Gray or BK Black core and trim ring. Damper and basket are black. Other finishes are available.

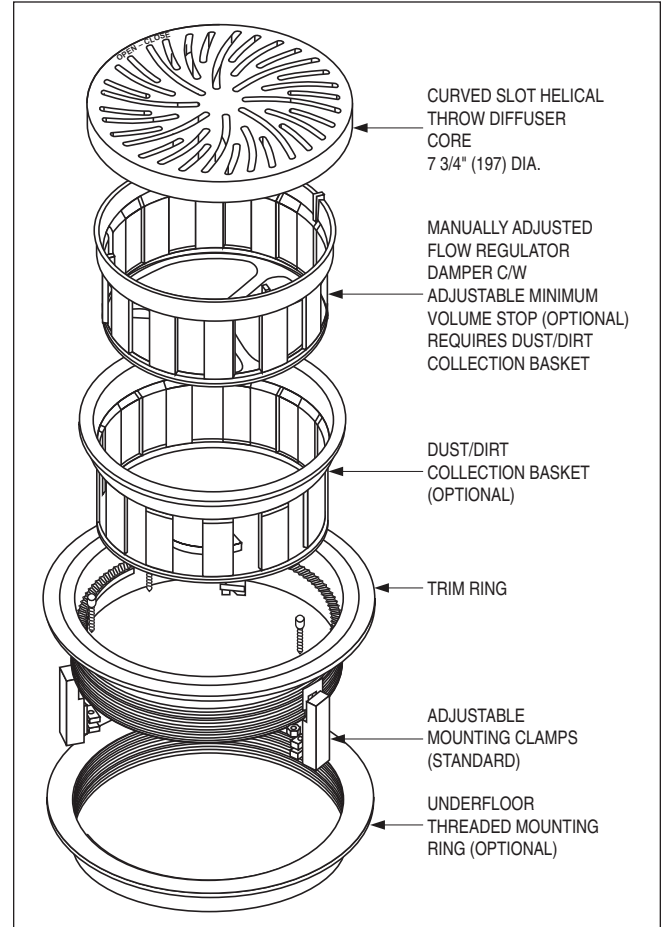
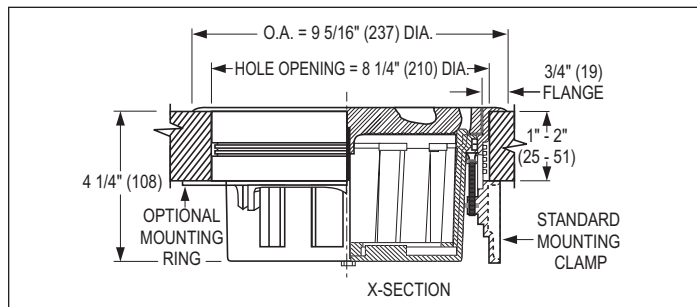

HOW TO SPECIFY OR TO ORDER

(Show complete Model Number and Size, unless "Default" is desired).

Floor "Swirl" Diffuser – Model NFD

NFD - 08 - TR - BDA - MC - GR

BASE MODEL (CORE)

- Floor "Swirl" Diffuser NFD

NOMINAL SIZE

- 8" (203) nom. dia. 08
(default)

TRIM RING

- Standard (default) TR
- None OO
(Option only when
core only is required)

BASKET / DAMPER *

- Basket / Damper BDA
 attached to core (default)
- Basket / Damper BDL
 loose
- Basket only BOO
- None OOO

FINISH

- Gray GR
- Black BK
- Special (custom color
 by architect) SP

MOUNTING

- Mounting Clamps MC
 (default)
- Mounting Ring MR
- None OO

B
FLOOR "SWIRL" DIFFUSERS

Note:

Model NFD: Floor "Swirl" Diffuser

1.* Basket/damper and mounting options MC and MR cannot be ordered without trim ring.

Example: NFD - 08 - TR - BDA - MC - GR

SUGGESTED SPECIFICATION:

Furnish and install **Nailor Model NFD Floor "Swirl" Diffusers** of the size and type shown on the plans and air distribution schedules. The diffusers shall be constructed entirely of high impact polycarbonate plastic which complies with UL Standard 94-5V for flammability. The core design shall produce a low velocity helical "swirl" discharge air pattern maximizing induction and comfort in the occupied zone. The diffusers shall incorporate a removable dust/dirt collection basket to catch anything that might fall through the diffuser face. Three universally adjustable mounting clamps shall be provided for each diffuser to permit installation from above the floor without removal of the floor panel or carpet. A flow regulator damper, adjustable without removing the diffuser core, shall be provided with visual open/closed indication and include an adjustable minimum volume stop.

Finish on visible surfaces shall be (GR Gray or BK Black) (other finishes are available).

The manufacturer shall provide published performance data for the diffuser, which shall be tested in accordance with ANSI/ASHRAE Standard 70 –1991.

Performance Data

Models NFD and NFD-VAV

Airflow, cfm	30	40	50	60	70	80	90	100	110	120
Plenum Pressure, inches, w.g.	0.012	0.020	0.029	0.040	0.050	0.063	0.077	0.093	0.108	0.125
Vertical Projection, ft. @ 150, 100, 50 fpm	0.1-0.5-1.2	0.4-1.0-2.0	0.8-1.8-2.8	1.2-2.6-3.5	1.6-3.4-4.2	2.2-4.1-4.8	3.1-4.6-5.3	3.9-5.1-5.8	4.6-5.5-6.2	5.2-5.8-6.6
Horizontal Spread, ft. @ 150, 100, 50 fpm	1.0-1.0-1.5	1.0-1.0-2.0	1.5-1.8-2.7	1.7-2.9-4.1	1.9-4.0-5.5	2.1-4.1-5.8	2.5-3.9-5.7	2.9-3.8-5.5	3.1-3.7-5.4	3.3-3.6-5.3
NC	-	-	-	-	-	-	-	15	18	20

Correction Factor for Return Air Applications: Multiply Plenum Pressure by x 2.65 to determine static pressure drop.

Correction Factors for other supply air temperature differentials.

ΔT (°F)	-6	-8	-10	-12	-14	-16
Projection, ft.	x 1.33	x 1.11	x 1.00	x 0.96	x 0.92	x 0.91
Spread, ft.	x 0.87	x 0.94	x 1.00	x 1.06	x 1.11	x 1.16

Performance Notes:

1. Projection and Spread data were determined in a room with a 11' ceiling height and 10°F ΔT , between supply air and averaged occupied room temperature.
2. Vertical projection (throw) is the maximum height above the floor where terminal velocities of 150, 100 and 50 fpm were observed. Horizontal Spread is the total width of the isovel where terminal velocities of 150, 100 and 50 fpm were observed.
3. Noise Criteria (values) based on 10 dB room absorption, re 10^{-12} watts. Dash (-) in space denotes an NC value of less than 15.
4. Pressure is in inches w.g..
5. Tests conducted with dirt basket/damper installed. Damper fully open. $A_k = 0.104$
6. Data derived from independent tests conducted in accordance with ANSI/ASHRAE Standard 70 – 1991.

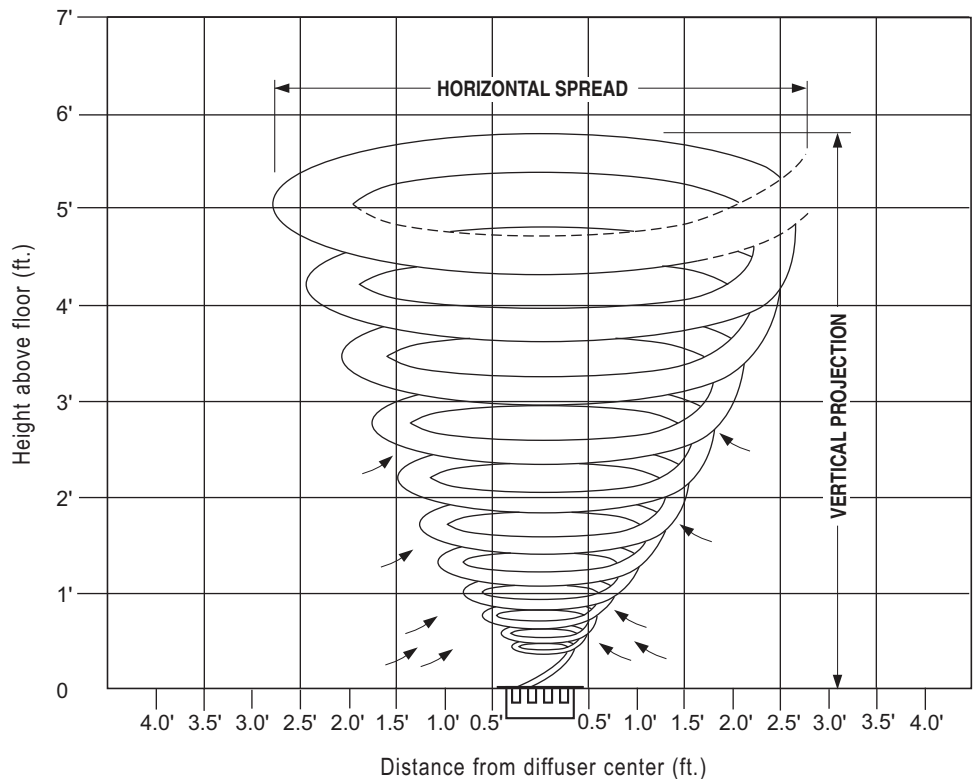

High induction "Swirl" Pattern. 100 cfm supply @10°F ΔT . Outline indicates maximum room air velocity of 50 fpm.

B

FLOOR "SWIRL" DIFFUSERS

Performance Data

Models NFD and NFD-VAV

PERFORMANCE TEST – MODEL NFD @ 100 CFM

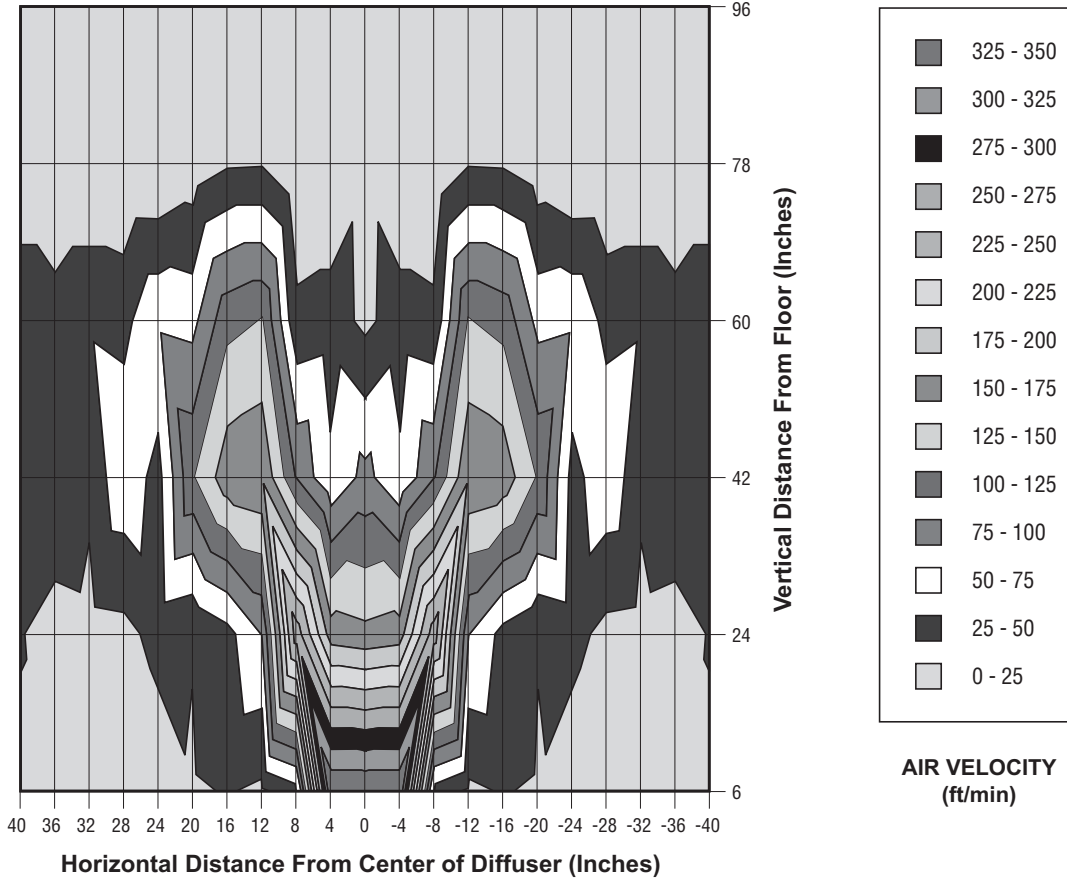

Note: The graph above shows actual air velocities and the associated isovels. This data was obtained in a full scale mock-up test performed on a standard Model NFD @ 100 cfm with a 10°F ΔT.

B

FLOOR "SWIRL" DIFFUSERS

FLOOR "SWIRL" DIFFUSER

- FIXED HELICAL PATTERN
- ROUND, FLOOR MOUNTED
- HIGH PERFORMANCE
- ALUMINUM

Model:
ANFD

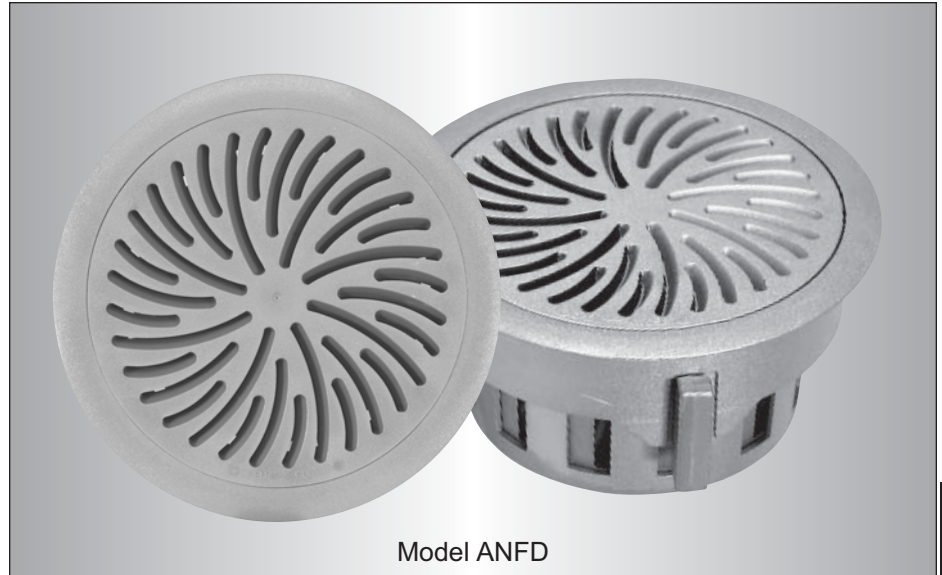

Model ANFD

The **Nailor Model ANFD Floor "Swirl" Diffusers** are designed for use in raised access floor air distribution systems, where the floor cavity is used as a pressurized supply air plenum. The ANFD core design produces a low velocity helical "swirl" discharge air pattern. This design achieves high induction rates of room air, which optimizes mixing for maximum comfort conditions.

An architecturally appealing face design compliments any contemporary decor and is available as standard in a gray or black textured finish as well as a wide variety of custom colors.

Allowing extreme flexibility in space planning, the diffuser, once installed in the access floor panel, can be quickly relocated to accommodate changing conditions and floor layouts.

FEATURES:

- Meets all the requirements of NFPA 90A.
- Cast aluminum construction.
- Nominal size 8" (203) dia. Low profile design.
- Dust/dirt collection basket catches anything that might fall through the diffuser face and is removable for cleaning.
- Optional flow regulator damper is adjustable without removing the diffuser core, features visual open/closed indication and includes an adjustable min. volume stop.
- Low pressure drop core/damper assembly design.
- Core lies flush with trim ring flange, with or without damper.
- Rugged trim ring design secures carpet and prevents edges from fraying.
- Unique adjustable mounting clamp design adapts to any floor thickness and provides simple and secure installation. Permits installation from above the floor without removal of the floor panel or carpet.
- Standard finish is GRT Gray or BKT Black textured baked enamel. Other finishes are available.

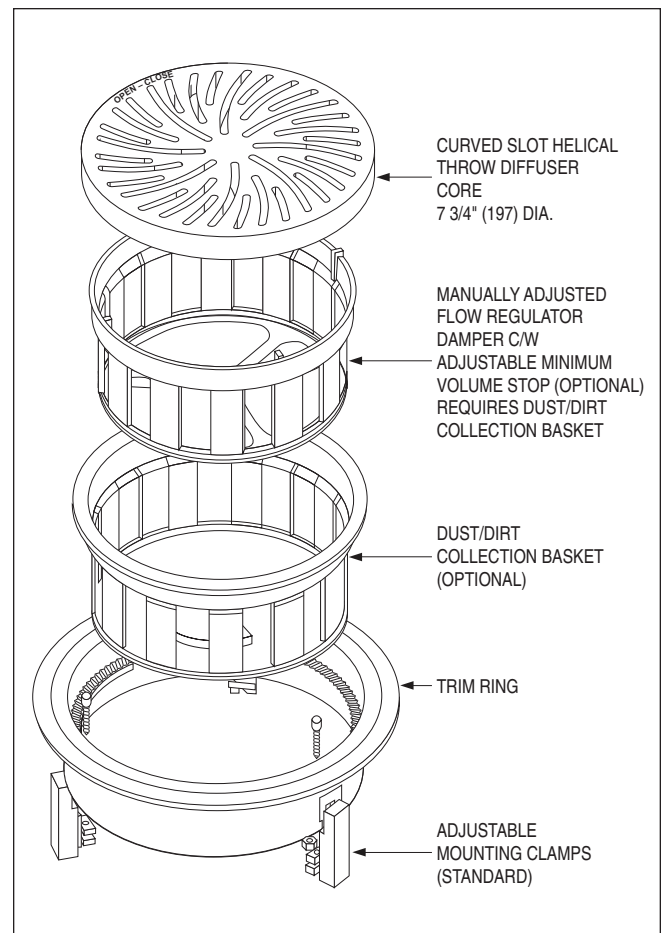
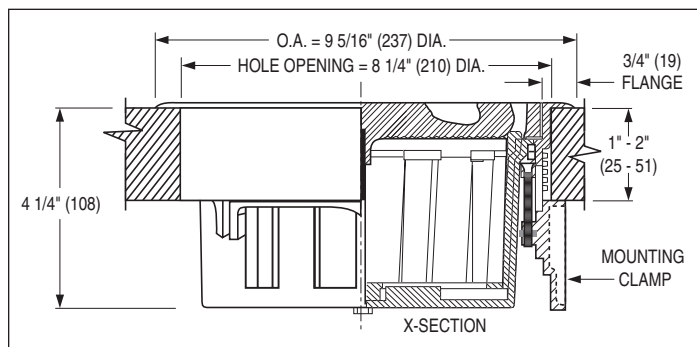

HOW TO SPECIFY OR TO ORDER

(Show complete Model Number and Size, unless "Default" is desired).

Aluminum Floor "Swirl" Diffuser – Model ANFD

ANFD - 08 - TR - BDA - MC - GRT

BASE MODEL (CORE)

- Aluminum Floor "Swirl" Diffuser ANFD

NOMINAL SIZE

- 8" (203) nom. dia. 08
(default)

TRIM RING

- Standard (default) TR
- None OO
(Option only when core only is required)

BASKET / DAMPER *

- Basket / Damper attached to core (default) BDA
- Basket / Damper loose BDL
- Basket only BOO
- None OOO

FINISH

- Gray (textured) GRT
- Black (textured) BKT
- Special (custom color by architect) SPT

MOUNTING

- Mounting Clamps (default) MC
- None OO

B FLOOR "SWIRL" DIFFUSERS

Note:

Model ANFD: Aluminum Floor "Swirl" Diffuser

1.*Basket/damper and mounting clamps MC cannot be ordered without trim ring.

Example: ANFD - 08 - TR - BDA - MC - GRT

SUGGESTED SPECIFICATION:

Furnish and install **Nailor Model ANFD Aluminum Floor "Swirl" Diffusers** of the size and type shown on the plans and air distribution schedules. The diffusers shall be constructed entirely of cast aluminum and meet all the requirements of NFPA 90A. The core design shall produce a low velocity helical "swirl" discharge air pattern maximizing induction and comfort in the occupied zone. The diffusers shall incorporate a removable dust/dirt collection basket to catch anything that might fall through the diffuser face. Three universally adjustable mounting clamps shall be provided for each diffuser to permit installation from above the floor without removal of the floor panel or carpet. A flow regulator damper, adjustable without removing the diffuser core, shall be provided with visual open/closed indication and include an adjustable minimum volume stop.

Finish on visible surfaces shall be (GRT Gray or BKT Black) textured baked enamel (other finishes are available).

The manufacturer shall provide published performance data for the diffuser, which shall be tested in accordance with ANSI/ASHRAE Standard 70 – 1991.

Performance Data

Models ANFD and ANFD-VAV

Airflow, cfm	30	40	50	60	70	80	90	100	110	120
Plenum Pressure, inches w.g.	0.011	0.018	0.027	0.036	0.047	0.059	0.072	0.085	0.100	0.115
Vertical Projection, ft. @ 150, 100, 50 fpm	0.5-0.5-0.5	0.5-0.5-0.5	0.5-0.5-1.0	1.0-1.5-2.0	2.1-2.4-2.8	2.4-2.8-3.4	2.7-3.1-3.9	3.0-3.4-4.4	3.3-3.8-4.9	3.6-4.0-5.3
Horizontal Spread, ft. @ 150, 100, 50 fpm	0.5-1.0-1.5	1.0-1.4-2.1	1.6-1.8-2.7	1.8-2.1-4.6	2.0-2.3-5.8	1.8-2.3-6.4	1.4-1.8-6.5	1.1-1.3-6.7	1.1-1.3-6.8	1.0-1.2-7.0
NC	-	-	-	-	-	-	-	15	18	20

Correction Factor for Return Air Applications: Multiply Plenum Pressure by x 2.65 to determine static pressure drop.

Correction Factors for other supply air temperature differentials.

ΔT (°F)	-6	-8	-10	-12	-14	-16
Projection, ft.	x 1.33	x 1.11	x 1.00	x 0.96	x 0.92	x 0.91
Spread, ft.	x 0.87	x 0.94	x 1.00	x 1.06	x 1.11	x 1.16

Performance Notes:

- Projection and Spread data were determined in a room with a 11' ceiling height and 10°F ΔT , between supply air and averaged occupied room temperature.
- Vertical projection (throw) is the maximum height above the floor where terminal velocities of 150, 100 and 50 fpm were observed. Horizontal Spread is the total width of the isovel where terminal velocities of 150, 100 and 50 fpm were observed.
- Noise Criteria (values) based on 10 dB room absorption, re 10^{-12} watts. Dash (-) in space denotes an NC value of less than 15.
- Pressure is in inches w.g..
- Tests conducted with dirt basket/damper installed. Damper fully open. $A_k = 0.104$
- Data derived from independent tests conducted in accordance with ANSI/ASHRAE Standard 70 – 1991.

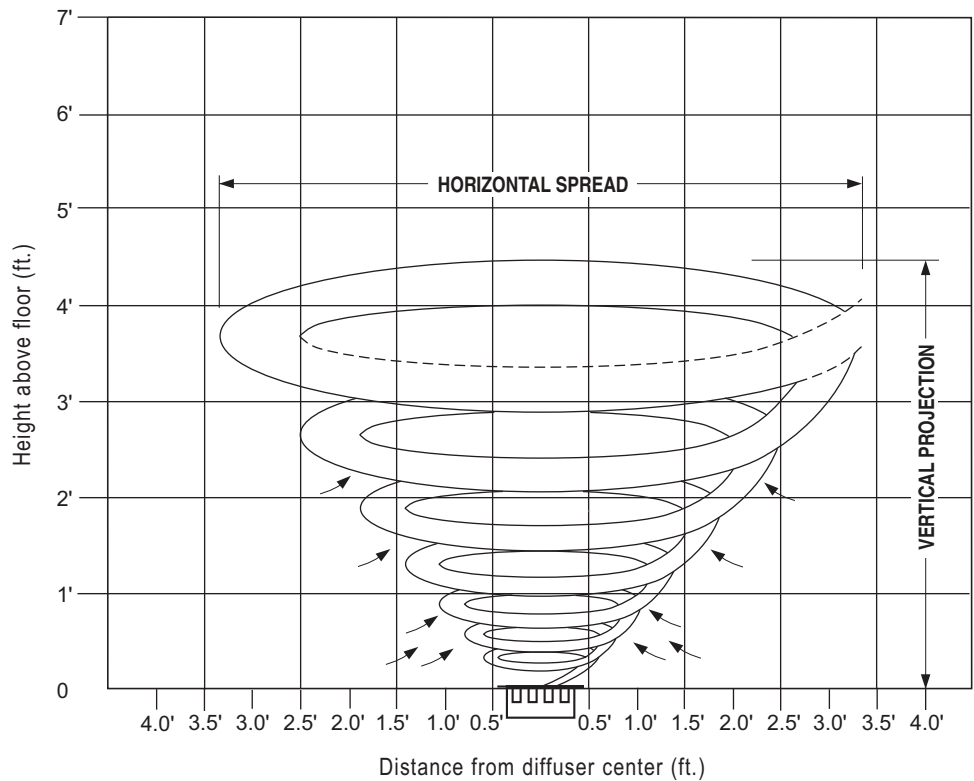

High induction "Swirl" Pattern. 100 cfm supply @10°F ΔT . Outline indicates maximum room air velocity of 50 fpm.

Performance Data

Models ANFD and ANFD-VAV

PERFORMANCE TEST – MODEL ANFD @ 100 CFM

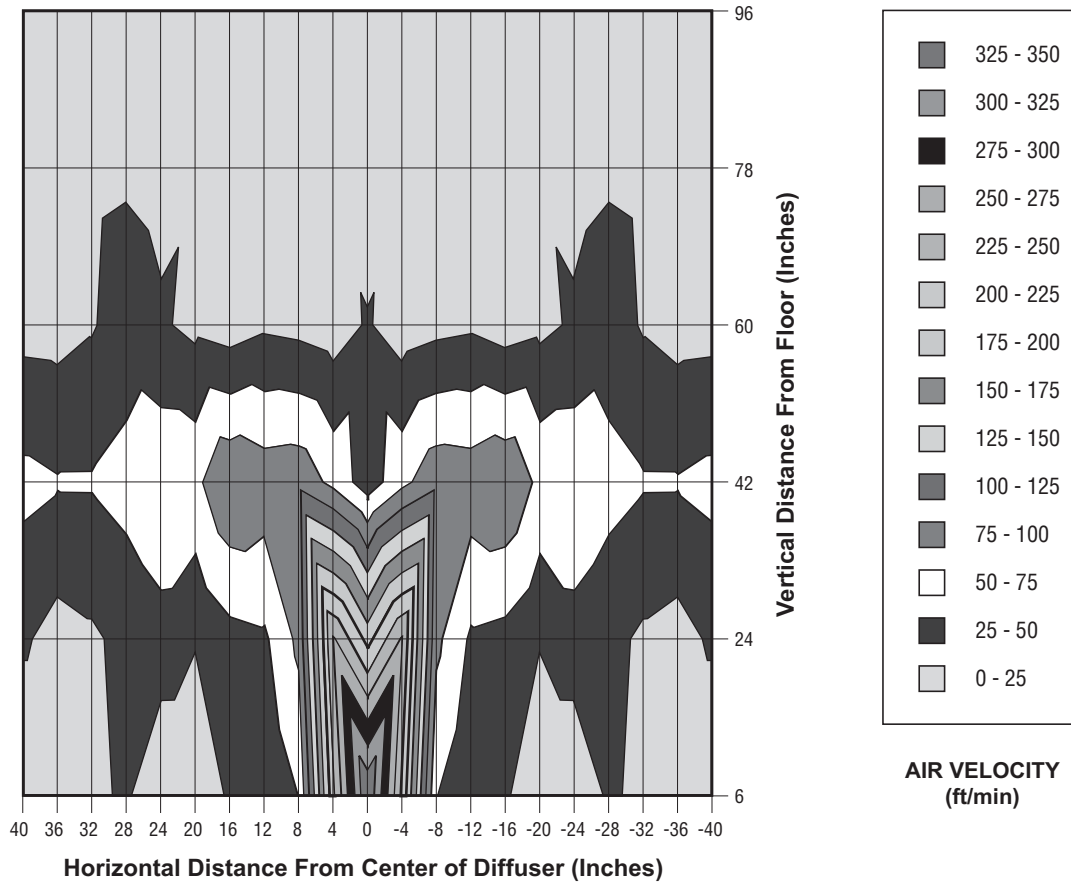

Note: The graph above shows actual air velocities and the associated isovels. This data was obtained in a full scale mock-up test performed on a standard Model ANFD @ 100 cfm with a 10°F ΔT.

B
FLOOR "SWIRL" DIFFUSERS

Installation Instructions

Models NFD and ANFD • Floor "Swirl" Diffusers

OPEN-CLOSE ADJUSTMENT

SIMPLY ROTATE THE DIFFUSER CORE TO CHANGE THE AIRFLOW. MINIMUM VOLUME STOP MAY BE ADJUSTED AS REQUIRED (5/32" (4) ALLEN KEY).

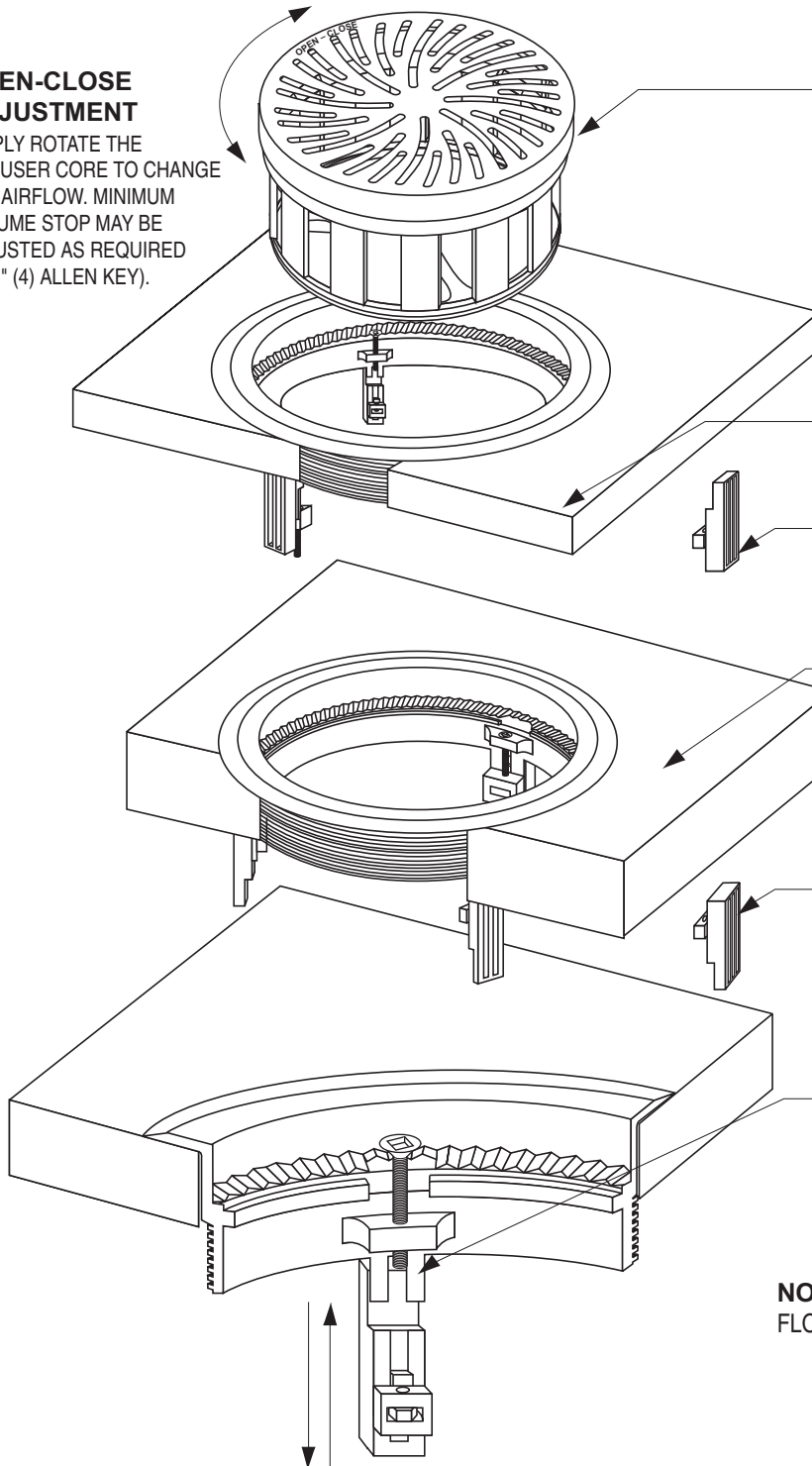

CORE ASSEMBLY: DIFFUSER CORE FLOW REGULATOR AND COLLECTION BASKET

SIMPLY DROP IN PLACE AFTER TRIM RING INSTALLATION. ENSURE THE THREE LUGS ON THE BASKET ALIGN WITH THE RECESSES IN THE TRIM RING SO THAT THE FACE OF THE CORE IS FLUSH WITH THE TRIM RING.

TRIM RING ASSEMBLY OPTION 1 WHEN FLOOR IS 1/4" (6) – 1 1/2" (38)

INSTALL THE THREE MOUNTING CLAMPS WITH THE LONG EXTENSION FACING UPWARDS.

ASSEMBLY OPTION 2 WHEN FLOOR IS 1 1/2" (38) – 2" (51)

INSTALL THE THREE MOUNTING CLAMPS WITH THE SHORT EXTENSION FACING UPWARDS.

DETAIL OF 1ST ASSEMBLY OPTION

NOTE: HOLE OPENING REQUIREMENT IN FLOOR FOR INSTALLATION 8 1/4" (210) DIA.

FLOOR ACCESS OUTLET

- ELECTRICAL AND COMMUNICATION CABLE OUTLET
- ROUND, FLOOR MOUNTED
- POLYCARBONATE PLASTIC

Model:
NFA



B

The **Nailor Model NFA Floor Access Outlet** is designed for use in raised access floor air distribution systems and compliments the **Model NFD Floor "Swirl" Diffuser**. It provides a functional means of through-the-floor routing of electrical, telephone and data communication cables.

An architecturally appealing face design compliments any contemporary decor and is available as standard in a gray or black finish as well as a wide variety of custom colors.

Allowing extreme flexibility in space planning, the floor access outlet, once installed in the access floor panel, can be quickly relocated to accommodate changing conditions and floor layouts.

FEATURES:

- Constructed of high impact, polycarbonate plastic which complies with UL Standard 94-5V for flammability.
- Nominal size 8" (203) dia.
- Grommet holes will accept one or two cables or conduit up to 1 1/4" (32) dia. and a third reduced size grommet hole for telephone and/or computer cables.
- Rotating cover plate can be positioned for 1, 2, 3 or no cable openings and can be secured in place.
- Architecturally appealing face design compliments contemporary decor.
- Rugged trim ring design secures carpet and prevents edges from fraying.
- Unique adjustable mounting clamp design adapts to any floor thickness and provides simple and secure installation. Permits installation from above the floor without removal of the floor panel or carpet.
- Optional underfloor mounting ring available.
- Standard finish is GR Gray or BK Black core and trim ring. Other finishes are available.

FLOOR "SWIRL" DIFFUSERS

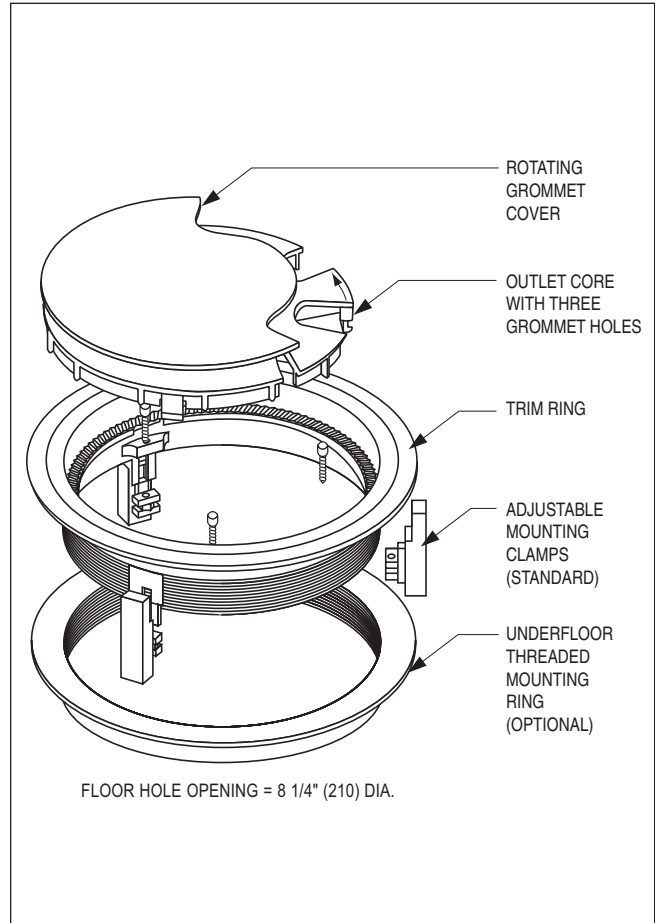

HOW TO SPECIFY OR TO ORDER

(Show complete Model Number and Size, unless "Default" is desired).

Floor Access Outlet – Model NFA

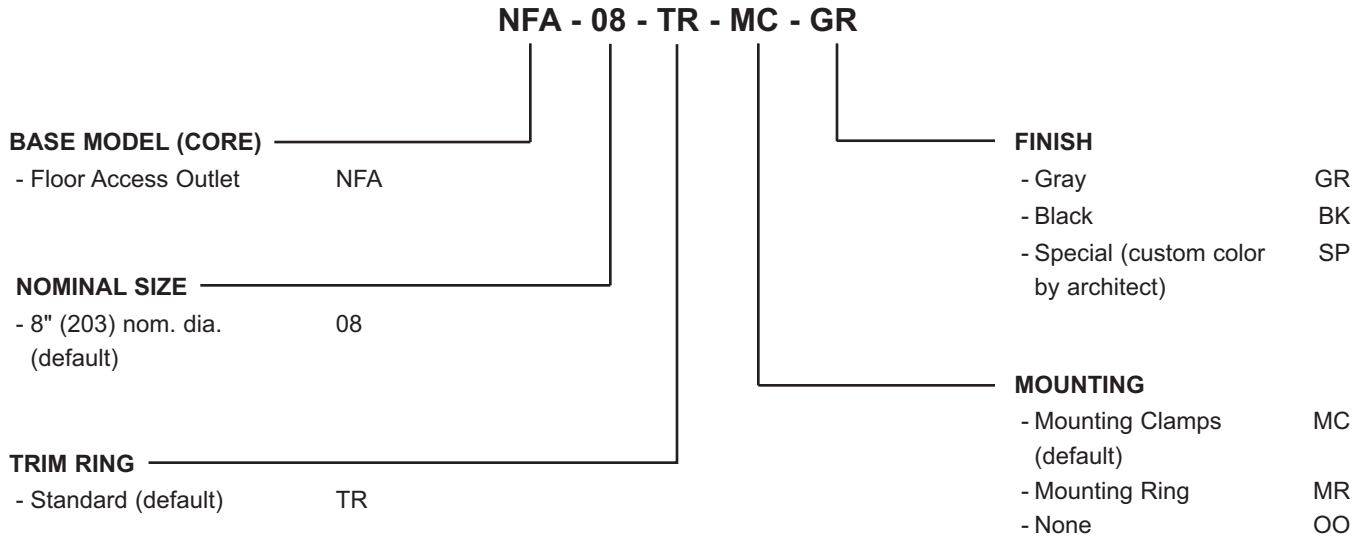

Notes:

Model NFA: Floor Access Outlet

1. Must be ordered with TR Trim Ring.

Example: NFA - 08 - TR - MC - GR

SUGGESTED SPECIFICATION:

Furnish and install **Nailor Model NFA Floor Access Outlets** of the size and type shown on the plans and air distribution schedules. The access outlets shall be constructed entirely of high impact polycarbonate plastic which complies with UL Standard 94-5V for flammability. The design shall incorporate three grommet holes. Two holes shall be large enough to accommodate up to 1 1/4" (32) dia. cables or conduit and a third reduced size grommet hole for telephone and/or computer cables. The outlet shall incorporate a rotating cover plate that can be positioned, and secured in place, for 1, 2, 3 or no cable openings. Three universally adjustable mounting clamps shall be provided for each diffuser to permit installation from above the floor without removal of the floor panel or carpet.

Finish on visible surfaces shall be (GR Gray or BK Black) (other finishes are available).

B

FLOOR "SWIRL" DIFFUSERS

VAV FLOOR "SWIRL" DIFFUSER WITH ACTUATOR

- VARIABLE AIR VOLUME
- ROUND, FLOOR MOUNTED
- HIGH PERFORMANCE
- POLYCARBONATE PLASTIC

Model:
NFD-VAV

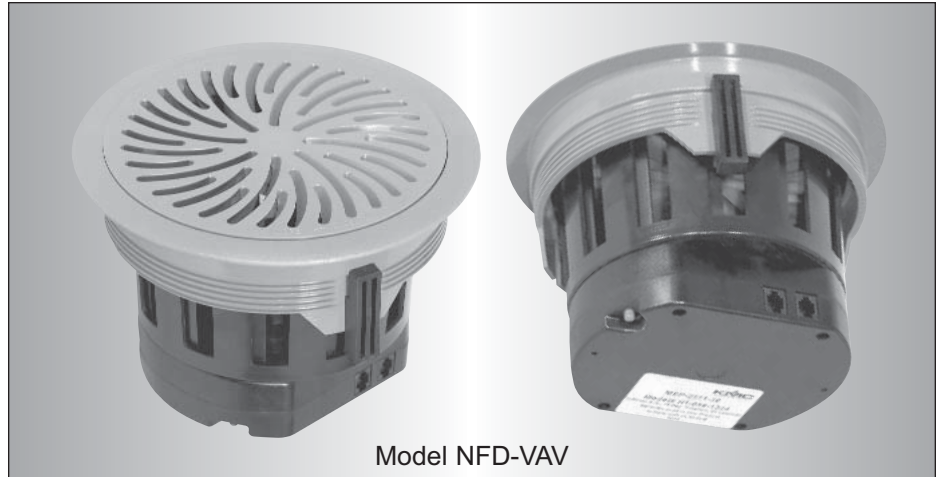

Model NFD-VAV

The **Nailor Model NFD-VAV Floor "Swirl" Diffusers with Actuators** are designed for use in raised access floor air distribution systems, where the floor cavity is used as a pressurized supply air plenum. An integral modulating actuator provides variable air volume control in cooling applications for precise zone temperature control. The NFD-VAV core design produces a low velocity helical "swirl" discharge air pattern. This design achieves high induction rates of room air, which optimizes mixing for maximum comfort conditions.

An architecturally appealing face design compliments any contemporary decor and is available as standard in a gray or black finish as well as a wide variety of custom colors.

Allowing extreme flexibility in space planning, the diffuser, once installed in the access floor panel, can be quickly relocated to accommodate changing conditions and floor layouts. **Performance Data – Refer to pages B5 and B6.**

FEATURES:

- Constructed of high impact, polycarbonate plastic which complies with UL Standard 94-5V for flammability.
- Nominal size 8" (203) dia. Low profile design.
- Variable volume flow regulator damper, features visual open/closed indication and includes built-in end stops.
- Compact 24 VAC direct drive proportional actuator.
- Min. and max. airflow limits are achieved by limiting the range of the control signal.
- Actuator features two RJ12 ports for simple interconnection using modular plenum rated cables. Multiple units can be 'daisy-chained' together.
- Standard 12 ft. modular plenum rated cables, for

interconnection between diffusers, allows diffusers to be spaced on 10 ft. intervals (20 ft. cables optional).

- Optional thermostat, thermostat cable and power supply modules are available.
- Rugged trim ring design secures carpet and prevents edges from fraying.
- Unique adjustable mounting clamp design adapts to any floor thickness and provides simple and secure installation. Permits installation from above the floor without removal of the floor panel or carpet.
- Optional underfloor mounting ring available.
- Standard finish is GR Gray or BK Black core and trim ring. Damper and basket are black. Other finishes are available.

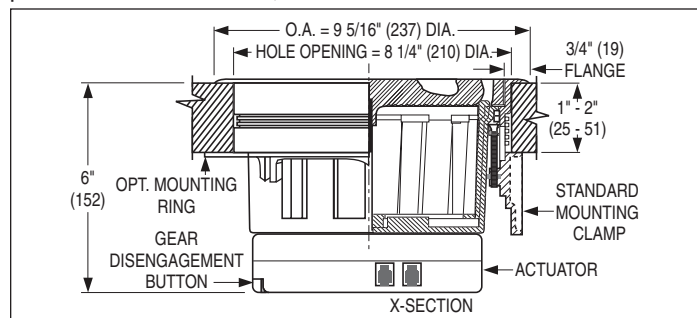
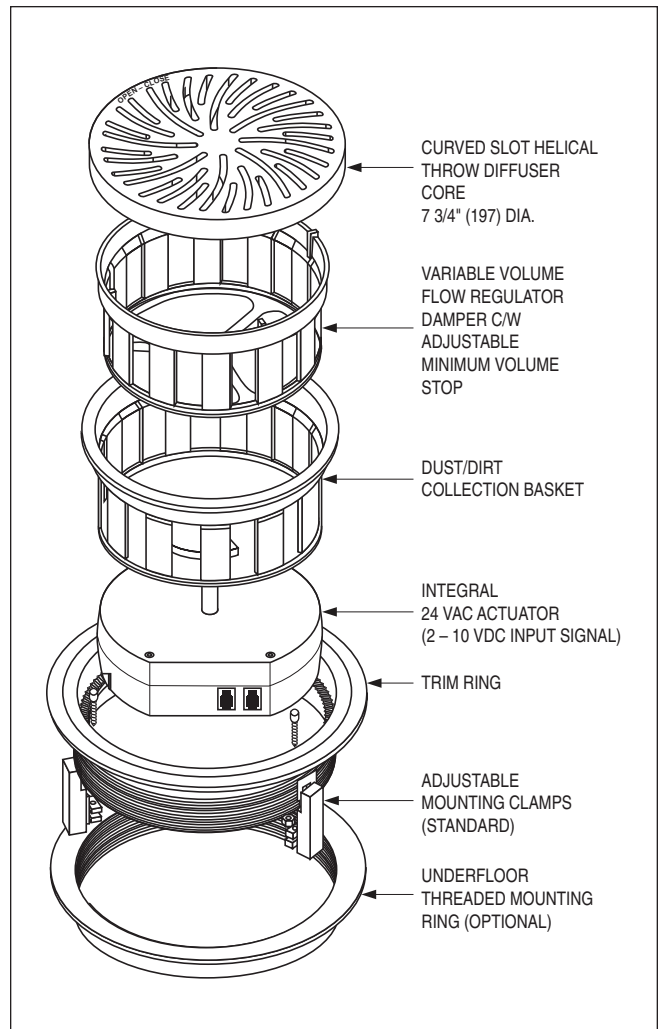

Control Diagram

Model NFD-VAV • Floor "Swirl" Diffuser

DESCRIPTION:

The Nailor NFD-VAV floor diffuser is designed to provide VAV control in cooling applications. Advanced micro-computer electronics and P+I control algorithms provide precise temperature control.

CONTROL FEATURES:

- Fast connection/wiring between units with RJ12 (phone jack) connections. Allows units to be quickly installed or relocated.
- Compact direct-drive 24 VAC actuator utilizes a 2 – 10 VDC control signal for precise airflow control.
- Standard 12 ft. modular plenum rated cables, for interconnection between diffusers, allows diffusers to be spaced on 10 ft. intervals (20 ft. cables optional).
- Power supply modules allow connection of up to 12 units on each line voltage connection (6 diffusers on each side) (8 units total or 4 on each side with optional 20 ft. cables).
- Each thermostat can control a maximum of 3 power supplies.
- Minimum and maximum airflow limits are adjusted underneath the thermostat cover.

ACCESSORIES:

- NCTE-5015-10 °F Scale Thermostat or NCTE-5015-11 °C Scale Thermostat.
- NHSO-5012 50 ft. Thermostat Cable.
- Power Supply Module (includes NHSO-5011 transformer cable, NHSO-5010 3-way connector and transformer mounted & wired in a sheet metal enclosure):
NPS-120 120 Volt Supply Voltage, NPS-277 277 Volt Supply Voltage, NPS-240 240 Volt Supply Voltage or NPS-480 480 Volt Supply Voltage.

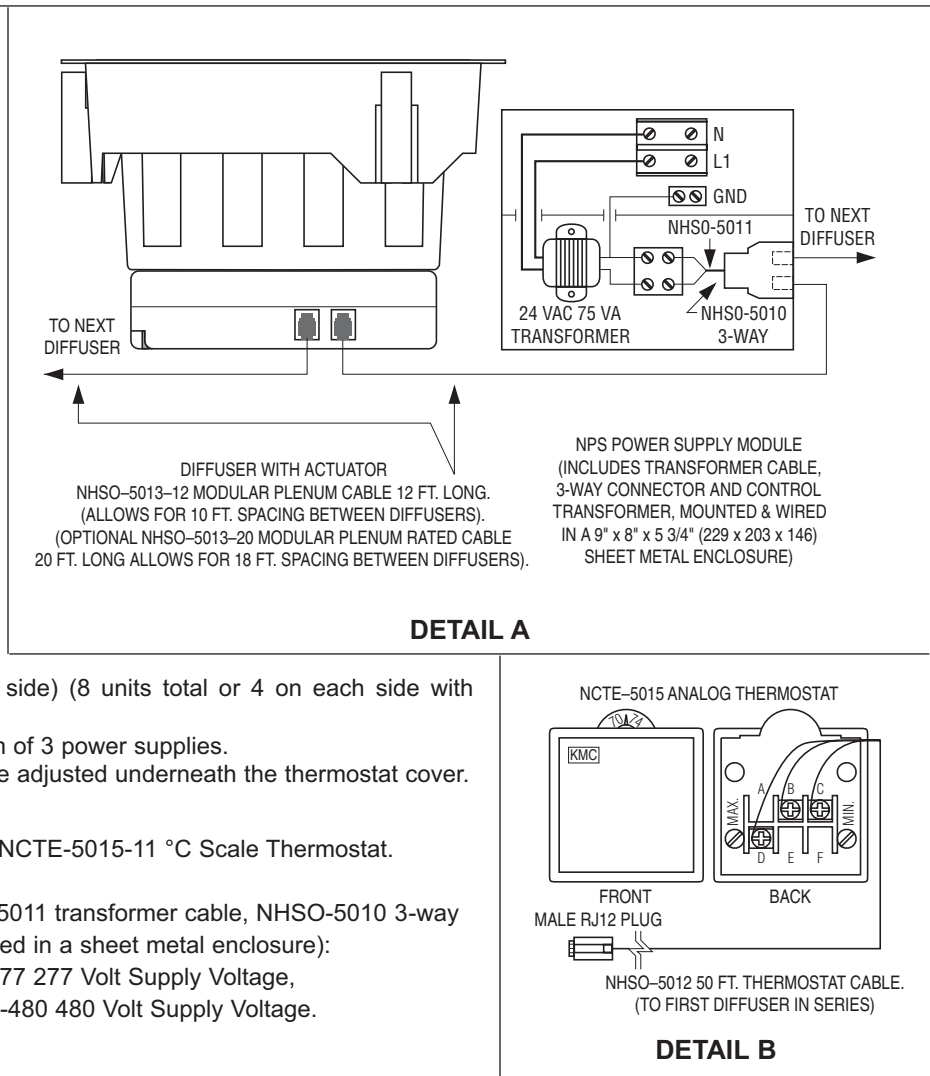

FLOOR "SWIRL" DIFFUSERS

SYSTEM OVERVIEW (SIDE VIEW):

A maximum of six actuators can be daisy chained on each side of a power supply module (4 actuators with optional 20 ft. cables). This allows a maximum of twelve actuators per power supply (8 actuators total with optional 20 ft. cables). Each thermostat can handle up to three power supply/actuator sub-systems for a total of up to thirty-six diffusers per thermostat, (24 diffusers with optional 20 ft. cables).

CONNECTION TO DDC CONTROLS:

The standard thermostat provides a direct acting 2 – 10 VDC control signal (Terminal D) to the actuator (Terminal B is Common). These wires can be connected to another signal source for control by the BMS. A 10 VDC signal will drive the damper fully open to provide maximum airflow. Similarly a 2 VDC signal (or less) will drive the damper fully closed.

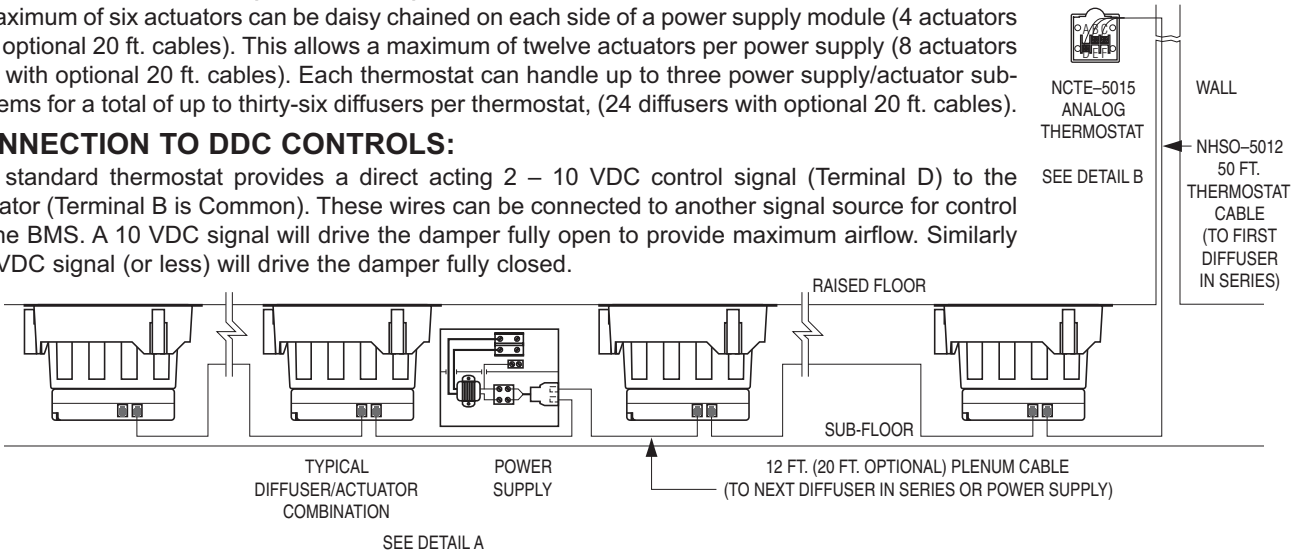

HOW TO SPECIFY OR TO ORDER

(Show complete Model Number and Size, unless "Default" is desired).

VAV Floor "Swirl" Diffuser – Model NFD-VAV

NFD-VAV - 08 - MC - 12 - GR

BASE MODEL

- VAV Floor Diffuser NFD-VAV

NOMINAL SIZE

- 8" (203) nom. dia. 08
(default)

FINISH

- Gray GR
- Black BK
- Special (custom color by architect) SP

ACTUATOR CABLE

- 12 ft. long (default) 12
- 20 ft. long 20

MOUNTING

- Mounting Clamps (default) MC
- Mounting Ring MR

Note:

1. Thermostats, thermostat cable and power supplies have individual model numbers (see previous page).

SUGGESTED SPECIFICATION:

Furnish and install **Nailor Model NFD-VAV Floor "Swirl" Diffusers with Actuators** of the size and type shown on the plans and air distribution schedules. Units shall be complete with all connecting cables and power supply modules as shown. The diffusers shall be constructed entirely of high impact polycarbonate plastic which complies with UL Standard 94-5V for flammability. The core design shall produce a low velocity helical "swirl" discharge air pattern maximizing induction and comfort in the occupied zone. A variable volume flow regulator damper shall be provided with an integral 24 VAC direct drive actuator which operates from a 2 – 10 VDC control signal for precise airflow control. The actuator shall incorporate two RJ12 ports for simple interconnection using modular plenum rated cables and allowing multiple units to be daisy chained together. Each diffuser shall include a standard 12 ft. (20 ft. optional) modular plenum rated cable, for interconnection between diffusers, allowing diffusers to be spaced on 10 ft. (18 ft. optional) intervals. The damper shall have visual open/closed indication and include an adjustable minimum volume stop. The diffusers shall incorporate a removable dust/dirt collection basket to catch anything that might fall through the diffuser face. Three universally adjustable mounting clamps shall be provided for each diffuser to permit installation from above the floor without removal of the floor panel or carpet.

Finish on visible surfaces shall be (GR Gray or BK Black) (other finishes are available).

Power supply modules shall be provided for each diffuser system as shown on the plans and air distribution schedules. Modules shall include a 120 volt control transformer (277, 240 or 460 volt optional) mounted and wired in a protective control enclosure. All electrical components shall be ETL or UL listed or recognized and installed in accordance with the National Electrical Code. The entire assembly shall be ETL listed and so labeled.

Each diffuser system shall be complete with a 50 ft. plenum rated cable for connection to a thermostat or to the DDC/BMS system as provided by others.

(Optional) Each zone shall be complete with an analog 2 – 10 VDC thermostat as shown on the plans. Thermostats shall incorporate advanced micro-computer electronics that include P+I control algorithms for precise temperature control. Thermostat shall have temperature setpoint adjustment in degrees Fahrenheit (Celsius optional) and include a light almond (ash white optional) setpoint cover.

The manufacturer shall provide published performance data for the diffuser, which shall be tested in accordance with ANSI/ASHRAE Standard 70 – 1991.

VAV FLOOR "SWIRL" DIFFUSER WITH ACTUATOR

- VARIABLE AIR VOLUME
- ALUMINUM
- ROUND, FLOOR MOUNTED
- HIGH PERFORMANCE

Model:

ANFD-VAV



NAILOR INDUSTRIES INC.
FLOOR DIFFUSER
"AS TO HEAT RELEASE RATE AND SMOKE
OPTICAL DENSITY ONLY"
R21545 25KU

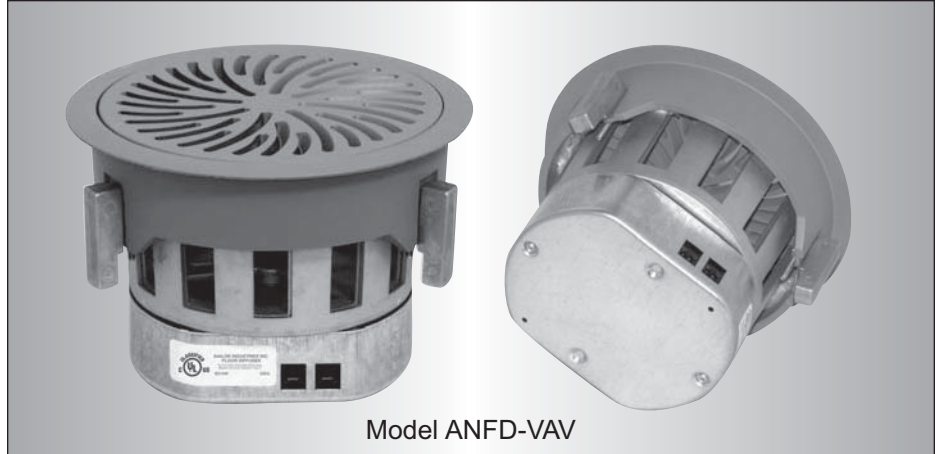

Model ANFD-VAV

The **Nailor Model ANFD-VAV Floor "Swirl" Diffusers with Actuators** are designed for use in raised access floor air distribution systems, where the floor cavity is used as a pressurized supply air plenum. An integral modulating actuator provides variable air volume control in cooling applications for precise zone temperature control. The ANFD-VAV core design produces a low velocity helical "swirl" discharge air pattern. This design achieves high induction rates of room air, which optimizes mixing for maximum comfort conditions.

An architecturally appealing face design compliments any contemporary decor and is available as standard in a gray or black textured finish as well as a wide variety of custom colors.

Allowing extreme flexibility in space planning, the diffuser, once installed in the access floor panel, can be quickly relocated to accommodate changing conditions and floor layouts. **Performance Data – Refer to pages B9 and B10.**

FEATURES:

- Meets all the requirements of NFPA 90A
- Complete assembly is UL tested and classified in accordance with UL Standard 2043.
- Diffuser and components constructed of cast aluminum.
- Nominal size 8" (203) dia. Low profile design.
- Variable volume flow regulator damper, features visual open/closed indication and includes built-in end stops.
- Compact 24 VAC direct drive proportional actuator c/w cover.
- Min. and max. airflow limits are achieved by limiting the range of the control signal.
- Actuator features two RJ12 ports for simple interconnection using modular plenum rated cables. Multiple units can be

'daisy-chained' together.

- Standard 12 ft. modular plenum rated cables, for interconnection between diffusers, allows diffusers to be spaced on 10 ft. intervals (20 ft. cables optional).
- Optional thermostat, thermostat cable and power supply modules are available.
- Rugged trim ring design secures carpet and prevents edges from fraying.
- Unique adjustable mounting clamp design adapts to any floor thickness and provides simple and secure installation. Permits installation from above the floor without removal of the floor panel or carpet.
- Standard finish is GRT Gray or BKT Black textured baked enamel. Other finishes are available.

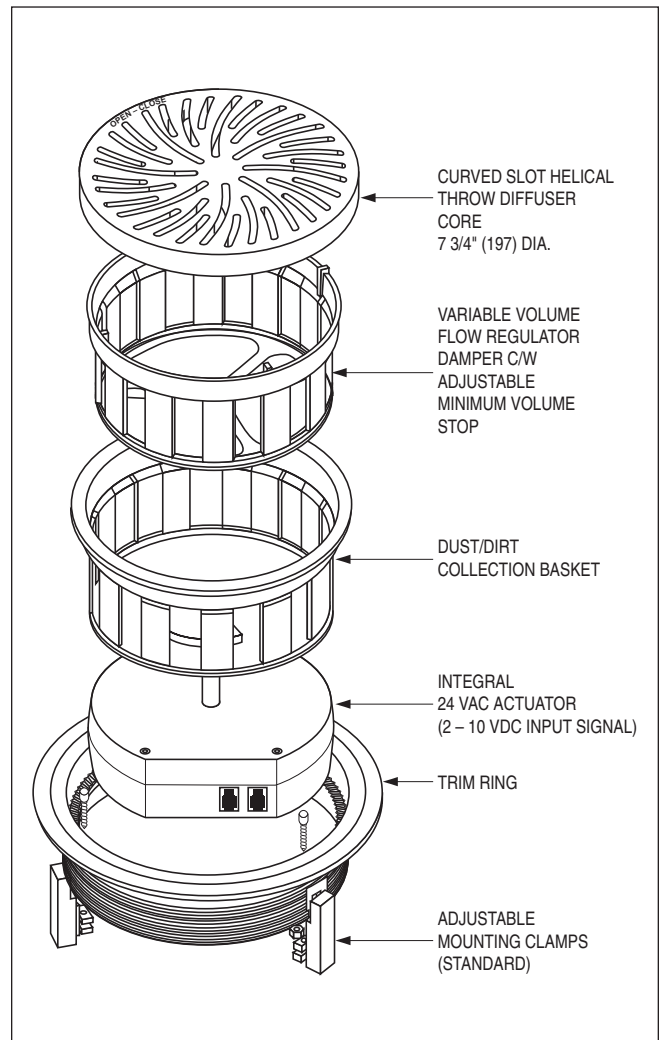
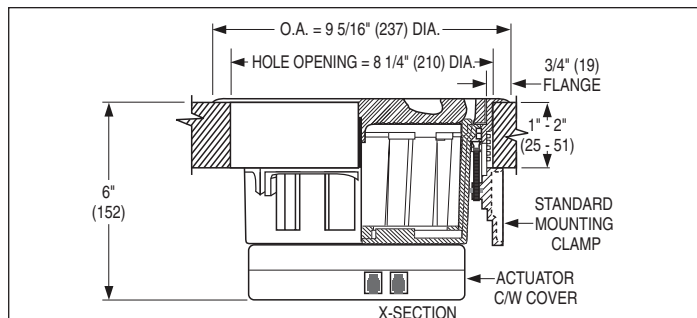

Control Diagram

Model ANFD-VAV • Floor "Swirl" Diffuser

B FLOOR "SWIRL" DIFFUSERS

DESCRIPTION:

The Nailor ANFD-VAV aluminum floor diffuser is designed to provide VAV control in cooling applications. Advanced micro-computer electronics and P+I control algorithms provide precise temperature control.

CONTROL FEATURES:

- Fast connection/wiring between units with RJ12 (phone jack) connections. Allows units to be quickly installed or relocated.
- Compact direct-drive 24 VAC actuator utilizes a 2 – 10 VDC control signal for precise airflow control.
- Standard 12 ft. modular plenum rated cables, for interconnection between diffusers, allows diffusers to be spaced on 10 ft. intervals (20 ft. cables optional).
- Power supply modules allow connection of up to 12 units on each line voltage connection (6 diffusers on each side) (8 units total or 4 on each side with optional 20 ft. cables).
- Each thermostat can control a maximum of 3 power supplies.
- Minimum and maximum airflow limits are adjusted underneath the thermostat cover.

ACCESSORIES:

- NCTE-5015-10 °F Scale Thermostat or NCTE-5015-11 °C Scale Thermostat.
- NHSO-5012 50 ft. Thermostat Cable.
- Power Supply Module (includes NHSO-5011 transformer cable, NHSO-5010 3-way connector and transformer mounted & wired in a sheet metal enclosure):
NPS-120 120 Volt Supply Voltage, NPS-277 277 Volt Supply Voltage, NPS-240 240 Volt Supply Voltage or NPS-480 480 Volt Supply Voltage.

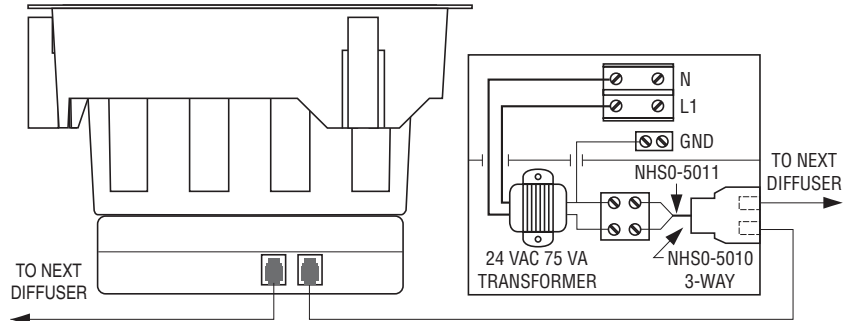

DIFFUSER WITH ACTUATOR
NHSO-5013-12 MODULAR PLENUM CABLE 12 FT. LONG.
(ALLOWS FOR 10 FT. SPACING BETWEEN DIFFUSERS).
(OPTIONAL NHSO-5013-20 MODULAR PLENUM RATED CABLE
20 FT. LONG ALLOWS FOR 18 FT. SPACING BETWEEN DIFFUSERS).

NPS POWER SUPPLY MODULE
(INCLUDES TRANSFORMER CABLE,
3-WAY CONNECTOR AND CONTROL
TRANSFORMER, MOUNTED & WIRED
IN A 9" x 8" x 5 3/4" (229 x 203 x 146)
SHEET METAL ENCLOSURE)

DETAIL A

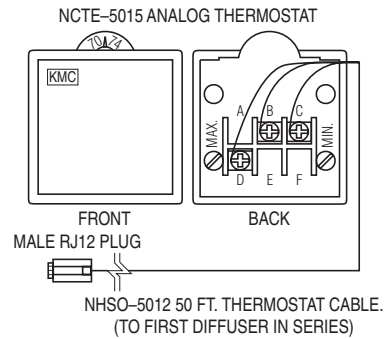

DETAIL B

SYSTEM OVERVIEW (SIDE VIEW):

A maximum of six actuators can be daisy chained on each side of a power supply module (4 actuators with optional 20 ft. cables). This allows a maximum of twelve actuators per power supply (8 actuators total with optional 20 ft. cables). Each thermostat can handle up to three power supply/actuator sub-systems for a total of up to thirty-six diffusers per thermostat, (24 diffusers with optional 20 ft. cables).

CONNECTION TO DDC CONTROLS:

The standard thermostat provides a direct acting 2 – 10 VDC control signal (Terminal D) to the actuator (Terminal B is Common). These wires can be connected to another signal source for control by the BMS. A 10 VDC signal will drive the damper fully open to provide maximum airflow. Similarly a 2 VDC signal (or less) will drive the damper fully closed.

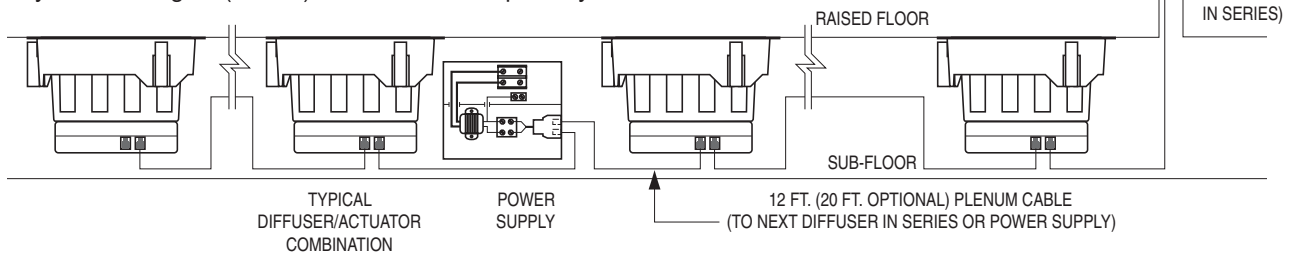

SEE DETAIL A

HOW TO SPECIFY OR TO ORDER

(Show complete Model Number and Size, unless "Default" is desired).

VAV Aluminum Floor "Swirl" Diffuser – Model ANFD-VAV

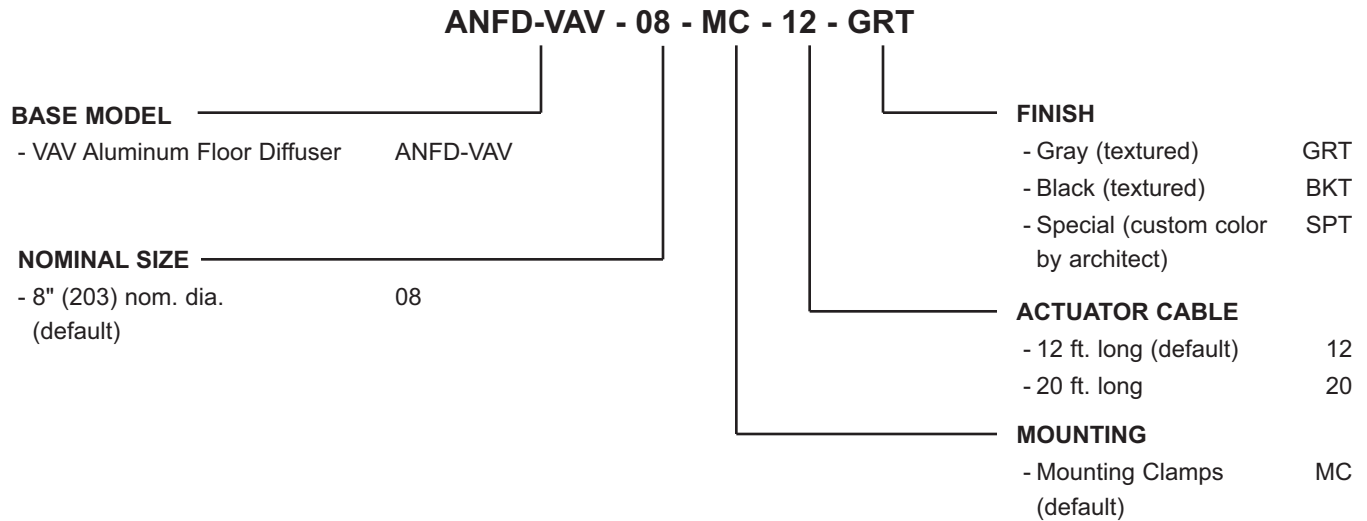

Note:

1. Thermostats, thermostat cable and power supplies have individual model numbers (see previous page).

SUGGESTED SPECIFICATION:

Furnish and install **Nailor Model ANFD-VAV Aluminum Floor "Swirl" Diffusers with Actuators** of the size and type shown on the plans and air distribution schedules. Units shall be complete with all connecting cables and power supply modules as shown. The diffusers shall be constructed entirely of cast aluminum and the actuator shall be mounted within a protective enclosure. The entire assembly shall be tested and classified in accordance with UL Standard 2043. The diffuser shall meet all requirements of NFPA 90A. The core design shall produce a low velocity helical "swirl" discharge air pattern maximizing induction and comfort in the occupied zone. A variable volume flow regulator damper shall be provided with an integral 24 VAC direct drive actuator which operates from a 2 – 10 VDC control signal for precise airflow control. The actuator shall incorporate two RJ12 ports for simple interconnection using modular plenum rated cables and allowing multiple units to be daisy chained together. Each diffuser shall include a standard 12 ft. (20 ft. optional) modular plenum rated cable, for interconnection between diffusers, allowing diffusers to be spaced on 10 ft. (18 ft. optional) intervals. The damper shall have visual open/closed indication and include an adjustable minimum volume stop. The diffusers shall incorporate a removable dust/dirt collection basket to catch anything that might fall through the diffuser face. Three universally adjustable mounting clamps shall be provided for each diffuser to permit installation from above the floor without removal of the floor panel or carpet.

Finish on visible surfaces shall be (GRT Gray or BKT Black) textured baked enamel (other finishes are available).

Power supply modules shall be provided for each diffuser system as shown on the plans and air distribution schedules. Modules shall include a 120 volt control transformer (277, 240 or 460 volt optional) mounted and wired in a protective control enclosure. All electrical components shall be ETL or UL listed or recognized and installed in accordance with the National Electrical Code. The entire assembly shall be ETL listed and so labeled.

Each diffuser system shall be complete with a 50 ft. plenum rated cable for connection to a thermostat or to the DDC/BMS system as provided by others.

(Optional) Each zone shall be complete with an analog 2 – 10 VDC thermostat as shown on the plans. Thermostats shall incorporate advanced micro-computer electronics that include P+I control algorithms for precise temperature control. Thermostat shall have temperature setpoint adjustment in degrees Fahrenheit (Celsius optional) and include a light almond (ash white optional) setpoint cover.

The manufacturer shall provide published performance data for the diffuser, which shall be tested in accordance with ANSI/ASHRAE Standard 70 – 1991.

B
FLOOR "SWIRL" DIFFUSERS

B

FLOOR "SWIRL" DIFFUSERS

PRICES VARY BY QUANTITY
MOORE AIR PRODUCTS CANADA LTD. 1111
1515-20 INDUSTRIAL AVENUE UNIT 100
FOR 1111-394-1111 (TOLL FREE)

MOORE AIR PRODUCTS CANADA LTD.
1111-394-1111 (TOLL FREE)



VAV LINEAR FLOOR DIFFUSERS



Contents

	Page No.
VAV Linear Floor Diffusers	
Rectangular	
NLD-VC - Cooling Only - Non-Ducted - Variable Air Volume	C3
NLD-VH - Heating Only - Non-Ducted - Variable Air Volume	C3
NLD-VCD - Cooling Only - Ducted - Variable Air Volume	C3
NLD-VHD - Heating Only - Ducted - Variable Air Volume	C3
NLD-VCHD - Cooling with Ducted Heating - Variable Air Volume	C3
NLD-VHCD - Heating with Ducted Cooling - Variable Air Volume	C3
NLD - Linear Floor Diffuser Options	C6
NLD - Control Diagram	C7
NLD - Performance Data	C9
Square	
NLYD-VC - Cooling Only - Non-Ducted - Variable Air Volume	C10
NLYD-VH - Heating Only - Non-Ducted - Variable Air Volume	C10
NLYD - Linear Floor Diffuser Options	C12
NLYD - Control Diagram	C13
NLYD - Performance Data	C15

VAV LINEAR FLOOR DIFFUSERS WITH ACTUATOR

- VARIABLE AIR VOLUME
- COOLING AND/OR HEATING
- HEAVY DUTY ALUMINUM GRILLES
- DUCTED OR NON-DUCTED

Models:

NLD-VC

NLD-VH

NLD-VCD

NLD-VHD

NLD-VCHD

NLD-VHCD



NAILOR INDUSTRIES INC.
FLOOR DIFFUSER
"AS TO HEAT RELEASE RATE AND SMOKE
OPTICAL DENSITY ONLY"
R21545 25KU



Model NLD-VHD

The **Nailor Model Series NLD VAV Linear Floor Diffusers with Actuators** are designed for use in raised access floor air distribution systems. High quality, heavy duty, extruded aluminum linear grilles are featured providing an architecturally appealing face design that complements contemporary decor. Heavy gauge steel plenums incorporate a large dust/dirt collection area that catches anything that might fall through the diffuser face.

Model Series NLD provides variable air volume cooling and/or heating control for ducted and/or non-ducted applications. A 90° rotation low leakage damper and integral modulating actuator provide precise airflow control.

FEATURES:

- Meets all the requirements of NFPA 90A.
- Complete assembly including actuator is UL tested and classified in accordance with UL Standard 2043.
- Simple installation, unit fits into place from the top (room side) of the floor panel.
- 12" (305) overall height allows installation in 12" (305) raised access floors.
- Five available heavy duty core styles to choose from.
- All heavy duty cores are removable and supplied with core clips as standard.
- Two available frame options (Frame F or H).
- Standard fastening is Type B friction spring clips.
- Compact 24 VAC direct drive proportional actuator c/w cover.

- Minimum and maximum airflow limits are achieved by limiting the range of the control signal.
- Actuator features two RJ12 ports for simple interconnection using modular plenum rated cables. Multiple units can be 'daisy-chained' together.
- Standard 12 ft. modular plenum rated cables, for interconnection between diffusers, allows diffusers to be spaced on 10 ft. intervals (20 ft. cable optional).
- Standard finish is AW Appliance White.
- Optional finishes include GRT Gray or BKT Black (textured), AL Aluminum, BK Black enamel, SA Satin (clear) Anodized, BC Brushed Clear Coat Lacquer and MI Mill finish. Other finishes are also available.

OPTIONS:

- Thermostat, thermostat cable and power supply modules are available (see following pages).
- Type DV directional vanes provide an adjustable discharge pattern to enhance coverage of perimeter windows and reduce throw.
- BKP black painted finish on interior plenum surfaces.
- BDD backdraft damper is available on Models NLD-VCHD and NLD-VHCD.

Dimensional Data

Model Series NLD • VAV Linear Floor Diffusers • Heating or Cooling Only

Model NLD-VC - VAV - Cooling Only - Non-ducted

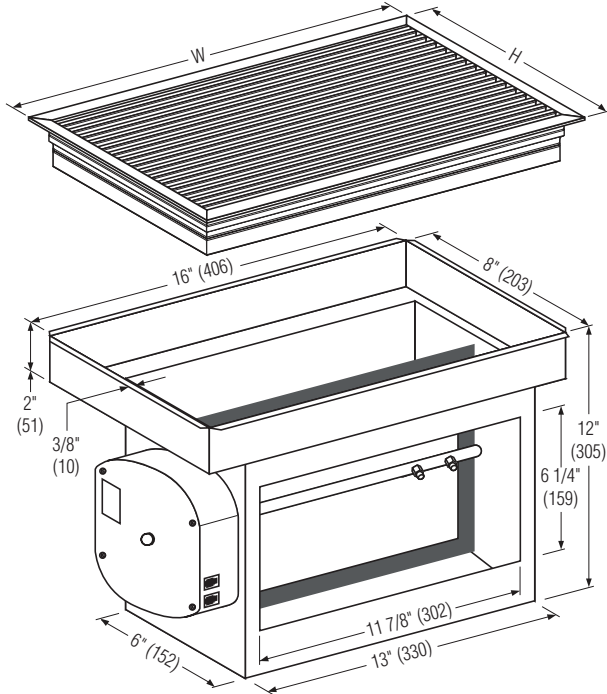

FLOOR OPENING = 16 1/4" x 8 1/4" (413 x 210)
 W = 17 5/8" (448) FOR FRAME F OR 17 1/8" (435) FOR FRAME H
 H = 9 5/8" (244) FOR FRAME F OR 9 1/8" (232) FOR FRAME H

Model NLD-VCD - VAV - Cooling Only - Ducted

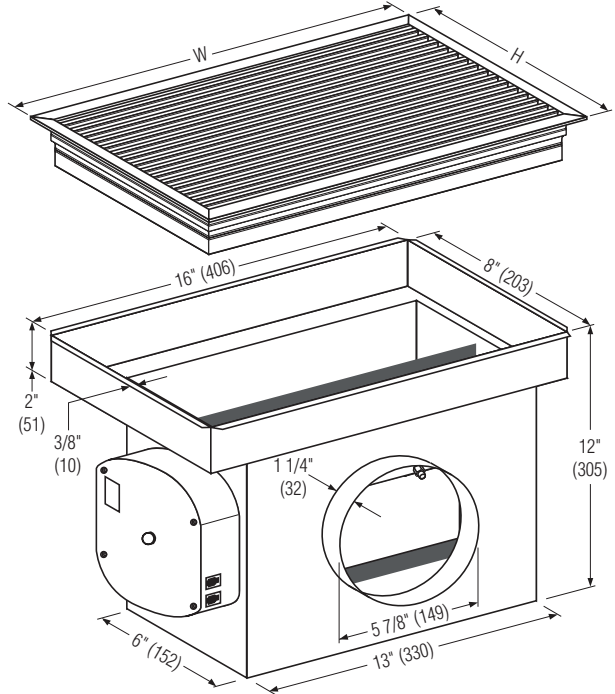

FLOOR OPENING = 16 1/4" x 8 1/4" (413 x 210)
 W = 17 5/8" (448) FOR FRAME F OR 17 1/8" (435) FOR FRAME H
 H = 9 5/8" (244) FOR FRAME F OR 9 1/8" (232) FOR FRAME H

Model NLD-VH - VAV - Heating Only - Non-ducted

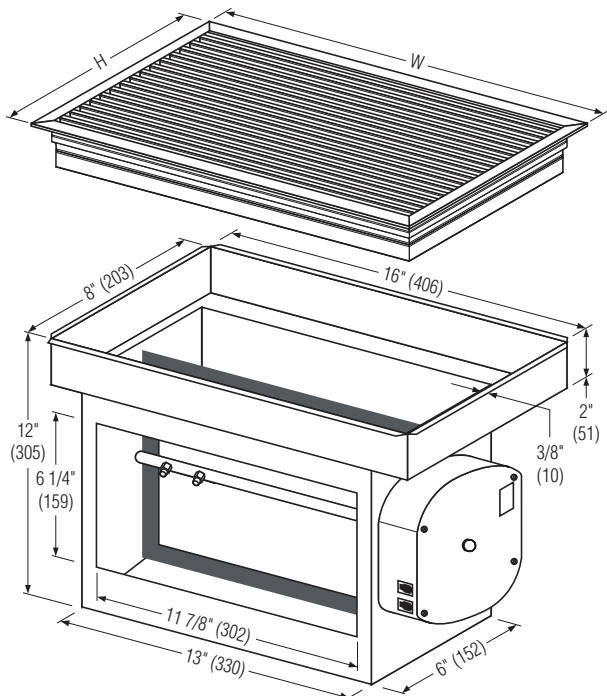

FLOOR OPENING = 16 1/4" x 8 1/4" (413 x 210)
 W = 17 5/8" (448) FOR FRAME F OR 17 1/8" (435) FOR FRAME H
 H = 9 5/8" (244) FOR FRAME F OR 9 1/8" (232) FOR FRAME H

Model NLD-VHD - VAV - Heating Only - Ducted

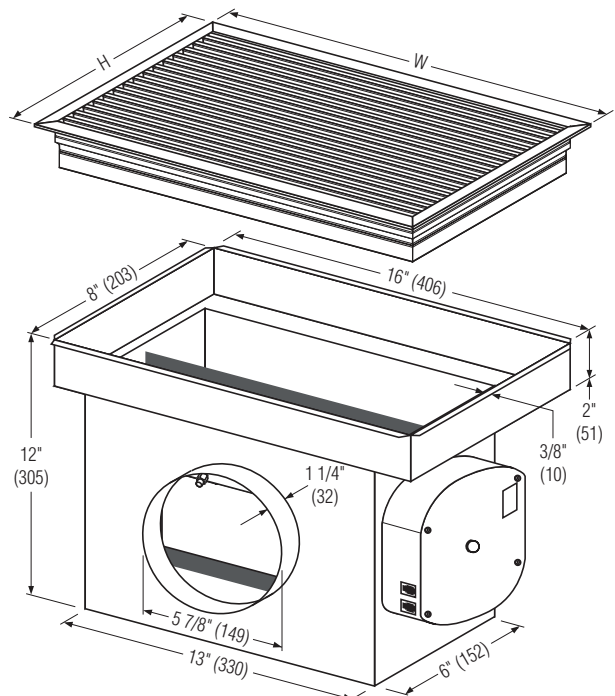

FLOOR OPENING = 16 1/4" x 8 1/4" (413 x 210)
 W = 17 5/8" (448) FOR FRAME F OR 17 1/8" (435) FOR FRAME H
 H = 9 5/8" (244) FOR FRAME F OR 9 1/8" (232) FOR FRAME H

Dimensional Data

Model Series NLD • VAV Linear Floor Diffusers • Heating and Cooling

Model NLD-VHCD - VAV - Heating with Ducted Cooling

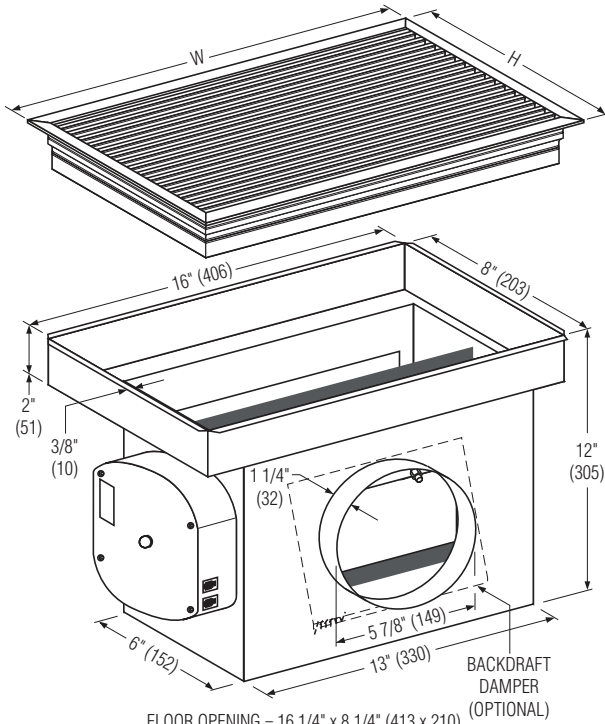

FLOOR OPENING = 16 1/4" x 8 1/4" (413 x 210)
 W = 17 5/8" (448) FOR FRAME F OR 17 1/8" (435) FOR FRAME H
 H = 9 5/8" (244) FOR FRAME F OR 9 1/8" (232) FOR FRAME H

Model NLD-VCHD - VAV - Cooling with Ducted Heating

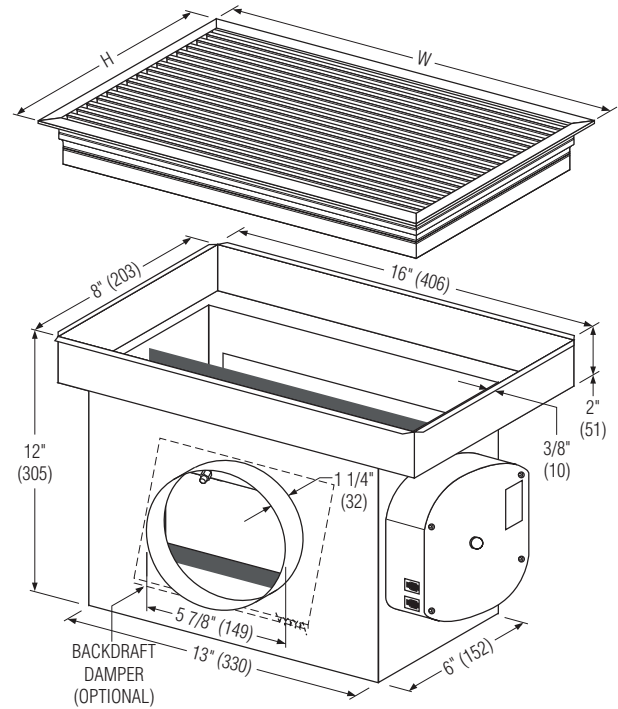

FLOOR OPENING = 16 1/4" x 8 1/4" (413 x 210)
 W = 17 5/8" (448) FOR FRAME F OR 17 1/8" (435) FOR FRAME H
 H = 9 5/8" (244) FOR FRAME F OR 9 1/8" (232) FOR FRAME H



Model Series NLD

Selection Options

Model Series NLD • VAV Linear Floor Diffusers

Available Core Styles

- 480** (standard) - 1/4" (6) Spacing
 - 1/8" (3) Bars
 - 0° Deflection (Standard)

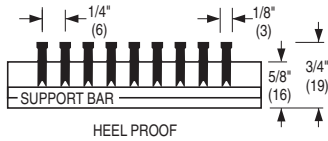

- 481** - 1/4" (6) Spacing
 - 1/8" (3) Bars
 - 15° Deflection

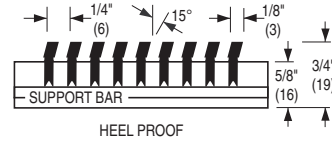

- 240** - 1/2" (13) Spacing
 - 1/4" (6) Bars
 - 0° Deflection

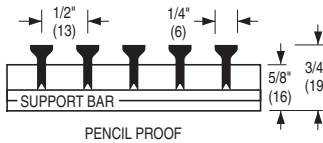

- 241** - 1/2" (13) Spacing
 - 1/4" (6) Bars
 - 15° Deflection

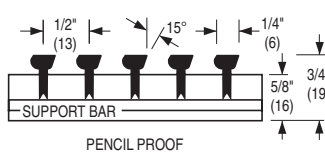

- 243** - 1/2" (13) Spacing
 - 1/4" (6) Bars
 - 30° Deflection

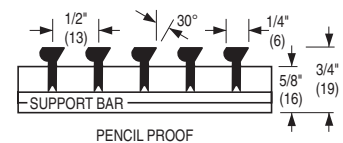

Frame Type

- F** (Standard)
 1" (25) Border Flange

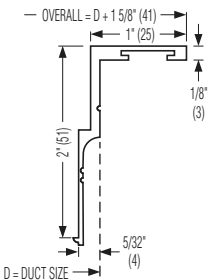

- H** (Optional)
 3/4" (19) Beveled Border Flange

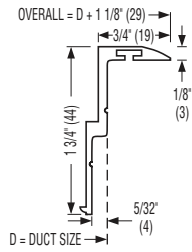

Fastening

- B** (Standard)
 Spring Clip (Frames F or H)

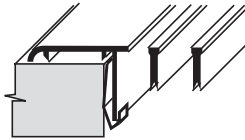

- A** (Optional)
 #8 Countersunk Screw Holes (Frame F only)

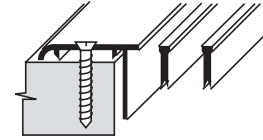

Actuator Cable Length

- 12** 12 ft. long (Standard)
20 20 ft. long

Available Finishes

- | | |
|--------------------------------------|--------------------------------------|
| AW Appliance White (Standard) | SA Satin (clear) Anodized |
| GRT Gray (Textured) | BC Brushed Clear-Coat Lacquer |
| BKT Black (Textured) | MI Mill |
| AL Aluminum | BK Black |
| SP Special _____ | SPT Special (Textured) _____ |

Optional Items

- Type DV** Directional Vanes
 Fully adjustable extruded aluminum blades on 3/4" (19) centers perpendicular to length.

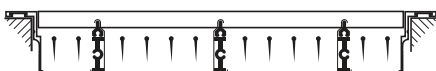

- BDD** Backdraft damper available on models NLD-VCHD and NLD-VHCD.

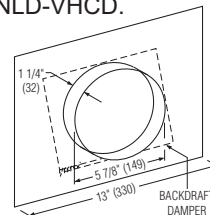

- BKP** Plenum interior painted black.

Control Diagram

Model Series NLD • VAV Linear Floor Diffusers

DESCRIPTION:

The Nailor NLD Series floor diffusers are designed to provide VAV control in cooling and/or heating applications. Advanced micro-computer electronics and P+I control algorithms provide precise temperature control.

CONTROL FEATURES:

- Fast connection/wiring between units with RJ12 (phone jack) connections. Allows units to be quickly installed or relocated.
- Compact direct-drive 24 VAC actuator utilizes a 2 – 10 VDC control signal for precise airflow control.
- Standard 12 ft. modular plenum rated cables, for interconnection between diffusers, allows diffusers to be spaced on 10 ft. intervals (20 ft. cables optional).
- Power supply modules allow connection of up to 12 units on each line voltage connection (6 diffusers on each side) (8 units total or 4 on each side with optional 20 ft. cables).
- Each thermostat can control a maximum of 3 power supplies.
- Minimum and maximum airflow limits are adjusted underneath the thermostat cover.

ACCESSORIES:

- NCTE-5015-10 °F Scale Thermostat or NCTE-5015-11 °C Scale Thermostat.
- NHSO-5012 50 ft. Thermostat Cable
- Power Supply Module (includes NHSO-5011 transformer cable, NHSO-5010 3-way connector and transformer mounted & wired in a sheet metal enclosure):
NPS-120 120 Volt Supply Voltage, NPS-277 277 Volt Supply Voltage, NPS-240 240 Volt Supply Voltage or NPS-480 480 Volt Supply Voltage.

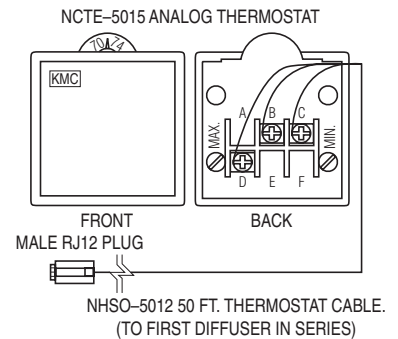
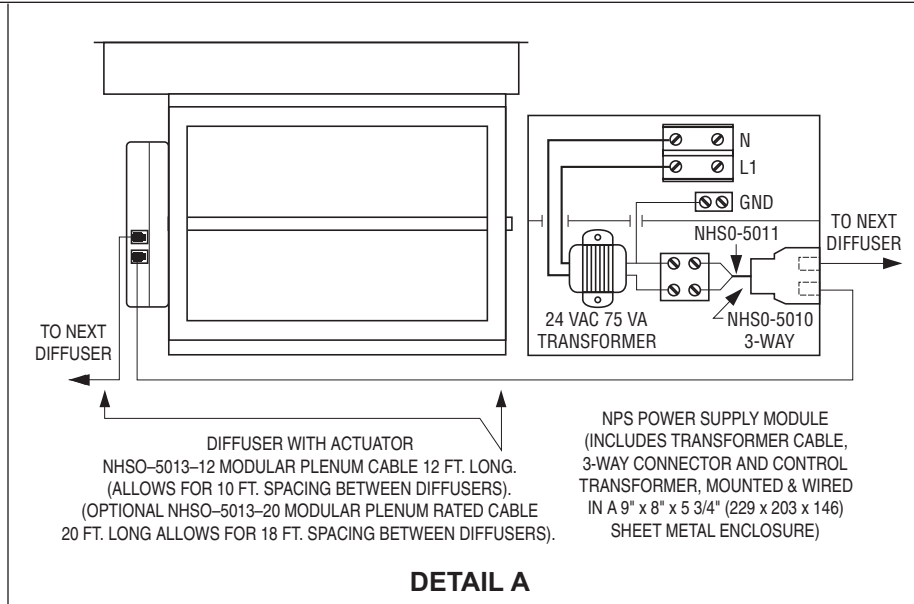

SYSTEM OVERVIEW (SIDE VIEW):

A maximum of six actuators can be daisy chained on each side of a power supply module (4 actuators with optional 20 ft. cables). This allows a maximum of twelve actuators per power supply (8 actuators total with optional 20 ft. cables). Each thermostat can handle up to three power supply/actuator sub-systems for a total of up to thirty-six diffusers per thermostat, (24 diffusers with optional 20 ft. cables).

CONNECTION TO DDC CONTROLS:

The standard thermostat provides a direct acting 2 – 10 VDC control signal (Terminal D) to the actuator (Terminal B is Common). These wires can be connected to another signal source for control by the BMS. For cooling only units a 10 VDC signal will drive the damper fully open to provide maximum airflow. Similarly a 2 VDC signal (or less) will drive the damper fully closed.

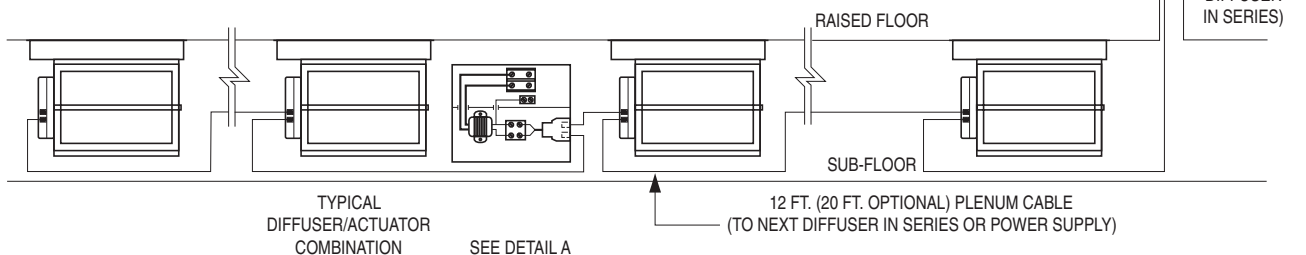

VAV LINEAR FLOOR DIFFUSERS

HOW TO SPECIFY OR TO ORDER

(Show complete Model Number and Size, unless "Default" is desired).

VAV Linear Floor Diffusers with Actuator – Rectangular – Model Series NLD

NLD - VC - 16x8 - 480 - F - B - 12 - AW - DV

BASE MODEL

- VAV Linear Floor Diffuser w/Actuator NLD

PLENUM TYPE

- VAV Cooling Only VC
 - VAV Cooling Only - Ducted VCD
 - VAV Heating Only VH
 - VAV Heating Only - Ducted VHD
 - VAV Cooling with Ducted Heating VCHD
 - VAV Heating with Ducted Cooling VHCD

NOMINAL SIZE

- 16 x 8 (406 x 203) (default)

CORE STYLE

- 1/8" (3) Bars – 1/4" (6) Spacing – 0° Deflection 480 (default)
 - 1/8" (3) Bars – 1/4" (6) Spacing – 15° Deflection 481
 - 1/4" (6) Bars – 1/2" (13) Spacing – 0° Deflection 240
 - 1/4" (6) Bars – 1/2" (13) Spacing – 15° Deflection 241
 - 1/4" (6) Bars – 1/2" (13) Spacing – 30° Deflection 243

FRAME TYPE

- 1" (25) Heavy Duty Flange F (default)
 - 3/4" (19) Bevelled Heavy Duty Flange H

Note:

1. Thermostats, thermostat cable and power supplies have individual model numbers (see previous page).

OPTIONS

- Directional Vanes DV
 - Plenum Interior painted Black BKP
 - Backdraft Damper BDD
 (Models VCHD or VHCD only)

FINISH

- Appliance White (Default) AW
 - Gray (Textured) GRT
 - Black (Textured) BKT
 - Aluminum AL
 - Satin (clear) anodized SA
 - Brushed clear-coat lacquer BC
 - Mill MI
 - Black BK
 - Special custom color (Textured) SPT
 - Special custom color SP

ACTUATOR CABLE

- 12 ft. long (default) 12
 - 20 ft. long 20

FASTENING

- Friction spring clip (default) B
 - Countersunk screw holes (Frame F only) A

SUGGESTED SPECIFICATION:

Furnish and install **Nailor Model NLD VAV Linear Floor Diffusers with Actuators** of the size and type shown on the plans and air distribution schedules. Units shall be complete with all connecting cables and power supply modules as shown. The diffusers shall incorporate heavy duty extruded aluminum linear grilles mounted in a heavy gauge galvanized steel plenum. The actuator shall be mounted within a protective enclosure. The entire assembly shall be tested and classified in accordance with UL Standard 2043. The diffuser shall meet all requirements of NFPA 90A. The plenum shall incorporate a 90 degree rotation low leakage damper and an integral 24 VAC direct drive actuator which operates from a 2 – 10 VDC control signal for precise airflow control. The actuator shall incorporate two RJ12 ports for simple interconnection using modular plenum rated cables and allowing multiple units to be daisy chained together. Each diffuser shall include a standard 12 ft. (20 ft. optional) modular plenum rated cable, for interconnection between diffusers, allowing diffusers to be spaced on 10 ft. (18 ft. optional) intervals. The plenum shall incorporate a dust/dirt collection area to catch anything that might fall through the diffuser face. Finish on visible surfaces shall be AW Appliance White baked enamel (other finishes are available).

Power supply modules shall be provided for each diffuser system as shown on the plans and air distribution schedules. Modules shall include a 120 volt control transformer (277, 240 or 460 volt optional) mounted and wired in a protective control enclosure. All electrical components shall be ETL or UL listed or recognized and installed in accordance with the National Electrical Code. The entire assembly shall be ETL listed and so labeled.

Each diffuser system shall be complete with a 50 ft. plenum rated cable for connection to a thermostat or to the DDC/BMS system as provided by others.

(Optional) Each zone shall be complete with an analog 2 – 10 VDC thermostat as shown on the plans. Thermostats shall incorporate advanced micro-computer electronics that include P+I control algorithms for precise temperature control. Thermostat shall have temperature setpoint adjustment in degrees Fahrenheit (Celsius optional) and include a light almond (ash white optional) setpoint cover.

The manufacturer shall provide published performance data for the diffuser, which shall be tested in accordance with ANSI/ASHRAE Standard 70 – 1991.

Performance Data

Model Series NLD

Airflow, cfm	50	75	100	125	150
NC	-	-	-	-	18
22 Degree Blade Deflection					
Plenum Pressure, in w.g.	0.0045	0.010	0.017	0.024	0.033
Vertical Projection, ft. @ 150, 100, 50 fpm	0-1-2	0.5-2-3	1.5-4.5-5	4-5.5-6.5	6-6.5-8
Horizontal Spread, ft. @ 150, 100, 50 fpm	0-1-1.5	0.5-1.5-2.5	1.5-2.5-5	3-4-7.5	4-5-10
45 Degree Blade Deflection					
Plenum Pressure, in w.g.	0.0045	0.010	0.017	0.025	0.035
Vertical Projection, ft. @ 150, 100, 50 fpm	0-1-2	1-2-3	1-3.5-4.5	3-5-5.5	5-6-6.5
Horizontal Spread, ft. @ 150, 100, 50 fpm	0-1-1.5	0.5-1-4	2.5-4-5	5-6-7	6-7.5-9
60 Degree Blade Deflection					
Plenum Pressure, in w.g.	0.005	0.011	0.018	0.056	0.080
Vertical Projection, ft. @ 150, 100, 50 fpm	0-1-1.5	1.5-2.5-3.5	3-4-5	4-5-5.5	5-5.5-6
Horizontal Spread, ft. @ 150, 100, 50 fpm	0-1-2	0.5-1-4.5	2.5-4-5	4.5-6-8	6.5-8.5-11

Performance Notes:

- Projection and Spread data were determined in a room with an 11' ceiling height and 10°F ΔT, between supply air and averaged occupied room temperature.
- Vertical projection (throw) is the maximum height above the floor where terminal velocities of 150, 100 and 50 fpm were observed. Horizontal Spread is the total width of the isovel where terminal velocities of 150, 100 and 50 fpm were observed.
- Noise Criteria (values) based on 10 dB room absorption, re 10⁻¹² watts. Dash (-) in space denotes an NC value of less than 15.
- Tests conducted on units complete with directional vanes adjusted to the deflection settings of 22, 45 or 60 degrees. Damper fully open.
- Data derived from independent tests conducted in accordance with ANSI/ASHRAE Standard 70 – 1991.

PERFORMANCE TEST – MODEL NLD @ 150 CFM

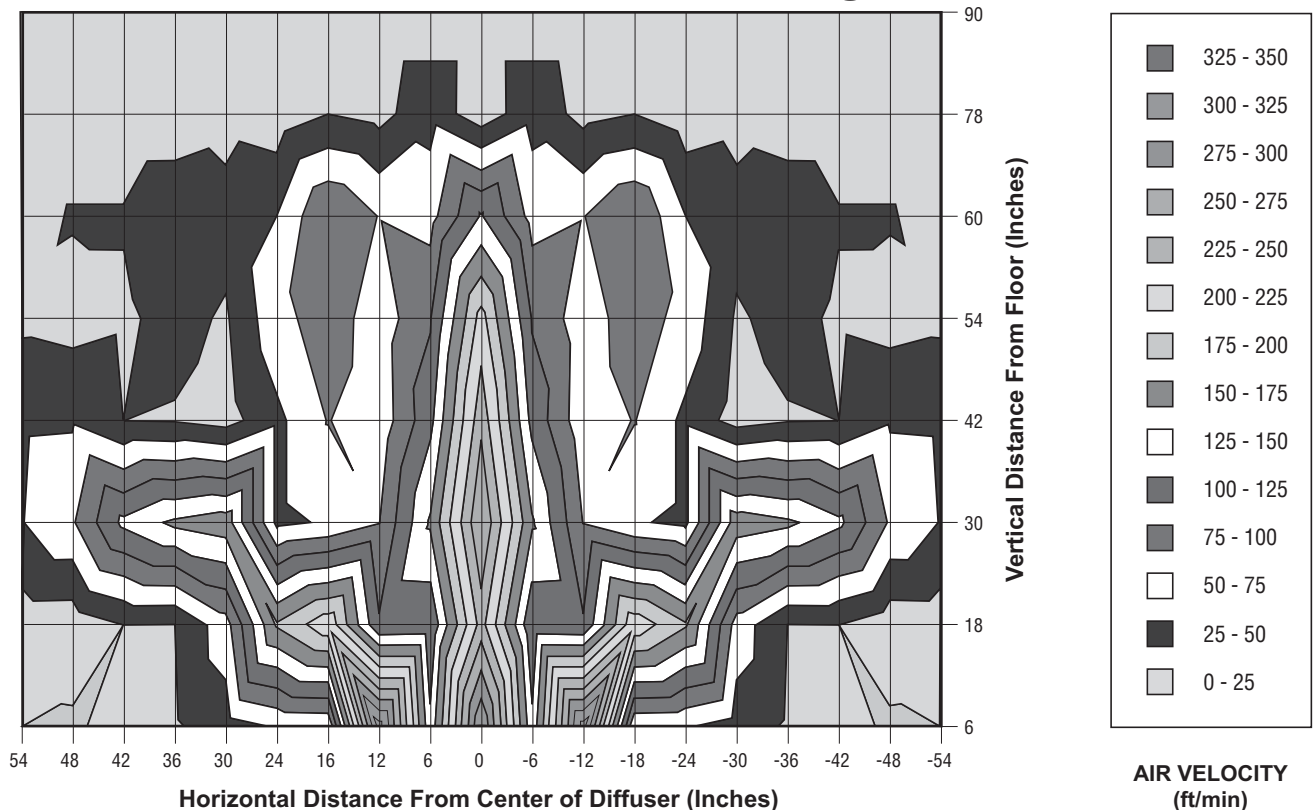

Note: The graph above shows actual air velocities and the associated isovels. This data was obtained in a full scale mock-up test performed on a standard Model NLD @ 150 cfm with a 10°F ΔT and a 45° blade deflection.

VAV LINEAR FLOOR DIFFUSERS WITH ACTUATOR

- VARIABLE AIR VOLUME
- COOLING OR HEATING
- HEAVY DUTY ALUMINUM GRILLES

Models:

NLYD-VC

NLYD-VH



NAILOR INDUSTRIES INC.
FLOOR DIFFUSER
"AS TO HEAT RELEASE RATE AND SMOKE
OPTICAL DENSITY ONLY"
R21545 25KU



Model NLYD-VH

The **Nailor Model Series NLYD VAV Linear Floor Diffusers with Actuators** are designed for use in raised access floor air distribution systems. High quality, heavy duty, extruded aluminum linear grilles are featured providing an architecturally appealing face design that compliments contemporary decor. Heavy gauge steel plenums incorporate a dust/dirt collection area that catches anything that might fall through the diffuser face.

Model Series NLYD provides variable air volume cooling or heating control for non-ducted (pressurized access floor) applications. A 90° rotation low leakage damper and integral modulating actuator provide precise airflow control.

FEATURES:

- Meets all the requirements of NFPA 90A.
- Complete assembly including actuator is UL tested and classified in accordance with UL Standard 2043.
- Simple installation, unit fits into place from the top (room side) of the floor panel.
- 9" (229) overall height allows installation in 9" (229) raised access floors.
- Five available heavy duty core styles to choose from.
- All heavy duty cores are removable and supplied with core clips as standard.
- Two available frame options (Frame F or H).
- Standard fastening is Type B friction spring clips.
- Compact 24 VAC direct drive proportional actuator c/w cover.

- Minimum and maximum airflow limits are achieved by limiting the range of the control signal.
- Actuator features two RJ12 ports for simple interconnection using modular plenum rated cables. Multiple units can be 'daisy-chained' together.
- Standard 12 ft. modular plenum rated cables, for interconnection between diffusers, allows diffusers to be spaced on 10 ft. intervals (20 ft. cable optional).
- Standard finish is AW Appliance White.
- Optional finishes include GRT Gray or BKT Black (textured), AL Aluminum, BK Black enamel, SA Satin (clear) Anodized, BC Brush Clear Coat Lacquer and MI Mill finish. Other finishes are also available.

OPTIONS:

- Thermostat, thermostat cable and power supply modules are available (see following pages).
- Type DV directional vanes provide an adjustable discharge pattern to enhance coverage of perimeter windows and reduce throw.
- BKP black painted finish on interior plenum surfaces.

Dimensional Data

Model Series NLYD • VAV Linear Floor Diffusers • Heating or Cooling Only

Model NLYD-VC - VAV - Cooling Only - Non-ducted

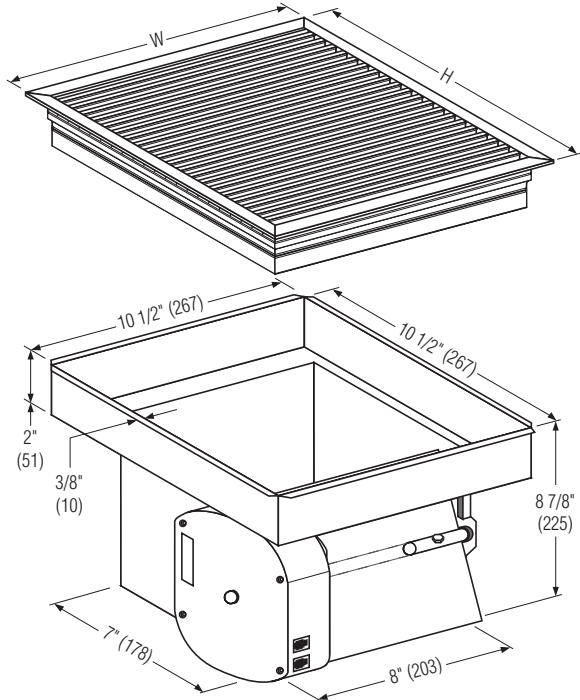

FLOOR OPENING = 10 3/4" x 10 3/4" (273 x 273)
 W OR H = 12 1/8" (308) FOR FRAME F OR 11 5/8" (295) FOR FRAME H

Model NLYD-VH - VAV - Heating Only - Non-ducted

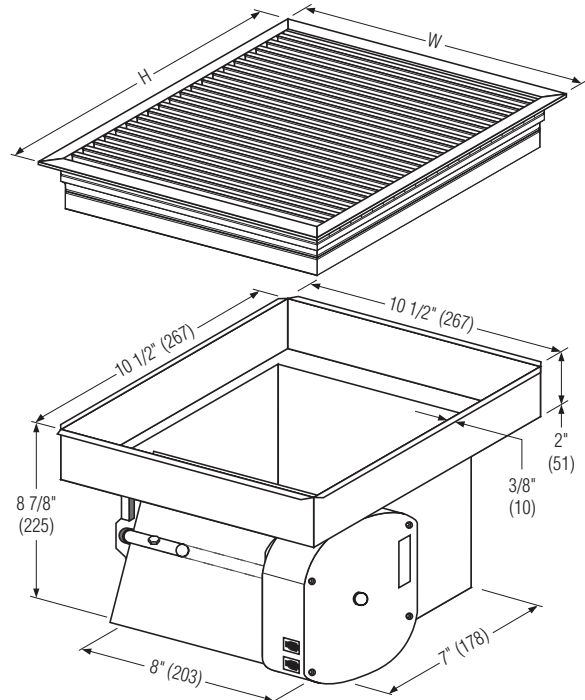

FLOOR OPENING = 10 3/4" x 10 3/4" (273 x 273)
 W OR H = 12 1/8" (308) FOR FRAME F OR 11 5/8" (295) FOR FRAME H

VAV LINEAR FLOOR DIFFUSERS



Model Series NLYD

Selection Options

Model Series NLYD • VAV Linear Floor Diffusers • Selection Options

Available Core Styles

480 (standard) - 1/4" (6) Spacing
 - 1/8" (3) Bars
 - 0° Deflection (Standard)

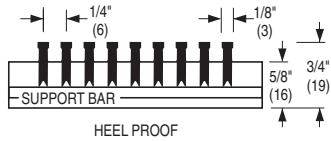

481 - 1/4" (6) Spacing
 - 1/8" (3) Bars
 - 15° Deflection

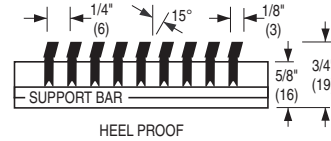

240 - 1/2" (13) Spacing
 - 1/4" (6) Bars
 - 0° Deflection

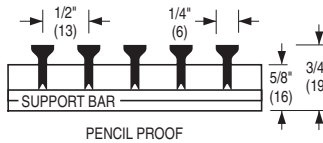

241 - 1/2" (13) Spacing
 - 1/4" (6) Bars
 - 15° Deflection

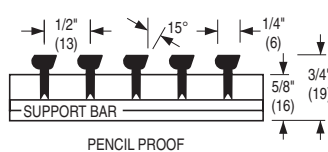

243 - 1/2" (13) Spacing
 - 1/4" (6) Bars
 - 30° Deflection

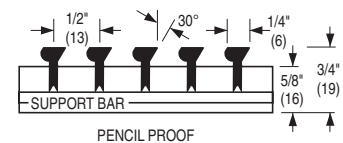

Frame Type

F (Standard)
 1" (25) Border Flange

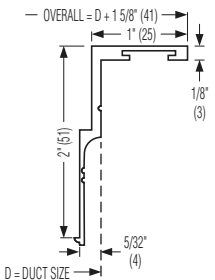

H (Optional)
 3/4" (19) Beveled Border Flange

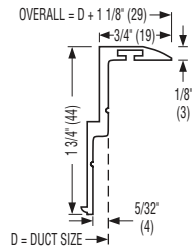

Fastening

B (Standard)
 Spring Clip (Frames F or H)

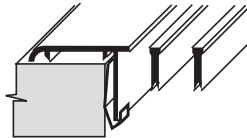

A (Optional)
 #8 Countersunk Screw Holes (Frame F only)

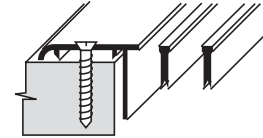

Actuator Cable Length

12 12 ft. long (Standard)
20 20 ft. long

Available Finishes

AW Appliance White (Standard)	SA Satin (clear) Anodized
GRT Gray (Textured)	BC Brushed Clear-Coat Lacquer
BKT Black (Textured)	MI Mill
AL Aluminum	BK Black
SP Special _____	SPT Special (Textured) _____

Optional Items

Type DV Directional Vanes
 Fully adjustable extruded aluminum blades on 3/4" (19) centers perpendicular to length.

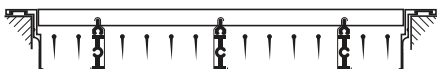

BKP Plenum interior painted black.

Control Diagram

Model Series NLYD • VAV Linear Floor Diffusers

DESCRIPTION:

The Nailor NLYD floor diffuser is designed to provide VAV control in heating or cooling only applications. Advanced micro-computer electronics and P+I control algorithms provide precise temperature control.

CONTROL FEATURES:

- Fast connection/wiring between units with RJ12 (phone jack) connections. Allows units to be quickly installed or relocated.
- Compact direct-drive 24 VAC actuator utilizes a 2 – 10 VDC control signal for precise airflow control.
- Standard 12 ft. modular plenum rated cables, for interconnection between diffusers, allows diffusers to be spaced on 10 ft. intervals (20 ft. cables optional).
- Power supply modules allow connection of up to 12 units on each line voltage connection (6 diffusers on each side) (8 units total or 4 on each side with optional 20 ft. cables).
- Each thermostat can control a maximum of 3 power supplies.
- Minimum and maximum airflow limits are adjusted underneath the thermostat cover.

ACCESSORIES:

- NCTE-5015-10 °F Scale Thermostat or NCTE-5015-11 °C Scale Thermostat.
- NHSO-5012 50 ft. Thermostat Cable.
- Power Supply Module (includes NHSO-5011 transformer cable, NHSO-5010 3-way connector and transformer mounted & wired in a sheet metal enclosure):
NPS-120 120 Volt Supply Voltage, NPS-277 277 Volt Supply Voltage, NPS-240 240 Volt Supply Voltage or NPS-480 480 Volt Supply Voltage.

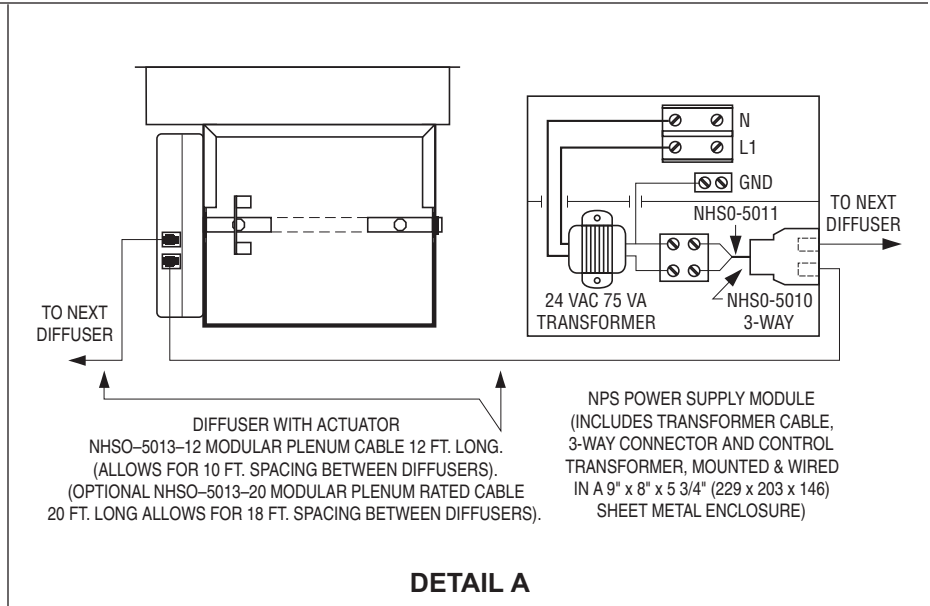

DETAIL A

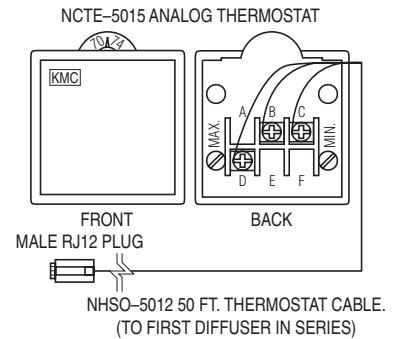

DETAIL B

SYSTEM OVERVIEW (SIDE VIEW):

A maximum of six actuators can be daisy chained on each side of a power supply module (4 actuators with optional 20 ft. cables). This allows a maximum of twelve actuators per power supply (8 actuators total with optional 20 ft. cables). Each thermostat can handle up to three power supply/actuator sub-systems for a total of up to thirty-six diffusers per thermostat, (24 diffusers with optional 20 ft. cables).

CONNECTION TO DDC CONTROLS:

The standard thermostat provides a direct acting 2 – 10 VDC control signal (Terminal D) to the actuator (Terminal B is Common). These wires can be connected to another signal source for control by the BMS. For cooling only units a 10 VDC signal will drive the damper fully open to provide maximum airflow. Similarly a 2 VDC signal (or less) will drive the damper fully closed.

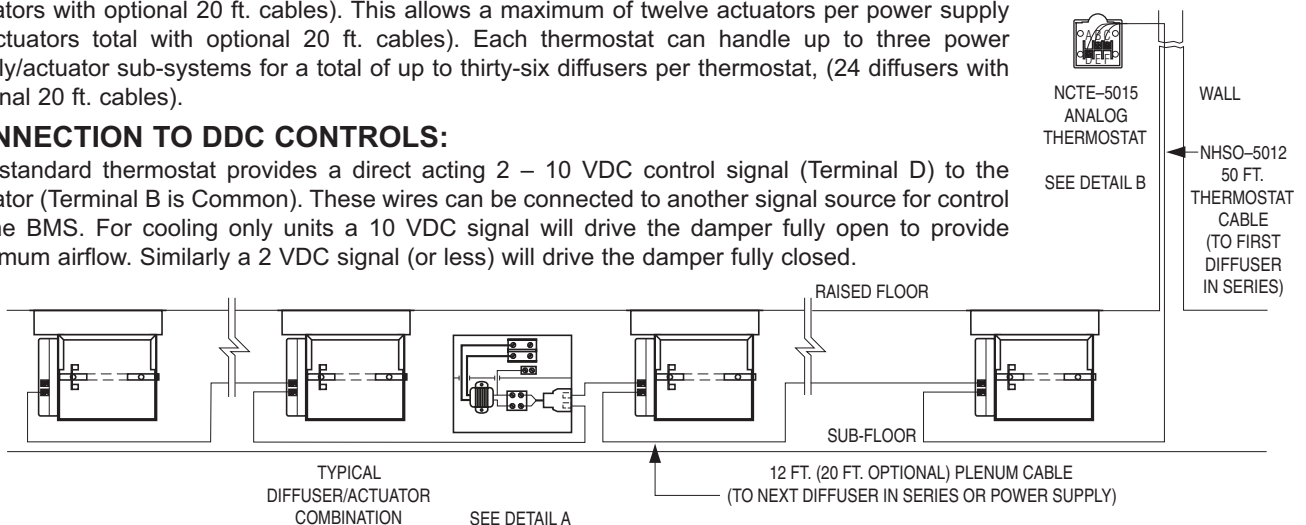

VAV LINEAR FLOOR DIFFUSERS

HOW TO SPECIFY OR TO ORDER

(Show complete Model Number and Size, unless "Default" is desired).

VAV Linear Floor Diffusers with Actuator – Square – Model NLYD

NLYD - VC - 10 1/2 x 10 1/2 - 480 - F - B - 12 - AW - DV

BASE MODEL

- VAV Linear Floor Diffuser with Actuator **NLYD**

PLENUM TYPE

- VAV Cooling Only **VC**
 - VAV Heating Only **VH**

NOMINAL SIZE

- 10 1/2 x 10 1/2 (267 x 267) (default)

CORE STYLE

- 1/8" (3) Bars – 1/4" (6) Spacing – 0° Deflection **480 (default)**
 - 1/8" (3) Bars – 1/4" (6) Spacing – 15° Deflection **481**
 - 1/4" (6) Bars – 1/2" (13) Spacing – 0° Deflection **240**
 - 1/4" (6) Bars – 1/2" (13) Spacing – 15° Deflection **241**
 - 1/4" (6) Bars – 1/2" (13) Spacing – 30° Deflection **243**

FRAME TYPE

- 1" (25) Heavy Duty Flange **F (default)**
 - 3/4" (19) Bevelled Heavy Duty Flange **H**

Note:

1. Thermostats, thermostat cable and power supplies have individual model numbers (see previous page).

OPTIONS

- Directional Vanes **DV**
 - Plenum Interior painted Black **BKP**

FINISH

- Appliance White (default) **AW**
 - Gray (textured) **GRT**
 - Black (textured) **BKT**
 - Aluminum **AL**
 - Satin (clear) anodized **SA**
 - Brushed clear-coat lacquer **BC**
 - Mill **MI**
 - Black **BK**
 - Special custom color (textured) **SPT**
 - Special custom color **SP**

ACTUATOR CABLE

- 12 ft. long (default) **12**
 - 20 ft. long **20**

FASTENING

- Friction spring clip (default) **B**
 - Countersunk screw holes **A**
 (Frame F only)

SUGGESTED SPECIFICATION:

Furnish and install **Nailor Model NLYD VAV Linear Floor Diffusers with Actuators** of the size and type shown on the plans and air distribution schedules. Units shall be complete with all connecting cables and power supply modules as shown. The diffusers shall incorporate heavy duty extruded aluminum linear grilles mounted in a heavy gauge galvanized steel plenum. The actuator shall be mounted within a protective enclosure. The entire assembly shall be tested and classified in accordance with UL Standard 2043. The diffuser shall meet all requirements of NFPA 90A. The plenum shall incorporate a 90 degree rotation low leakage damper and an integral 24 VAC direct drive actuator which operates from a 2 – 10 VDC control signal for precise airflow control. The actuator shall incorporate two RJ12 ports for simple interconnection using modular plenum rated cables and allowing multiple units to be daisy chained together. Each diffuser shall include a standard 12 ft. (20 ft. optional) modular plenum rated cable, for interconnection between diffusers, allowing diffusers to be spaced on 10 ft. (18 ft. optional) intervals. The plenum shall incorporate a dust/dirt collection area to catch anything that might fall through the diffuser face. Finish on visible surfaces shall be AW Appliance White baked enamel (other finishes are available).

Power supply modules shall be provided for each diffuser system as shown on the plans and air distribution schedules. Modules shall include a 120 volt control transformer (277, 240 or 460 volt optional) mounted and wired in a protective control enclosure. All electrical components shall be ETL or UL listed or recognized and installed in accordance with the National Electrical Code. The entire assembly shall be ETL listed and so labeled.

Each diffuser system shall be complete with a 50 ft. plenum rated cable for connection to a thermostat or to the DDC/BMS system as provided by others.

(Optional) Each zone shall be complete with an analog 2 – 10 VDC thermostat as shown on the plans. Thermostats shall incorporate advanced micro-computer electronics that include P+I control algorithms for precise temperature control. Thermostat shall have temperature setpoint adjustment in degrees Fahrenheit (Celsius optional) and include a light almond (ash white optional) setpoint cover.

The manufacturer shall provide published performance data for the diffuser, which shall be tested in accordance with ANSI/ASHRAE Standard 70 – 1991.

Performance Data

Model Series NLYD

Airflow, cfm	50	75	100	125	150
NC	-	-	-	-	18
22 Degree Blade Deflection					
Plenum Pressure, in w.g.	0.008	0.018	0.033	0.047	0.068
Vertical Projection, ft. @ 150, 100, 50 fpm	0-1.5-2	1.5-3-3.5	3-4-5	3.5-4.5-6	4.5-5.5-7
Horizontal Spread, ft. @ 150, 100, 50 fpm	0.5-1-1.5	1.5-2-2.5	1.5-3.5-5.5	2-3.5-7.5	2.5-4-9
45 Degree Blade Deflection					
Plenum Pressure, in w.g.	0.009	0.020	0.033	0.050	0.072
Vertical Projection, ft. @ 150, 100, 50 fpm	0-1-2	0.5-2-3	2.5-3-3.5	3.5-4-5	4.5-5-6
Horizontal Spread, ft. @ 150, 100, 50 fpm	0.5-1-2	0.5-2.5-4	1-2.5-5.5	2.5-4.5-8.5	4-6-11
60 Degree Blade Deflection					
Plenum Pressure, in w.g.	0.010	0.022	0.036	0.056	0.080
Vertical Projection, ft. @ 150, 100, 50 fpm	0-1-2	1.5-2.5-3.5	3-4-4.5	4-5-5	4.5-5.5-6
Horizontal Spread, ft. @ 150, 100, 50 fpm	0.5-1-1.5	1.5-2-3	1.5-2-5	2-3-7	3-4-8.5

Performance Notes:

- Projection and Spread data were determined in a room with an 11' ceiling height and 10°F ΔT, between supply air and averaged occupied room temperature.
- Vertical projection (throw) is the maximum height above the floor where terminal velocities of 150, 100 and 50 fpm were observed. Horizontal Spread is the total width of the isovel where terminal velocities of 150, 100 and 50 fpm were observed.
- Noise Criteria (values) based on 10 dB room absorption, re 10⁻¹² watts. Dash (-) in space denotes an NC value of less than 15.
- Tests conducted on units complete with directional vanes adjusted to the deflection settings of 22, 45 or 60 degrees. Damper fully open.
- Data derived from independent tests conducted in accordance with ANSI/ASHRAE Standard 70 – 1991.

PERFORMANCE TEST – MODEL NLYD @ 150 CFM

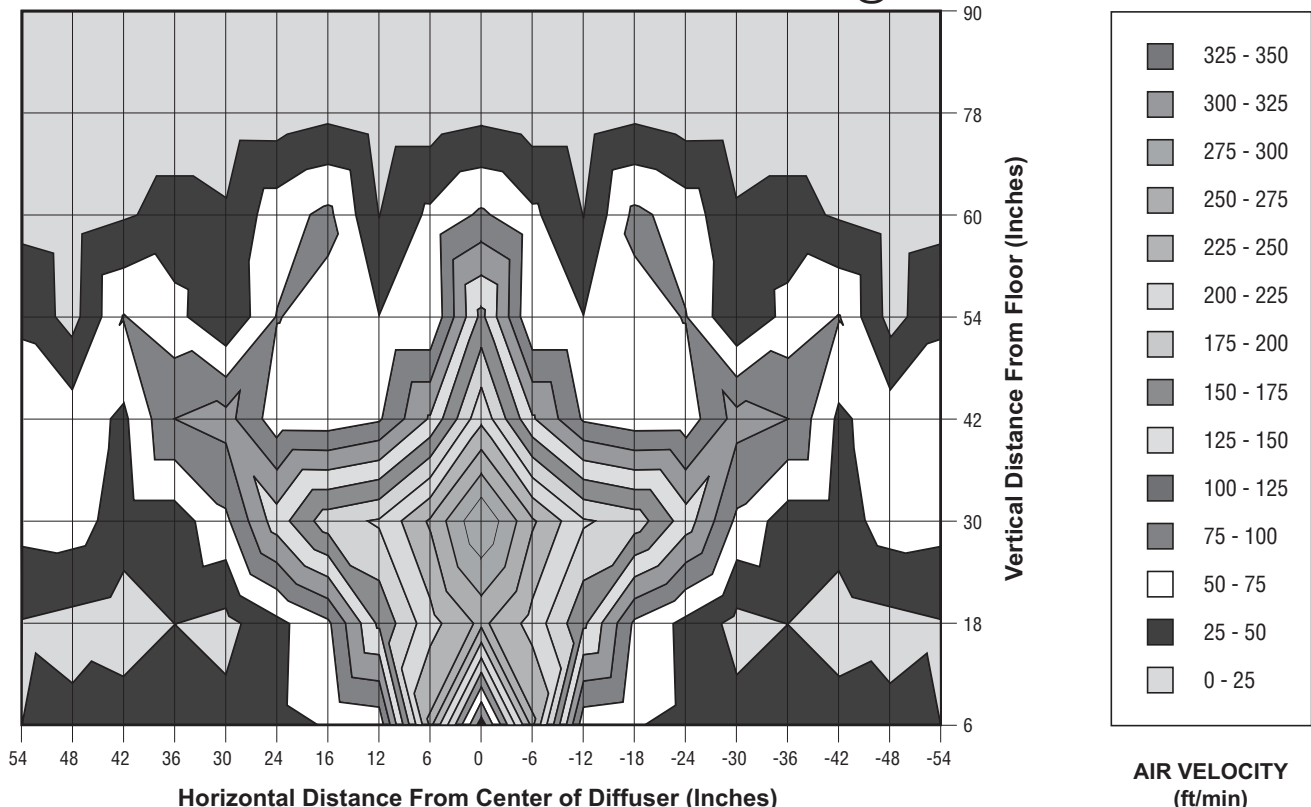

Note: The graph above shows actual air velocities and the associated isovels. This data was obtained in a full scale mock-up test performed on a standard Model NLYD @ 150 cfm with a 10°F ΔT and a 45° blade deflection.





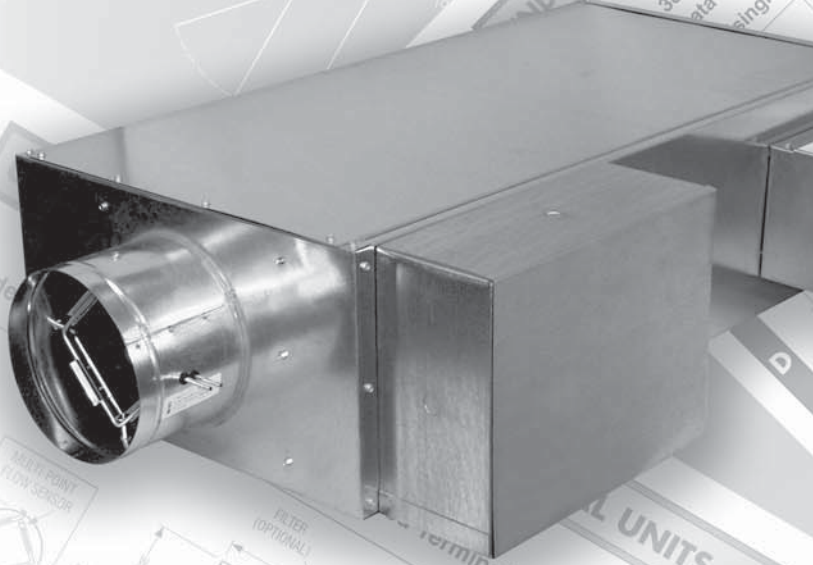

UNDERFLOOR FAN POWERED TERMINAL UNITS

 **Nailor**
Industries Inc.

Contents

	Page No.
Underfloor Fan Powered Terminal Units	
Model 38S, 38SE, 38SW	
Features, Options, Accessories	D3
Dimensional Data	
Model 38S	D4
Model 38SW with Hot water Coils	D5
Model 38SE with Electric Heat	D5
Performance Data	
Fan Curves	D6
NC Level Application Guide	D7
Discharge Sound Power Levels	D8
Radiated Sound Power Levels	D9
AHRI Certification and Performance Notes	D10
Performance Data Explanation	D11
Hot Water Coils	D12
Electric Heating Coils	D15
Controls	D18
Optional Terminal Unit Liners for 'IAQ' Sensitive Applications	D19
Suggested Specifications	D20

UNDERFLOOR FAN POWERED TERMINAL UNITS

SERIES FLOW CONSTANT VOLUME

38S SERIES

Models:

- | | |
|-------------|-----------------------|
| 38S | No Heat |
| 38SE | Electric Heat |
| 38SW | Hot Water Heat |

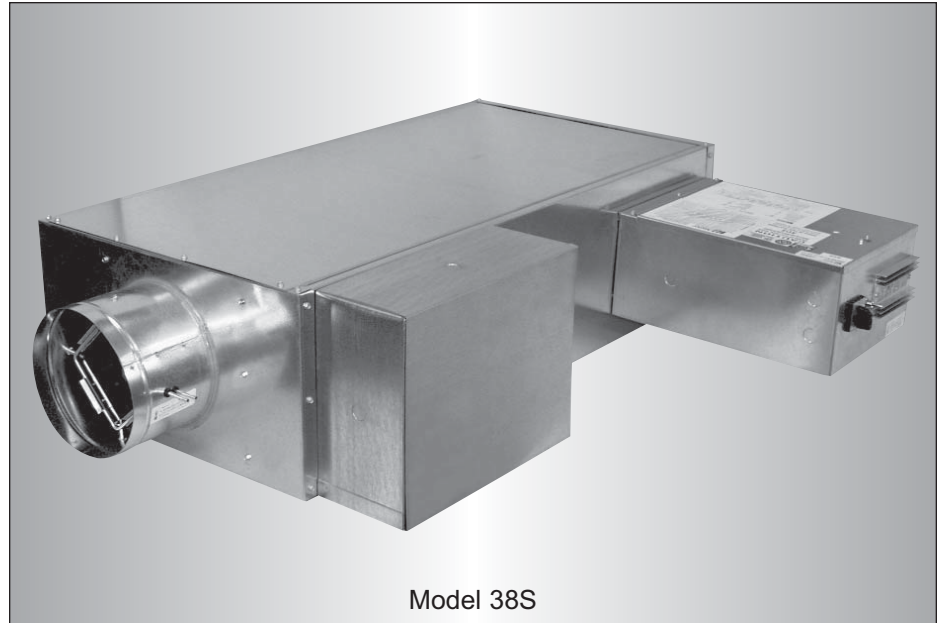

Model 38S

D

UNDERFLOOR FAN POWERED TERMINAL UNITS

The **Nailor Model Series 38S Underfloor Fan Powered Terminal Units** are specially engineered to meet the requirements of the most demanding underfloor applications where premium quality design and performance characteristics are desired. Features include an inclined opposed damper and our multi-point averaging 'Diamond Flow' sensor to provide precise airflow control and excellent sound performance. Compact, low profile unit casings, designed to accommodate the floor pedestal layout, feature convenient access to all components.

Designed to optimize energy efficiency the standard units feature ultra-high efficiency EPIC™/ECM motor technology. Additional options include electric or hot water supplementary heat, and various 'IAQ' linings including a solid metal liner.

STANDARD FEATURES:

- 20 ga. (1.0) galvanized steel construction.
- 16 ga. (1.6) galvanized steel inclined opposed blade primary air damper. 45° rotation, CW to close. 1/2" (13) dia. plated steel drive shaft. An indicator mark on the end of the shaft shows damper-position. Leakage is less than 2% of nominal flow at 3" w.g. (750 Pa).
- Multi-point averaging 'Diamond Flow' sensor.
- Perforated baffle on primary air discharge optimizes mixing with induced air for rapid and effective temperature equalization. The baffle also converts low frequency primary air valve generated sound into more readily attenuated higher frequencies.
- Pressure independent primary airflow control.
- Full size top access panel.
- 1/2" (13) dual density insulation. Exposed edges coated to prevent air erosion. Meets requirements of NFPA 90A and UL 181.

- Single point electrical connection.
- Discharge opening designed for flanged duct connection.
- Top access hinged door line voltage / fan controls enclosure.
- Full primary air valve low voltage enclosure for factory mounted DDC and analog electronic controls.
- Ultra-energy efficient ECM fan motor with overload protection. Solid state Nailor EPIC™ fan volume controller.
- Available with electric or hot water supplementary heat.
- All controls are mounted on exterior of terminal providing ready access for field adjustment.
- Each terminal factory tested prior to shipment.

CONTROLS:

- Analog electronic controls. Factory supplied, mounted and calibrated.
- Digital controls. Factory mounting and wiring of DDC controls supplied by BMS Controls Contractor.

OPTIONS AND ACCESSORIES:

- Primary air valve controls enclosure for field mounted controls.
- Filter frame and 1" (25)/2" (51) disposable filter.
- Rubber support feet.
- Toggle disconnect switch.
- Steri-liner.
- Fiber-free liner.
- Solid metal liner.
- Perforated metal liner.
- Fan unit fusing.
- Left-hand controls location.



Underfloor Fan Powered Terminal Units

Models: 38S • Unit Sizes 1, 3 and 5

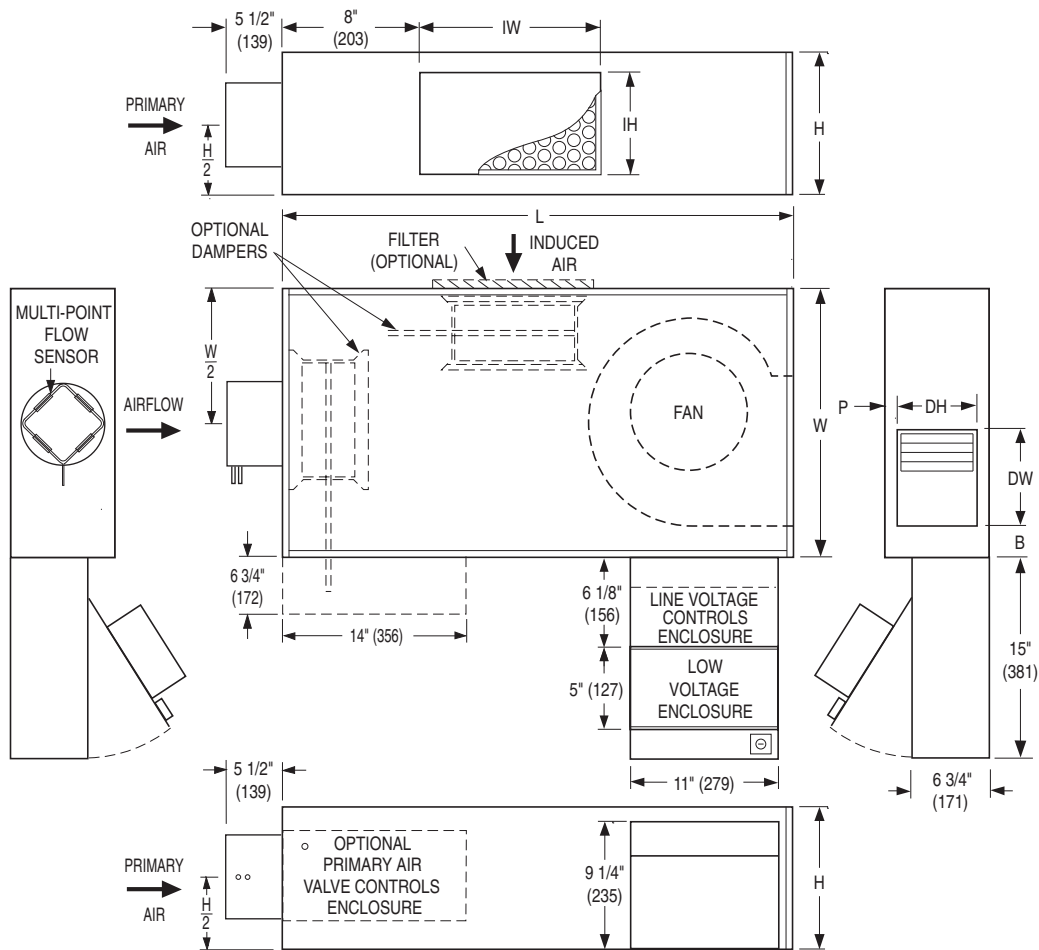

Dimensional Data. Imperial Units (inches)

Unit Size	Inlet Size	W	H	L	B	P	Inlet IW x IH	Outlet Discharge DW x DH	Filter Size
1	4, 5, 6	20	8 1/2	40	2 3/8	29/32	17 x 5 3/4	7 3/16 x 5 15/16	19 x 7
3	6, 8, 10	20	11	40	4 3/8	1 1/2	17 x 8	12 1/4 x 8	19 x 10
5	10,*12,*14*	20	15	44	1 1/4	2	17 x 12	13 1/4 x 11 1/2	20 x 15

Dimensional Data. Metric Units (mm)

Unit Size	Inlet Size	W	H	L	B	P	Inlet IW x IH	Outlet Discharge DW x DH	Filter Size
1	102, 127, 152	508	216	1016	60	23	432 x 146	183 x 151	483 x 178
3	152, 203, 254	508	279	1016	111	38	432 x 203	311 x 203	483 x 254
5	254*,305*,356*	508	381	1118	32	51	432 x 305	337 x 292	508 x 381

* Oval Inlets

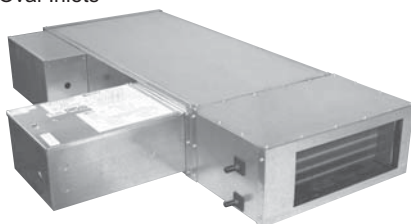

Model 38SW

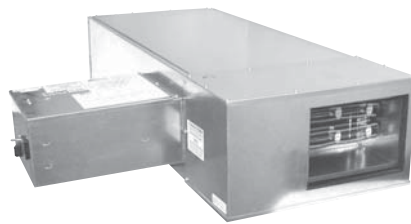

Model 38SE



A Participating Corporation in the ARI 880 Certification program.



Underfloor Fan Powered Terminal Units

Model Series: 38SW and 38SE • Unit Sizes 1, 3 and 5

Hot Water Coil Section

Model 38SW

Available in 1, 2 or 3 row. Coil section installed on unit discharge. Right hand coil connection looking in direction of airflow standard (shown). Left hand is optional (terminals are inverted). Connections must be selected same hand as controls enclosure location.

STANDARD FEATURES:

- Coil section installed on unit discharge.

- Coil (and header on multi-circuit units) is installed in insulated casing for increased thermal efficiency.

- 1/2" (13) copper tubes.
- Aluminum ripple fins.
- Sweat connections: One row 1/2" (13) O.D. male solder. Two and three row 7/8" (22) O.D. male solder.
- Top and bottom access

panels for inspection and coil cleaning.

- Flanged outlet duct connection.

Unit Size	Imperial Units (inches)			Metric Units (mm)		
	Outlet Duct Size C x D	H	J	Outlet Duct Size C x D	H	J
1	14 3/4 x 5 3/4	8 1/2	1	375 x 146	216	25
3	14 3/4 x 8 3/4	11	1 1/8	375 x 222	279	29
5	17 x 11 1/2	15	1 1/2	432 x 292	381	38

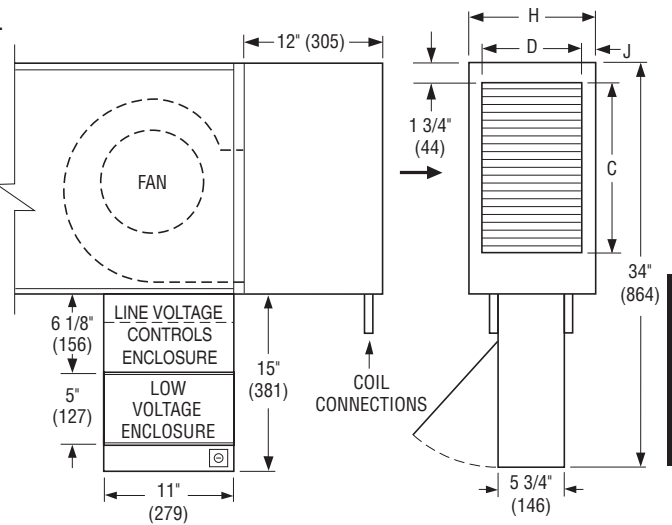

Electric Coil Section

Model: 38SE

STANDARD FEATURES:

- 20 ga. (1.0) galv. steel construction.
- Automatic reset high limit cut-outs (one per element).
- Controls enclosure incorporates a hinged access door opening upstream to help ensure NEC clearance and reduce footprint. FN2 (90° design) is standard.
- Controls mounted as standard on RHS as shown.
- Electric heater installed on unit discharge.
- Flanged outlet duct connection.
- Insulated heater element wrapper.
- Positive pressure airflow switch.

- Single point electric connection for the entire terminal unit.

- Terminal unit w/coil is ETL listed as an assembly.

Std. Supply Volt.(60 Hz):

Single phase:

- 120V • 208V • 220V* • 240V
- 277V • 347V • 380V* • 480V
- 600V

Three phase - delta configuration:

- 208V • 220V* • 240V

Three phase - wye configuration:

- 380V* • 480V • 600V

(Three phase is only available for size 3 & 5 boxes).

* Outside of the U.S.

OPTIONS:

- Class 'A'80/20 Ni./Cr. Wire.
- Door interlock disconnect switch.
- Dust tight construction.
- Left hand configuration.
- Manual reset secondary thermal cut-out.
- Mercury contactors.
- Power circuit fusing.
- Toggle disconnect switch.

Dimensional Data. Imperial Units (inches)

Unit Size	Outlet Discharge F x G	H	N	C	R	S
1	8 1/4 x 5 1/2	8 1/2	9	1 3/8	2	1
3	11 x 7 7/8	11	9	1	1 5/8	1 5/8
5	12 x 8 3/4	15	13 3/4	1	1	4

Dimensional Data. Metric Units (mm)

Unit Size	Outlet Discharge F x G	H	N	C	R	S
1	210 x 140	216	229	35	51	25
3	279 x 200	278	229	25	41	41
5	305 x 222	381	352	25	25	102

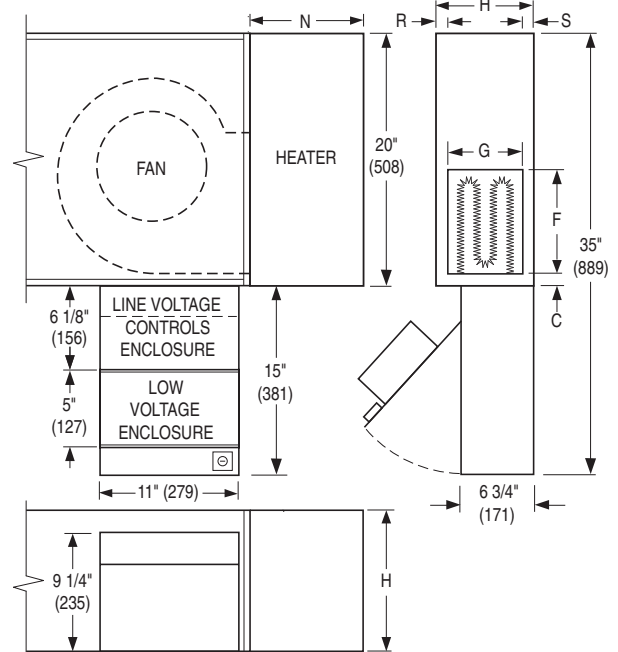

UNDERFLOOR FAN POWERED TERMINAL UNITS

Model Series 38S • Underfloor Fan Powered Terminal Units • Series Flow Performance Data • Fan Curves – Airflow vs. Downstream Static Pressure

ECM "Brushless DC" Motors

Unit Size 1

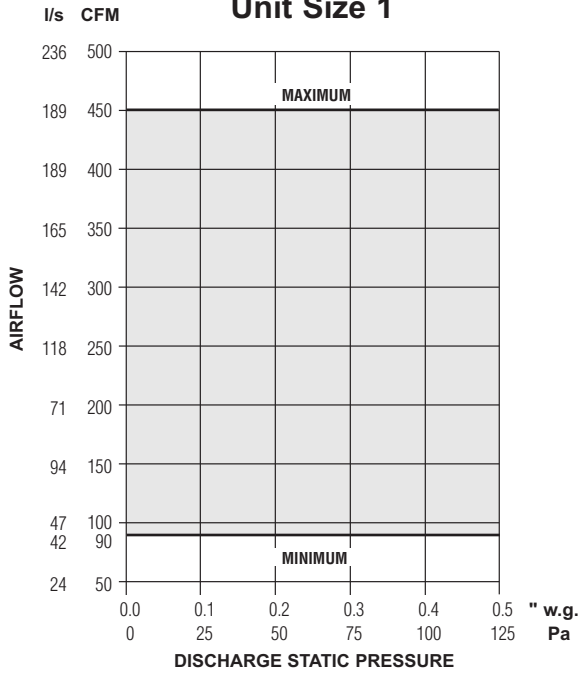

Unit Size 3

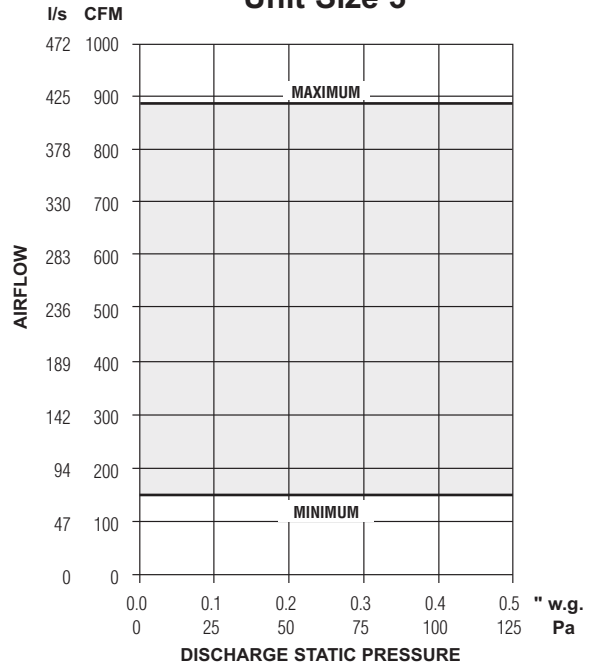

Unit Size 5

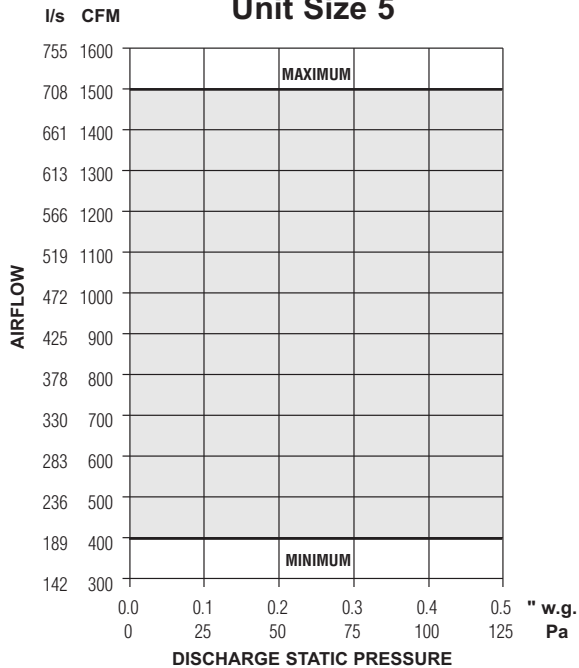

Electrical Data

Unit Size	ECM Motor FLA			
	Voltage	120/1/60	208/240/1/60	277/1/60
1	Watts	277	276	270
	FLA	3.7	1.9	1.9
3	Watts	420	450	410
	FLA	5.8	3.4	2.9
5	Watts	810	830	800
	FLA	12.6	5.7	5.9

FLA = Full load amperage

Notes:

- The fan curves for the ECM motor are unlike those for traditional PSC motors. The ECM motor is constant volume at factory or field set point and airflow does not vary with changing static pressure conditions. The motor compensates for any changes in external static pressure such as filter loading.
- Airflow can be set to operate on horizontal performance line at any point within shaded area using the solid state volume controller provided.
- Fan curves shown are applicable to 120/208/240 and 277 volt, single phase ECM motors. ECM motors, although DC in operation, include a built-in inverter.

D

UNDERFLOOR FAN POWERED TERMINAL UNITS

Performance Data • NC Level Application Guide

Model Series 38S • Series Flow (Constant Volume) • Basic Unit

Unit Size	Inlet Size	Airflow		Min. inlet ΔPs		NC Levels @ Inlet Pressure (ΔPs) shown											
						DISCHARGE					RADIATED						
						Fan Only	Min. ΔPs	0.5 w.g. (125 Pa)	1.0" w.g. (250 Pa)	1.5" w.g. (375 Pa)	2.0" w.g. (500 Pa)	Fan Only	Min. ΔPs	0.5" w.g. (125 Pa)	1.0" w.g. (250 Pa)	1.5" w.g. (375 Pa)	2.0" w.g. (500 Pa)
1	4	180	85	0.08	20	23	21	21	23	23	24	-	20	20	24	25	25
		140	66	0.05	12	20	-	-	20	-	20	-	-	-	22	23	23
		90	42	0.05	12	-	-	-	-	-	-	-	-	-	20	22	21
		40	19	0.05	12	-	-	-	-	-	-	-	-	-	-	21	20
	5	260	123	0.08	20	30	29	29	29	29	29	22	24	24	28	29	31
		200	94	0.05	12	24	24	24	24	24	25	-	20	21	25	26	28
		140	66	0.05	12	20	-	-	20	-	20	-	-	-	22	23	23
		70	33	0.05	12	-	-	-	-	-	-	-	-	-	-	22	21
	6	375	177	0.05	12	38	36	37	35	36	36	29	31	31	33	35	38
		300	142	0.05	12	34	33	33	33	33	33	26	26	26	29	31	32
		200	94	0.05	12	24	24	23	24	23	25	-	20	21	24	26	29
		100	47	0.05	12	20	-	-	-	-	-	-	-	-	22	24	23
3	6	325	153	0.08	20	-	-	-	-	-	-	26	28	29	32	33	34
		290	137	0.08	20	-	-	-	-	-	-	25	28	29	32	32	34
		200	94	0.05	12	-	-	-	-	-	-	23	25	26	31	31	33
		90	42	0.05	12	-	-	-	-	-	-	21	23	24	30	29	31
	8	575	271	0.08	20	25	25	26	26	28	28	31	32	34	35	37	38
		500	236	0.08	20	21	21	23	24	25	25	30	31	32	35	36	37
		350	165	0.05	12	-	-	-	-	-	-	26	29	30	33	33	35
		150	71	0.05	12	-	-	-	-	-	-	22	24	26	30	30	32
	10	900	425	0.05	12	38	38	38	37	38	41	37	38	38	39	41	43
		800	378	0.05	12	35	35	33	33	35	35	35	37	38	38	40	41
		550	260	0.05	12	26	26	26	28	28	29	31	33	35	37	39	39
		250	118	0.05	12	-	-	-	-	-	-	24	26	26	31	31	32
5	10	1100	519	0.08	20	38	26	29	29	30	31	44	39	40	40	40	41
		900	425	0.08	20	33	21	24	24	24	26	34	31	33	36	39	41
		700	330	0.05	12	24	-	-	-	20	21	30	25	29	34	37	39
		300	142	0.05	12	-	-	-	-	-	-	21	-	23	26	30	31
	12**	1500	708	0.08	20	45	35	36	36	34	37	45	37	39	40	44	45
		1200	566	0.08	20	39	27	29	29	30	31	45	38	39	39	39	40
		900	425	0.08	20	33	21	24	24	24	26	34	29	31	34	37	39
		600	283	0.06	15	21	-	-	-	-	20	28	23	26	32	35	37

**Flat oval inlet

Performance Notes:

1. NC Levels are calculated based on procedures as outlined on page D11.
2. Dash (-) in space indicates a NC less than 20.
3. Asterisk (*) in space indicates that the minimum inlet static pressure requirement is greater than 0.5" w.g. (125 Pa) at rated airflow.

Performance Data • Discharge Sound Power Levels

Model Series 38S • Series Flow (Constant Volume) • Basic Unit



Fiberglass Liner

Unit Size	Inlet Size	Airflow		Min. inlet ΔPs		Fan Only		Fan and 100% Primary Air – Sound Power Octave Bands @ Inlet pressure (ΔPs) shown																											
								Minimum ΔPs					0.5" w.g. (125Pa) ΔPs					1.0" w.g. (249Pa) ΔPs					1.5" w.g. (375Pa) ΔPs					2.0" w.g. (500Pa) ΔPs							
								2	3	4	5	6	7	2	3	4	5	6	7	2	3	4	5	6	7	2	3	4	5	6	7	2	3	4	5
1	4	180	85	0.08	20	65	63	65	62	58	56	64	62	64	61	57	55	64	62	64	60	56	54	64	63	64	61	57	55	64	63	64	61	57	55
		140	66	0.05	12	64	60	62	58	54	52	62	60	61	57	53	51	62	60	61	57	53	51	62	61	61	57	53	51	63	60	61	57	53	51
		90	42	0.05	12	62	56	59	53	50	47	60	56	58	52	49	46	59	56	58	52	49	46	60	58	58	53	49	47	61	57	58	53	49	47
		40	19	0.05	12	60	53	55	49	45	42	58	53	54	48	44	42	57	53	54	48	44	41	58	55	55	49	45	42	59	54	55	49	45	42
	5	260	123	0.08	20	69	69	71	69	65	63	67	68	70	68	64	62	67	68	69	67	63	62	67	68	69	67	63	62	68	68	69	67	63	62
		200	94	0.05	12	66	64	66	64	59	57	65	64	66	62	58	57	65	64	65	62	58	56	65	64	65	62	58	56	65	64	65	62	58	55
		140	66	0.05	12	64	60	62	58	54	52	62	60	61	57	53	51	62	60	61	57	53	51	62	61	61	57	53	51	63	60	61	57	53	51
		70	33	0.05	12	61	55	57	51	48	45	59	55	56	50	47	45	59	55	56	51	47	44	59	56	57	52	48	45	60	56	57	52	48	45
	6	375	177	0.05	12	76	77	78	79	74	73	73	75	77	78	73	72	73	76	76	77	73	72	73	74	76	76	71	71	73	75	74	76	71	71
		300	142	0.05	12	70	72	75	74	69	68	69	71	74	72	68	67	69	71	73	71	68	67	69	71	73	72	67	67	70	71	73	71	67	66
		200	94	0.05	12	64	64	68	64	60	59	63	64	68	63	60	58	63	63	66	62	59	57	64	64	67	62	59	57	64	63	67	62	59	57
		100	47	0.05	12	64	57	58	54	50	47	61	57	57	53	49	46	61	58	57	53	49	46	61	58	58	54	49	46	62	58	58	54	49	47
3	6	325	153	0.08	20	58	57	54	50	44	44	58	56	54	49	44	44	59	58	54	49	46	44	60	60	55	50	48	45	61	60	57	51	48	45
		290	137	0.08	20	57	55	53	48	43	42	57	55	53	48	42	42	58	57	53	48	44	42	59	59	54	49	47	43	60	59	56	49	47	44
		200	94	0.05	12	55	52	49	44	38	38	54	51	49	44	38	38	56	54	50	44	40	38	57	56	51	45	44	39	57	56	53	46	43	40
		90	42	0.05	12	51	48	45	39	33	33	51	47	45	39	32	33	53	51	46	40	35	33	55	53	48	41	39	35	55	53	50	41	39	35
	8	575	271	0.08	20	71	70	66	64	60	58	65	66	63	60	57	56	65	67	63	60	57	55	66	67	64	60	58	56	67	68	65	61	58	56
		500	236	0.08	20	63	63	61	57	53	52	63	63	61	57	53	52	63	64	61	57	54	52	64	65	61	57	55	52	65	66	62	58	55	53
		350	165	0.05	12	59	58	55	51	46	45	58	57	55	50	45	45	59	59	55	50	47	45	61	61	56	51	49	46	61	61	58	52	49	46
		150	71	0.05	12	53	50	48	42	36	36	53	50	47	42	35	35	54	53	48	42	38	36	56	55	50	43	42	37	56	55	51	44	41	38
	10	900	425	0.05	12	75	78	75	74	72	70	75	78	75	73	71	71	74	78	75	73	71	70	74	77	74	72	70	69	75	78	74	73	70	70
		800	378	0.05	12	72	75	71	71	68	66	71	75	72	70	68	67	71	73	71	69	66	65	70	73	70	68	66	65	72	75	71	69	67	66
		550	260	0.05	12	63	67	65	63	60	56	62	67	65	62	59	56	63	67	64	61	58	55	65	68	65	62	59	56	67	68	66	62	59	56
		250	118	0.05	12	57	53	50	45	39	40	57	53	50	44	38	40	58	56	51	45	41	40	59	58	52	46	45	41	58	57	54	46	44	42
5	10	1100	519	0.08	20	75	78	76	71	68	69	66	68	68	64	60	62	67	70	69	64	61	62	68	70	69	65	61	63	69	71	69	65	62	63
		900	425	0.08	20	71	73	71	67	64	64	61	63	66	60	56	57	65	66	66	61	58	58	65	66	66	61	58	58	67	66	67	62	59	59
		700	330	0.05	12	64	66	64	61	55	54	58	58	59	55	50	48	61	61	61	56	51	49	61	62	61	56	51	49	64	63	62	57	52	50
		300	142	0.05	12	57	55	55	51	44	41	56	54	54	49	43	40	57	54	54	50	43	40	57	55	55	50	44	40	57	55	54	50	44	41
	12**	1500	708	0.08	20	84	84	79	79	77	75	73	75	75	71	68	69	74	76	75	71	68	69	75	76	75	71	68	70	74	74	76	72	69	70
		1200	566	0.08	20	76	79	76	72	69	70	67	68	69	65	61	63	68	70	70	65	62	63	69	70	70	66	62	64	69	71	70	66	63	64
		900	425	0.08	20	71	73	71	67	64	64	61	63	66	60	56	57	65	66	66	61	58	58	65	66	66	61	58	58	67	66	67	62	59	59
		600	283	0.06	15	63	63	63	58	54	53	57	58	58	53	49	47	59	59	59	54	49	47	60	60	59	54	49	47	63	61	60	55	50	48

**Flat oval inlet

For performance table notes, see page D10; highlighted numbers indicate embedded AHRI certification points.

UNDERFLOOR FAN POWERED TERMINAL UNITS D

Performance Data • Radiated Sound Power Levels

Model Series 38S • Series Flow (Constant Volume) • Basic Unit

Fiberglass Liner



Unit Size	Inlet Size	Airflow		Min. inlet ΔPs		Fan Only		Fan and 100% Primary Air – Sound Power Octave Bands @ Inlet pressure (ΔPs) shown																																	
								Minimum ΔPs					0.5" w.g. (125Pa) ΔPs					1.0" w.g. (249Pa) ΔPs					1.5" w.g. (375Pa) ΔPs					2.0" w.g. (500Pa) ΔPs													
								2	3	4	5	6	7	2	3	4	5	6	7	2	3	4	5	6	7	2	3	4	5	6	7	2	3	4	5	6	7				
1	4	180	85	0.08	20	54	43	43	39	34	30	58	47	44	38	32	28	58	49	45	42	36	32	58	51	50	49	42	38	59	52	51	51	45	43	60	52	51	52	47	47
		140	66	0.05	12	52	40	41	36	32	28	56	45	41	35	30	26	57	47	43	40	34	30	56	48	48	48	41	37	56	49	49	51	44	42	58	49	49	51	46	45
		90	42	0.05	12	50	37	38	33	29	26	54	41	38	32	28	24	55	44	40	37	33	28	53	45	46	47	40	35	54	46	47	50	44	40	55	45	46	49	45	43
		40	19	0.05	12	48	34	35	30	27	23	52	38	35	28	26	22	53	41	38	35	31	27	51	42	44	47	38	33	51	43	44	49	43	38	52	42	43	48	44	42
	5	260	123	0.08	20	58	48	48	44	38	34	61	53	49	43	36	31	61	54	50	45	39	35	62	55	53	50	44	41	63	56	54	52	46	46	64	58	56	54	49	50
		200	94	0.05	12	55	44	44	40	35	31	58	49	45	39	33	29	59	50	46	42	37	33	59	52	51	49	42	39	60	53	52	51	45	44	61	54	53	52	47	48
		140	66	0.05	12	52	40	41	36	32	28	56	45	41	35	30	26	57	47	43	40	34	30	56	48	48	48	41	37	56	49	49	51	44	42	58	49	49	51	46	45
		70	33	0.05	12	49	36	36	32	28	25	53	40	37	30	27	23	54	43	39	36	32	28	52	44	45	47	39	34	53	45	46	50	43	39	54	44	45	49	45	43
	6	375	177	0.05	12	63	56	54	52	44	40	66	60	56	51	42	36	66	60	56	51	43	40	68	62	58	53	47	46	69	63	60	55	49	49	70	67	63	59	52	54
		300	142	0.05	12	59	51	52	47	40	36	61	55	52	45	37	33	62	56	52	47	40	37	64	58	54	50	44	42	65	59	56	52	47	47	66	61	57	54	49	52
		200	94	0.05	12	55	44	45	40	36	31	56	49	46	39	33	29	57	51	47	42	37	32	59	53	50	46	43	40	60	53	52	49	45	44	60	56	54	51	47	47
		100	47	0.05	12	50	38	38	34	30	26	56	42	38	33	29	24	57	44	41	38	33	29	54	45	47	50	40	35	54	47	47	52	44	40	56	45	46	51	46	44
3	6	325	153	0.08	20	51	48	52	46	36	28	54	53	53	46	34	26	60	56	54	52	50	50	62	57	57	56	53	57	59	57	58	57	55	60	60	58	59	58	56	61
		290	137	0.08	20	50	47	51	45	35	27	53	52	53	45	33	25	59	56	54	52	51	51	62	56	57	55	53	57	58	56	57	57	55	60	59	57	59	58	56	62
		200	94	0.05	12	47	45	49	43	33	25	50	50	51	43	31	23	57	54	52	50	51	52	60	55	56	55	54	58	56	54	56	56	55	61	57	55	58	57	55	62
		90	42	0.05	12	43	42	47	40	30	23	47	48	49	40	28	20	55	52	50	49	51	53	59	53	55	54	54	59	54	52	54	55	55	61	54	52	56	55	55	62
	8	575	271	0.08	20	65	57	59	56	46	36	62	58	57	52	40	32	65	61	59	55	49	47	66	61	60	58	53	54	71	66	65	63	53	48	66	63	63	62	57	61
		500	236	0.08	20	56	52	55	51	41	31	60	57	56	50	38	30	63	59	57	54	50	48	65	60	60	57	53	55	63	60	61	59	55	59	64	62	62	61	57	61
		350	165	0.05	12	52	48	52	47	37	28	55	53	54	46	34	27	60	57	55	52	50	50	63	57	58	56	53	56	60	57	58	58	55	60	60	58	60	59	56	61
		150	71	0.05	12	45	43	48	42	32	24	49	49	50	42	30	22	56	53	52	50	51	52	60	54	55	54	54	59	55	53	55	55	61	56	54	57	56	55	62	
	10	900	425	0.05	12	69	62	62	60	51	40	72	65	62	58	47	40	71	65	63	58	48	43	70	66	64	59	51	49	73	68	66	63	55	56	74	70	67	66	57	59
		800	378	0.05	12	67	59	60	58	49	38	70	64	62	57	46	38	69	64	63	57	47	43	69	65	63	59	51	50	70	67	65	63	54	55	71	69	66	65	58	61
		550	260	0.05	12	58	52	56	53	43	32	62	58	58	53	41	32	66	62	60	58	53	53	66	64	62	60	56	60	66	64	64	62	57	62	65	64	64	63	57	63
		250	118	0.05	12	49	46	50	44	34	26	52	51	52	43	31	24	58	54	52	50	49	48	61	54	56	54	52	55	57	54	56	55	54	58	58	55	57	57	55	60
5	10	1100	519	0.08	20	66	65	68	66	61	61	57	61	64	60	52	54	63	63	65	60	53	54	64	63	65	61	53	55	64	64	65	61	54	55	65	65	66	61	54	55
		900	425	0.08	20	67	56	59	56	46	40	59	54	56	49	38	55	64	59	58	53	49	46	65	62	61	57	57	54	68	64	64	60	60	61	69	69	66	62	62	64
		700	330	0.05	12	61	50	55	52	42	36	58	52	51	45	34	31	60	55	54	51	48	44	63	60	59	55	56	52	65	63	62	58	59	58	66	65	64	60	61	62
		300	142	0.05	12	54	43	47	43	33	29	52	45	44	38	28	25	54	51	49	47	42	38	56	53	52	50	50	47	56	55	55	53	54	53	56	55	56	55	57	57
	1500	708	0.08	20	78	67	68	65	56	52	70	64	62	57	47	44	72	66	64	58	51	50	74	68	65	61	56	56	75	68	68	63	59	62	74	72	69	65	61	65	
	12**	1200	566	0.08	20	67	66	69	67	62	62	61	60	63	59	51	53	62	62	64	59	52	53	63	62	64	60	52	54	63	63	64	60	53	54	64	64	65	60	53	54
900		425	0.08	20	67	56	59	56	46	40	58	53	54	47	36	32	63	58	56	51	47	44	64	61	59	55	55	52	67	63	62	58	58	59	68	68	64	60	60	62	
600	283	0.06	15	60	49	53	50	40	34	57	51	49	43	32	29	59	54	52	49	46	42	62	59	57	53	54	50	64	62	60	56	57	56	65	64	62	58	59	60		

**Flat oval inlet

For performance table notes, see page D10; highlighted numbers indicate embedded AHRI certification points.

Performance Data • AHRI Certification and Performance Notes

Model Series 38S • Series Flow (Constant Volume) • Basic Unit • AHRI Certification Rating Points
Fiberglass Liner

Unit Size	Inlet Size	Fan CFM		Fan Watts	Fan Only** @ .25" w.g. (62 Pa) ΔPs														Fan + 100% Primary @ 1.5" w.g. (375 Pa) ΔPs w/ .25" w.g. (62 Pa) Discharge ΔPs									
					Discharge							Radiated							Primary CFM	Min. Inlet ΔPs		Radiated						
					2	3	4	5	6	7	2	3	4	5	6	7	cfm	l/s				"w.g.	Pa	2	3	4	5	6
1	4	180	85	277	65	63	65	62	58	56	54	43	43	39	34	30	180	85	0.08	20	59	52	51	51	45	43		
	5	260	123	277	69	69	71	69	65	63	58	48	48	44	38	34	260	123	0.08	20	63	56	54	52	46	46		
	6	375	177	140	76	77	78	79	74	73	63	56	54	52	44	40	375	177	0.05	12	69	63	60	55	49	49		
3	6	325	153	450	58	57	54	50	44	44	51	48	52	46	36	28	325	153	0.08	20	59	57	58	57	55	60		
	8	575	271	140	71	70	66	64	60	58	65	57	59	56	46	36	575	271	0.08	20	71	66	65	63	53	48		
	10	900	425	450	75	78	75	74	72	70	69	62	62	60	51	40	900	425	0.05	12	73	68	66	63	55	56		
5	10	1100	519	1080	75	78	76	71	68	69	66	65	68	66	61	61	1100	519	0.08	20	64	64	65	61	54	55		
	12	1500	708	880	84	84	79	79	77	75	78	67	68	65	56	52	1500	708	0.08	20	75	68	68	63	59	62		

Motor = ECM.

**Primary air valve is closed and therefore primary cfm is zero.



Ratings are certified in accordance with AHRI Standards.

Performance Notes for Sound Power Levels:

- Discharge (external) static pressure is 0.25" w.g. (63 Pa) in all cases, which is the difference (ΔPs) in static pressure from terminal discharge to the room.
Discharge Sound Power Levels (SWL) now include duct end reflection energy as part of the standard rating. Including the duct end correction provides sound power levels that would normally be transmitted into an acoustically, non-reflective duct. The effect of including the energy correction to the discharge SWL, is higher sound power levels when compared to previous AHRI certified data. For more information on duct end reflection calculations see AHRI Standard 880.
- Radiated sound power is the breakout noise transmitted through the unit casing walls.
- Sound power levels are in decibels, dB re 10⁻¹² watts.

- All sound data listed by octave bands is raw data without any corrections for room absorption or duct attenuation. Dash (-) in space indicates sound power level is less than 20 dB or equal to background.
- Min. inlet ΔPs is the minimum operating pressure of the primary air valve section.
- Asterisk (*) in space indicates that the minimum inlet static pressure requirement is greater than 0.5" w.g. (125 Pa) at rated airflow.
- Data derived from independent tests conducted in accordance with ANSI / ASHRAE Standard 130 and AHRI Standard 880.

Performance Data Explanation

Sound Power Levels vs. NC Levels

The **Nailor Model Series: 38S** underfloor fan powered terminal unit performance data is presented in two forms.

The laboratory obtained discharge and radiated sound power levels in octave bands 2 through 7 (125 through 4000 Hz) center frequency for each unit size at various flow rates and inlet static pressures is presented. This data is derived in accordance with ANSI/ASHRAE Standard 130-2008 and AHRI Standard 880-2011. This data is "raw" with no attenuation deductions and includes AHRI Certification standard rating points.

Nailor also provides an "NC Level" table as an application aid in terminal selection, which include attenuation allowances as explained below. The suggested attenuation allowances are typical and are not representative of specific job site conditions. It is recommended that the sound power level data be used and a detailed NC calculation be performed using the procedures outlined in AHRI 885-2011 for accurate space sound levels.

Explanation of NC Levels

Tabulated NC levels are based on attenuation values as outlined in AHRI Standard 885-2011 "Procedure for Estimating Occupied Space Sound Levels in the Application of Air Terminals and Air Outlets". AHRI Standard 885-2011, Appendix E provides typical sound attenuation values for air terminal discharge sound and air terminal radiated sound.

As stated in AHRI-885-2011, Appendix E, "These values can be used as a quick method of estimating space sound levels when a detailed evaluation is not available. The typical attenuation values are recommended for use by manufacturers to estimate application sound levels. In product catalogs, the end use environments are not known and the following factors are provided as typical attenuation values. Use of these values will allow better comparison between manufacturers and give the end user a value which will be expected to be applicable for many types of space."

Radiated Sound

Table E1 of Appendix E provides typical radiated sound attenuation values for three types of ceiling: Type 1 – Glass Fiber; Type 2 – Mineral Fiber; Type 3 – Solid Gypsum Board. Since Mineral Fiber tile ceilings are the most common construction used in commercial buildings, these values have been used to tabulate Radiated NC levels.

The following table provides the calculation method for the radiated sound total attenuation values based on AHRI Standard 885-2011.

	Octave Band					
	2	3	4	5	6	7
Environmental Effect	2	1	0	0	0	0
Ceiling/Space Effect	16	18	20	26	31	36
Total Attenuation Deduction	18	19	20	26	31	36

The ceiling/space effect assumes the following conditions:

1. 5/8" (16) tile, 20 lb/ft³ (320 kg/m³) density.
2. The plenum is at least 3 feet (914) deep.
3. The plenum space is either wide [over 30 feet (9 m)] or lined with insulation.
4. The ceiling has no significant penetration directly under the unit.

Discharge Sound

Table E1 of Appendix E provides typical discharge sound attenuation values for three sizes of terminal unit.

1. Small box; Less than 300 cfm (142 l/s)
[Discharge Duct 8" x 8" (203 x 203)].
2. Medium box; 300 – 700 cfm (142 - 330 l/s)
[Discharge Duct 12" x 12" (305 x 305)].
3. Large box; Greater than 700 cfm (330 l/s)
[Discharge Duct 15" x 15" (381 x 381)].

These attenuation values have been used to tabulate Discharge NC levels applied against the terminal airflow volume and not terminal unit size.

The following tables provide the calculation method for the discharge sound total attenuation values based on AHRI Standard 885-2011.

Small Box < 300 cfm	Octave Band					
	2	3	4	5	6	7
Environmental Effect	2	1	0	0	0	0
5 ft. (1.5 m) 1" (25) Duct Lining	2	6	12	25	29	18
Branch Power Division (1 outlet)	0	0	0	0	0	0
5 ft. (1.5 m), 8 in. dia. (203) Flex Duct	5	10	19	19	21	12
End Reflection	10	5	20	1	0	0
Space Effect	5	6	7	8	9	10
Total Attenuation Deduction	24	28	39	53	59	40

Medium Box 300 – 700 cfm	Octave Band					
	2	3	4	5	6	7
Environmental Effect	2	1	0	0	0	0
5 ft. (1.5 m) 1" (25) Duct Lining	2	4	10	20	20	14
Branch Power Division (2 outlets)	3	3	3	3	3	3
5 ft. (1.5 m), 8 in. dia. (203) Flex Duct	5	10	19	19	21	12
End Reflection	10	5	2	1	0	0
Space Effect	5	6	7	8	9	10
Total Attenuation Deduction	27	29	40	51	53	39

Large Box >700 cfm	Octave Band					
	2	3	4	5	6	7
Environmental Effect	2	1	0	0	0	0
5 ft. (1.5 m) 1" (25) Duct Lining	2	3	9	18	17	12
Branch Power Division (3 outlets)	5	5	5	5	5	5
5 ft. (1.5 m), 8 in. dia. (203) Flex Duct	5	10	19	19	21	12
End Reflection	10	5	2	1	0	0
Space Effect	5	6	7	8	9	10
Total Attenuation Deduction	29	30	41	51	52	39

1. Flexible duct is non-metallic with 1" (25) insulation.
2. Space effect (room size and receiver location) 2500 ft.³ (69 m³) and 5 ft. (1.5 m) distance from source.

For a complete explanation of the attenuation factors and the procedures for calculating room NC levels, please refer to the acoustical engineering guidelines at the back of this catalog and AHRI Standard 885-2011.

Model Series 38SW • Underfloor Fan Powered Terminal Units • Series Flow Performance Data • Hot Water Coils • Unit Size 1

1 Row (single circuit)

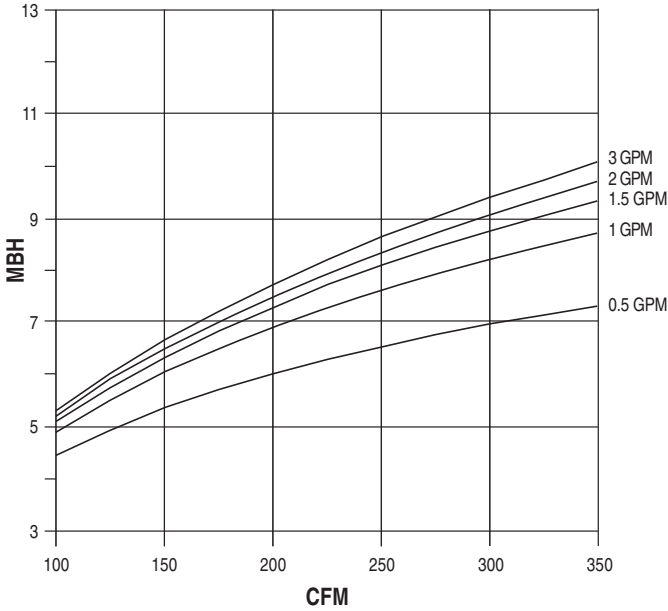

2 Row (multi-circuit)

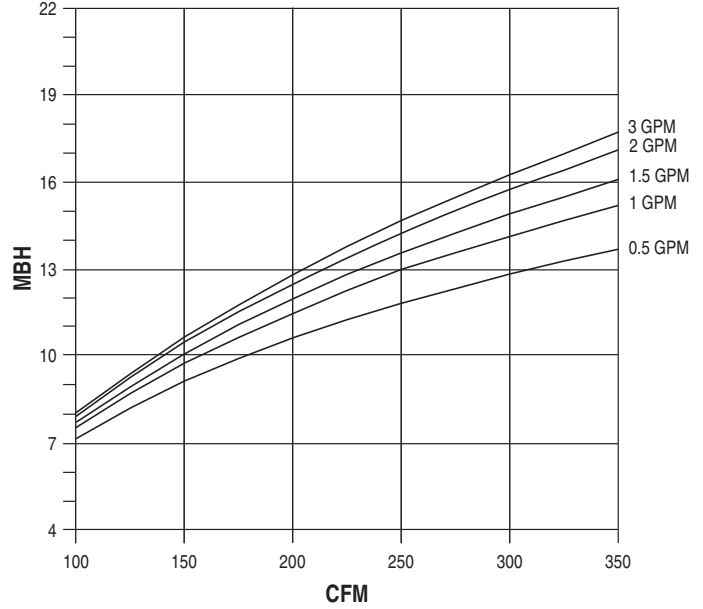

3 Row (multi-circuit)

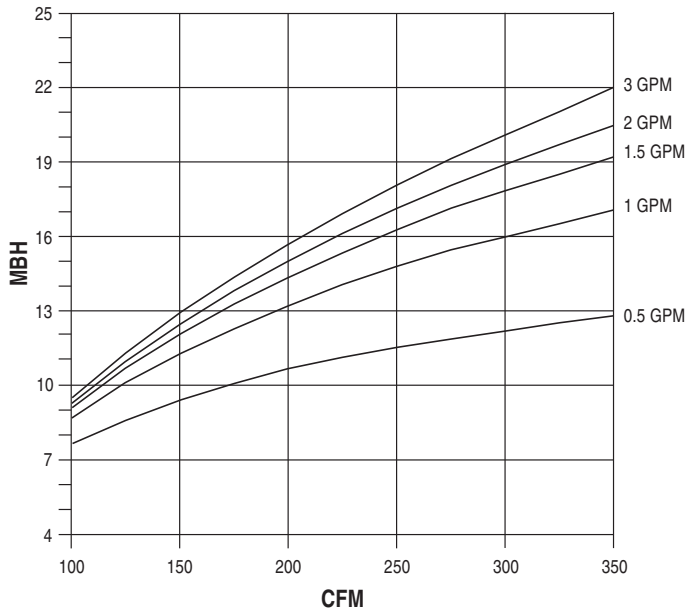

Water Pressure Drop

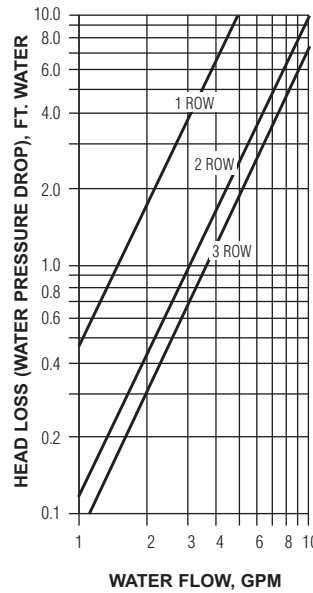

Air Pressure Drop

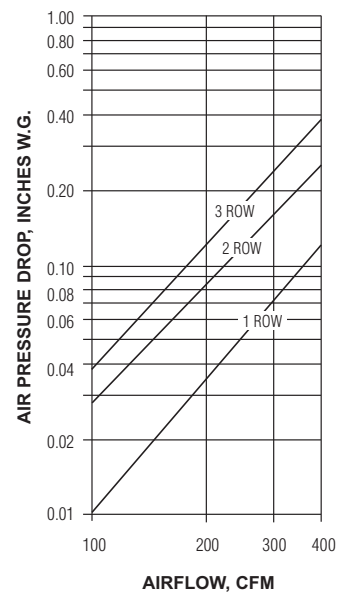

Notes:

- Capacities are in Mbh (thousands of Btu per hour).
- Mbh values are based on a ΔT (temperature difference) of 110°F between entering air and entering water. For other ΔT 's; multiply the Mbh values by the factors below.
- Air Temperature Rise. $ATR = 927 \times \frac{Mbh}{cfm}$
- Water Temp. Drop. $WTD = 2.04 \times \frac{Mbh}{GPM}$
- Connections: 1 Row 1/2" (13), 2 and 3 Row 7/8" (22); O.D. male solder.

Correction factors at other entering conditions:

ΔT °F	50	60	70	80	90	100	110	120	130	140	150
Factor	.455	.545	.636	.727	.818	.909	1.00	1.09	1.18	1.27	1.36

Altitude Correction Factors:

Altitude (ft.)	Sensible Heat Factor
0	1.00
2000	0.94
3000	0.90
4000	0.87
5000	0.84
6000	0.81
7000	0.78

D

UNDERFLOOR FAN POWERED TERMINAL UNITS

Model Series 38SW • Underfloor Fan Powered Terminal Units • Series Flow Performance Data • Hot Water Coils • Unit Size 3

1 Row (single circuit)

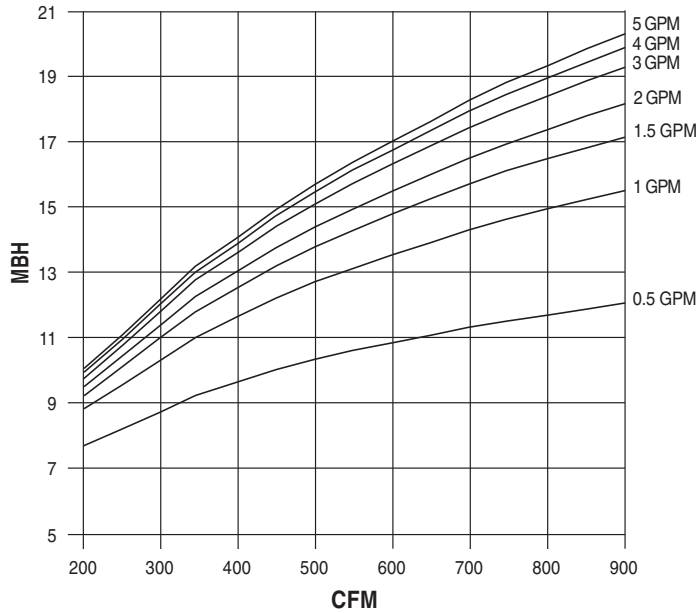

2 Row (multi-circuit)

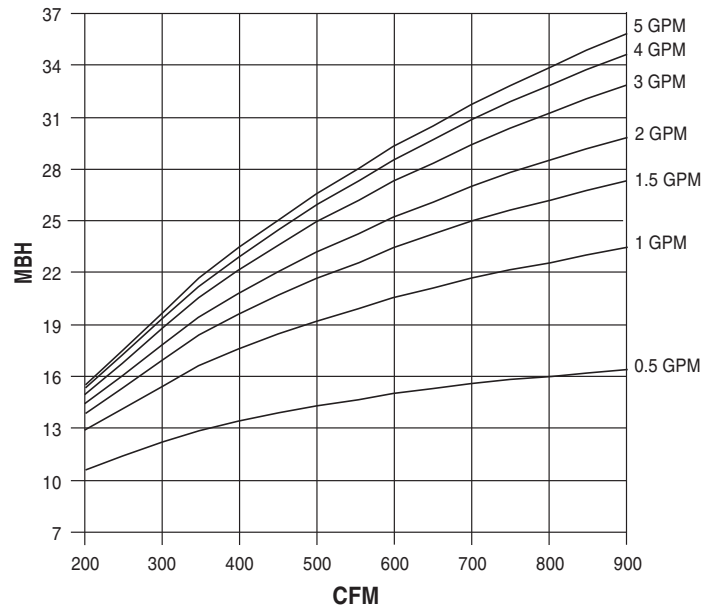

3 Row (multi-circuit)

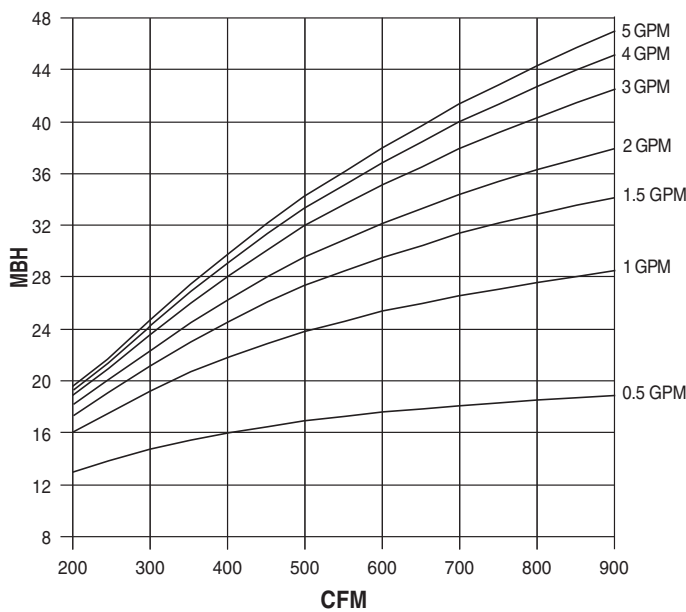

Water Pressure Drop

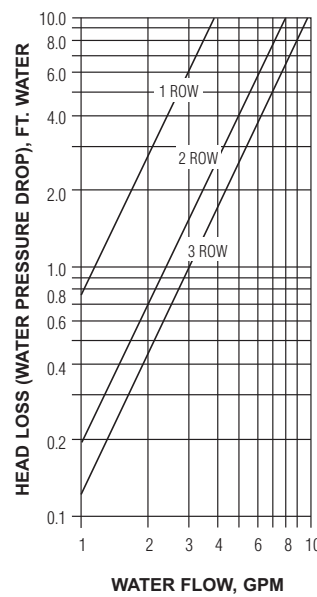

Air Pressure Drop

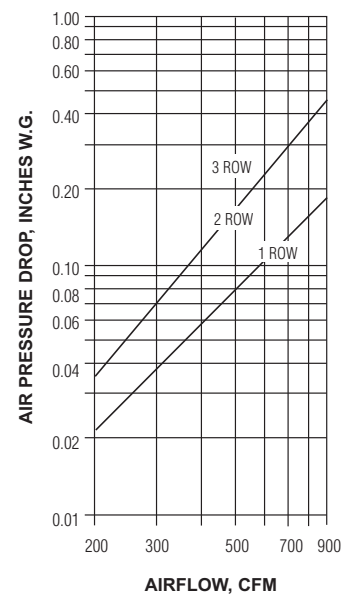

Notes:

- Capacities are in Mbh (thousands of Btu per hour).
- Mbh values are based on a ΔT (temperature difference) of 110°F between entering air and entering water. For other ΔT 's; multiply the Mbh values by the factors below.
- Air Temperature Rise. $ATR = 927 \times \frac{Mbh}{cfm}$
- Water Temp. Drop. $WTD = 2.04 \times \frac{Mbh}{GPM}$
- Connections: 1 Row 1/2" (13), 2 and 3 Row 7/8" (22); O.D. male solder.

Correction factors at other entering conditions:

ΔT °F	50	60	70	80	90	100	110	120	130	140	150
Factor	.455	.545	.636	.727	.818	.909	1.00	1.09	1.18	1.27	1.36

Altitude Correction Factors:

Altitude (ft.)	Sensible Heat Factor
0	1.00
2000	0.94
3000	0.90
4000	0.87
5000	0.84
6000	0.81
7000	0.78

D

UNDERFLOOR FAN POWERED TERMINAL UNITS

Model Series 38SW • Underfloor Fan Powered Terminal Units • Series Flow Performance Data • Hot Water Coils • Unit Size 5

1 Row (single circuit)

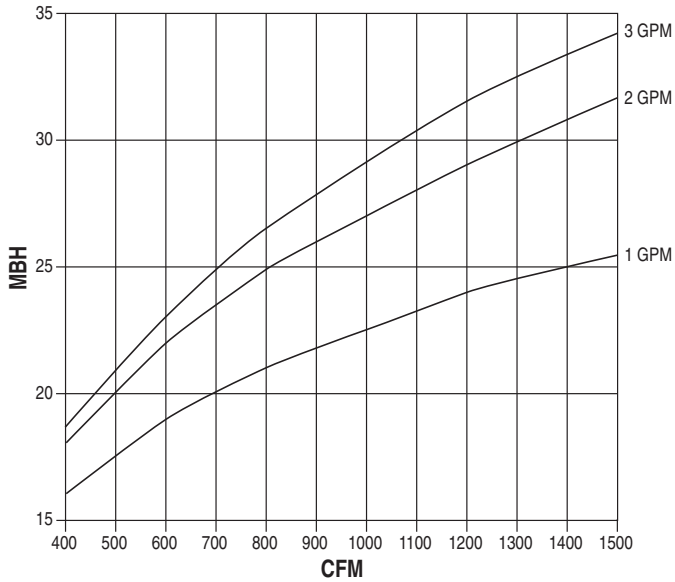

2 Row (multi-circuit)

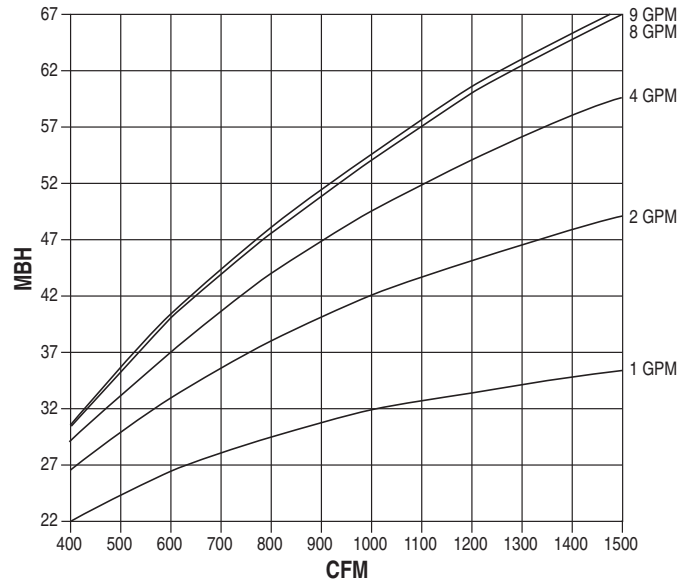

Water Pressure Drop

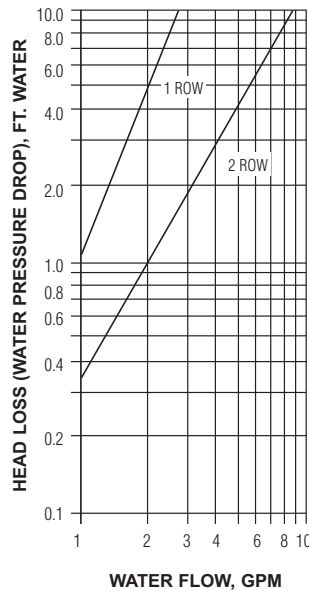

Air Pressure Drop

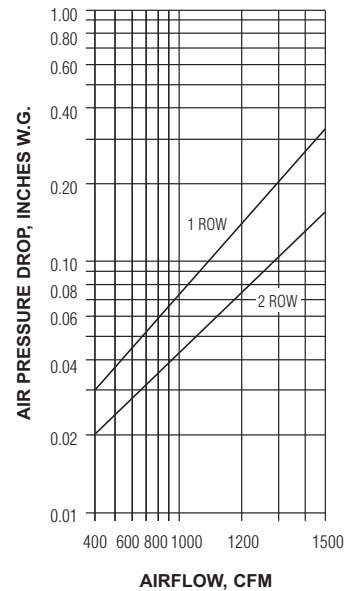

Notes:

- Capacities are in Mbh (thousands of Btu per hour).
- Mbh values are based on a ΔT (temperature difference) of 110°F between entering air and entering water. For other ΔT 's; multiply the Mbh values by the factors below.
- Air Temperature Rise. $ATR = 927 \times \frac{\text{Mbh}}{\text{cfm}}$
- Water Temp. Drop. $WTD = 2.04 \times \frac{\text{Mbh}}{\text{GPM}}$
- Connections: 1 Row 1/2" (13), 2 and 3 Row 7/8" (22); O.D. male solder.

Correction factors at other entering conditions:

ΔT °F	50	60	70	80	90	100	110	120	130	140	150
Factor	.455	.545	.636	.727	.818	.909	1.00	1.09	1.18	1.27	1.36

Altitude Correction Factors:

Altitude (ft.)	Sensible Heat Factor
0	1.00
2000	0.94
3000	0.90
4000	0.87
5000	0.84
6000	0.81
7000	0.78

D

UNDERFLOOR FAN POWERED TERMINAL UNITS

Electric Heating Coils • Construction Features, Selection and Capacities

Nailor Electric Coils are tested with the fan terminal in accordance with UL Standard 1995 and meet all requirements of the National Electric Code and CSA. Units are listed and labeled by the ETL Testing Laboratory as a total package. All controls are enclosed in a NEMA 1 electrical enclosure on the side of the fan package for easy access.

All wiring for the motor and heater terminates in the enclosure for single point electrical connection in the field. Each unit is supplied with a wiring diagram. Note: NEC requires a means to disconnect the heater power supply within sight or on the terminal.

Standard Features Include:

- Automatic reset high limit thermal cut-outs.
- Nickel-chrome heating elements.
- Magnetic contactors per stage on terminals with DDC or analog electronic controls.
- P.E. switch per stage to carry load or pilot duty with magnetic contactors as required with pneumatic control.
- Positive pressure airflow safety switch or CT relay.
- Fan relay for DDC fan coils.
- Control voltage transformer (Class 2) for DDC or analog electronic fan coils.

Optional Accessories:

- Toggle disconnect switch.
- Door interlocking disconnect switch.
- Mercury contactors.
- Power circuit fusing.
- Dust tight control enclosure.
- Class 'A' 80/20 nickel/chrome element wire.
- Manual reset high limits.
- SCR Control.



Tested and approved to the following standards:

ANSI/UL
1996, 1st ed.
CSA C22.2
No. 155-M1986.
UL 1995

SCR Control Option:

The SCR (Thyrister) option provides infinite solid state heater control using a proportional signal (0 – 10 Vdc or 4 – 20 mA). This option may be specified compatible with analog electronic or digital (DDC) controls.

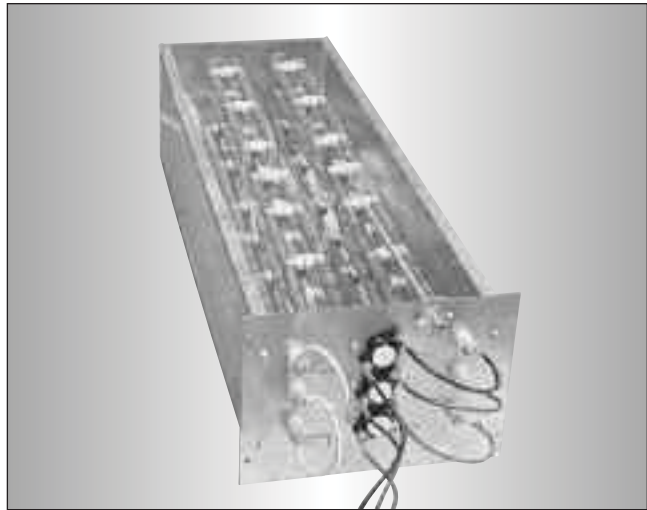

Time proportional control of the electric heater provides superior comfort and energy savings. The SCR controller modulates the heater to supply the exact amount of heat based upon the zone requirement. Room set points are maintained more accurately, undershoot and overshoot as associated with staged heat are eliminated, reducing operation costs.

SCR controllers provide silent operation, as mechanical staged contactors are eliminated. Zero cross switching of the thyristor prevents electrical noise.

Recommended Selection:

The table below is a quick reference guide, to illustrate the relationship between electrical power supply, heater capacity in kilowatts and terminal unit sizes that are available.

- Digital control terminals are available with up to 3 stages of heat. Analog electronic control terminals are available with 1 or 2 stages of heat only. A minimum of 1.0 kW per stage is required.
- Voltage and kilowatt ratings are sized so as not to exceed 48 amps, in order to avoid the NEC code requirement for circuit fusing.
- A minimum airflow of 70 cfm (33 l/s) per kW is required for any given terminal unit in order to avoid possible nuisance tripping of the thermal cut-outs.
- Discharge air temperature should not exceed 120°F (49°C).

Model Series	Unit Size	Electric Heat Maximum Kilowatts				
		208/240V 1Ph	277V 1 Ph	208V 3 Ph	480V 3 Ph	600V
38S	1	7	7	—	—	—
	3	8	11.5	13.5	16	16
	5	8	11.5	14.5	20.5	20.5

D UNDERFLOOR FAN POWERED TERMINAL UNITS

Electric Heating Coils • Application Guidelines

Discharge Air Temperature

When considering the capacity and airflow for the heater, discharge air temperature can be an important factor. Rooms use different types of diffusers, and they are intended to perform different functions. Slots that blend the air at the glass and set up air curtains within the room, must be able to blow the air very low in the room. Hot air will be too buoyant to be effective in this case. Discharge air temperatures for this application should be in the 85 – 90°F (29 – 32°C) range.

Diffusers in the center of the room blend their discharge air as it crosses the ceiling. Discharge air temperatures in this application can be as high as 105°F (41°C) and still be effective. However, if the return air grilles are in the discharge air pattern, the warm air will be returned to the plenum before it heats the room. Again, the air temperature needs to be blended down to an acceptable temperature that can be forced down into the occupied space by the time the air gets to the walls. Discharging warm air into the room at temperatures above 105°F (41°C) usually will set up stratification layers and will not keep the occupants warm if there is a ceiling return because only the top 12" – 24" (300 – 600 mm) of the room will be heated.

The maximum approved discharge air temperature for any Nailor Fan Powered VAV Terminal Unit with supplemental heat is 120°F (49°C). No heater should be applied to exceed this temperature.

Electric Heater Selection

To properly select an electric heater, three things must be determined: the heat requirement for the room, the entering air temperature and the desired discharge air temperature. The heat requirement for the room is the sum of the heat loss calculation and the amount of heat required to raise the entering air temperature to the desired room temperature. Usually, the second item is small compared to the first for fan powered terminal units in a return air plenum. Mbh can be converted to kW by using the chart or by calculation. There are 3413 Btus in 1 kW. If using the chart, find the Mbh on the left scale, then move horizontally to the right and read kW.

Next, the desired discharge air temperature should be ascertained. This will depend on the type of diffusers that are in the room.

The desired heating airflow for the room can then be calculated using the following equation:

$$cfm = \frac{kW \times 3160}{\Delta T \text{ (discharge air temp - inlet air temp.) } ^\circ F}$$

Assuming 70°F (21°C) supply air temperature to the heater, the room airflow can be selected directly from the chart. Start at the left at the design kW. Move horizontally to the desired discharge air temperature. Then, move vertically down to the cfm at the bottom of the chart.

The kW can be selected directly from the chart. Start at the bottom with the design cfm into the room. Move vertically up to the line that represents the desired discharge air temperature. Then, move left to the kW.

The discharge air temperature can also be selected directly from the chart. Start at the bottom with the design cfm into the room. Move to the left side of the chart and find the design kW. Move horizontally and vertically into the chart until the lines intersect. The intersection will be the desired discharge air temperature. Interpolation between the curves is linear.

Heater Selection Chart

Assuming 70°F inlet air temperature at heater.

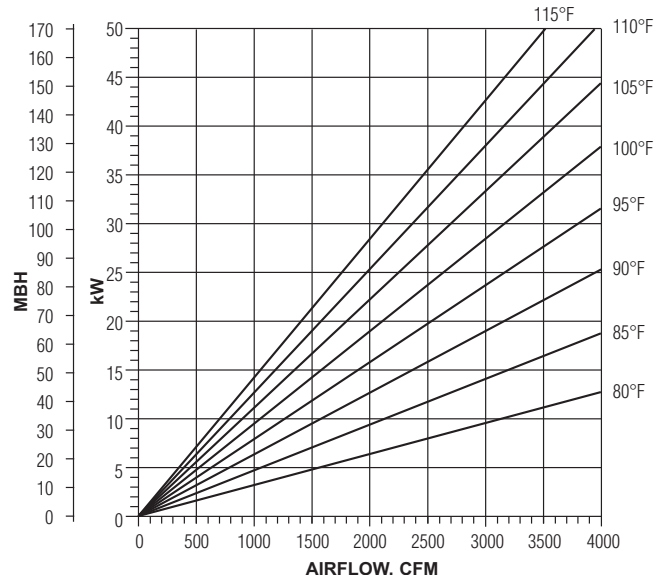

Diagonal lines are constant output temperature.

Controls • General Information

For a description of individual control components; see the controls overview section of the Nailor VAV Terminal Units Catalog.

Analog Electronic

The analog electronic controls provide pressure independent control. The components are matched and calibrated and provide regulated airflow in response to the electronic room thermostat, which is furnished as a part of the control package. Minimum and maximum airflow settings are adjusted at the thermostat, using a digital voltmeter. It is not necessary to adjust flow setting at the terminal in the ceiling space.

The new range of Nailor analog electronic controls utilize the 'Diamond Flow' multi-point averaging sensor as standard for accurate flow measurement.

The electronic thermostat has a fixed 2°F proportional band regardless of minimum or maximum velocity set points and provides a linear reset function. The thermostat has a built-in thermometer and set point indicator. The electronic controller/actuator features an on-board flow transducer.

Electric actuators are not spring return devices (there is no normally open or normally closed action). If there is a loss of power to the terminal, the damper will remain in the position it was in at the time of power failure. All electric components use low voltage (24 volt) controls. A step down transformer is provided as standard.

Direct Digital Controls

Nailor Industries Fan Powered Terminals are generic in nature and compatible with all DDC controls currently available.

Nailor can supply and mount its own 'Diamond Flow' multi-point averaging flow sensor.

Controls may be factory mounted and wired by **Nailor** or field installed by the controls contractor.

A 24 volt Class 2 control transformer and fan relay are provided by Nailor as standard on all fan powered terminals intended for use with digital controls.

Control Operation • Underfloor Fan Powered Terminal Units • Series Flow

Pressure Independent

Analog Electronic

Occupied Cycle

1. The series terminal fan is directly or indirectly interlocked and energized before or when the central system starts up.

Nailor recommends that the terminal fan is indirectly interlocked by means of an airflow switch (optional) which senses primary air pressure at the inlet. Upon central system start up, the fan in the terminal is automatically energized.

2. On a rise in room temperature, the thermostat sends a signal to increase the flow of cold primary air.

3. As more cold air is supplied to the fan section, less warm air is induced from the occupied space or underfloor plenum.

4. When the room temperature exceeds the set point by 2°F or more, cold airflow is maintained at the maximum setting. The maximum setting is the same as the total fan volume setting.

5. On a decrease in room temperature, the thermostat sends a signal to decrease the flow of cold primary air.

6. As less cold air is supplied to the fan section, more warm air is induced from the occupied space or underfloor plenum.

7. When the room temperature and thermostat output signal reach the thermostat set point, the cold airflow is at its minimum limit (usually zero) and the fan is supplying the maximum volume of induced air.

8. If room temperature continues to drop, an optional heating coil may be energized.

9. When the optional airflow switch is supplied, and the central system is turned off (night-time or weekend), the series terminal fan is shut down upon loss of primary air.

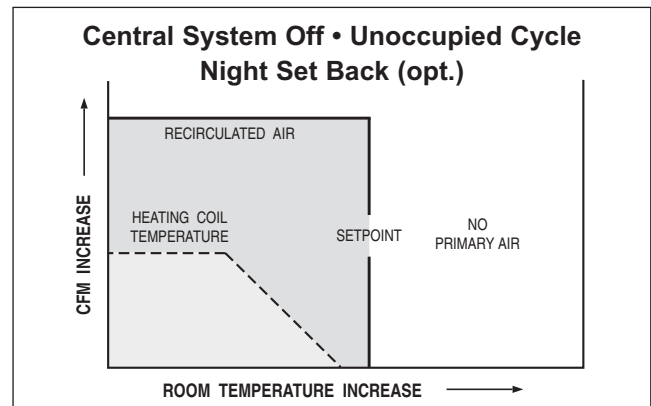
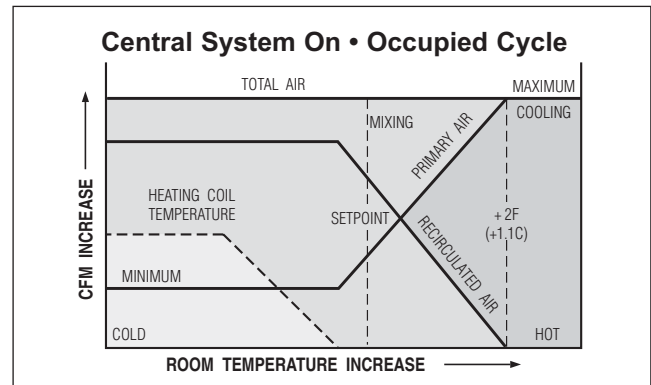

Optional Terminal Unit Liners For 'IAQ' Sensitive Applications

Nailor offers several options for terminal unit applications where the maintenance of an high Indoor Air Quality is a primary concern. Specific 'IAQ' liners are designed to address applications where the issue of fiberglass insulation eroding and entering the airstream is a concern and/or to reduce the risk of microbial growth.

The sound power levels published in this catalog for fan powered terminal units are based upon testing with standard dual density fiberglass insulation. Dual density insulation is surface treated to prevent erosion and was developed to optimize attenuation for terminal unit applications. Cataloged discharge sound levels for series terminals are not significantly affected by the different liner options, as the fan is mounted on the discharge, however radiated sound levels may escalate depending on the terminal model and liner selection. Contact your Nailor representative for further information.

Fiber-Free Liner

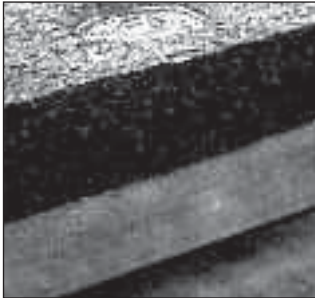

Fiber-Free liner.

Nailor's Fiber-Free liner is a closed cell elastomeric foam which totally eliminates fiberglass. It is 1/2" (13) thick. The liner has excellent thermal insulating characteristics. The foam does not absorb water, reducing the likelihood of mold or bacterial growth.

The Fiber-Free liner surface is smooth, so that dirt and debris won't accumulate, durable, erosion resistant and washable.

Complies with the following standards and tests:

- NFPA 90A Supplementary materials for air distribution systems.
- ASTM E84 and UL 181 (25/50) Smoke and Flame spread.
- ASTM C1071, G21, G22. No bacterial or fungal growth.
- Acoustical attenuation of radiated sound is reduced compared with standard dual density fiberglass insulation.

Steri-Liner

Steri-Liner is an internal insulation designed to reduce the risk of microbial growth within the terminal. A smooth non-porous facing provides a vapor barrier to moisture and reduces the risk of microorganisms becoming trapped. It also facilitates cleaning and prevents insulating material erosion. Damage to the liner though, will expose fiberglass particles to the airstream.

Acoustic absorption of aluminum foil lined insulation is reduced for discharge sound levels and essentially unchanged for radiated sound levels when compared to standard fiberglass insulation.

- It is 13/16" (21) thick, 4.1 lb./sq. ft. (66 kg/m³) density rigid fiberglass with a fire resistant reinforced aluminum foil-scrim-kraft (FSK) facing on all panels in the mixing chamber.
- Meets the requirements of NFPA 90A and UL 181 for smoke and flame spread and the bacteriological requirements of ASTM C665. Will not support the growth of fungi or bacteria.
- No exposed edges. All Steri-Liner panels feature full length steel angle inserts and end caps to encapsulate the edges.

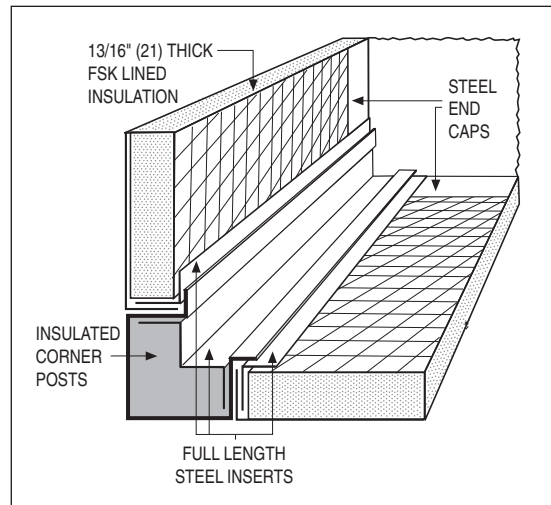

Steri-Liner detail on fan powered terminal unit.

Solid Metal Liner

Nailor also offers a solid inner metal liner that completely isolates the standard insulation from the airstream within the terminal mixing chamber. Solid metal liners offer the ultimate protection against exposure of fiberglass particles to the airstream, all but eliminating the possibility of punctures exposing fiberglass. This option is also resistant to moisture. The encased insulation still provides thermal resistance and radiated sound attenuation, but acoustic absorption of discharge sound is eliminated.

Fabricated as a box within a box to separate all surfaces and exposed edges of the insulation.

Perforated Metal Liner

Provides additional security and retains standard dual density fiberglass insulation or optional Steri-Liner insulation reducing possibility of long term erosion or breakdown.

Suggested Specifications • Underfloor Fan Powered Terminal Units • Model Series 38S

PART 1 – GENERAL

1.01 RELATED DOCUMENTS

A. The requirements of the general conditions, supplementary conditions, and the following specification sections apply to all work herein:

1. Section 15??? -- General.
2. Section 15??? -- Scope of Work.
3. Section 15??? -- Design Conditions.
4. Section 15??? -- Electric Motors and Controllers.
5. Section 15??? -- Access Doors and Color Coded Identification in General Construction.
6. Section 15??? -- Ductwork and Sheet Metal.
7. Section 15??? -- Testing, Balancing, and Adjusting.

1.02 SUMMARY

A. Furnish and install all air terminal units herein specified and as indicated on the drawings.

1.03 REFERENCE STANDARDS

A. All air terminal units shall be designed, manufactured, and tested in accordance with the latest applicable industry standards including the following:

1. ANSI/ASHRAE Standard 130-08.
2. AHRI Standard 880-08.
3. Underwriters Laboratories UL Standard 2009.
4. Underwriters Laboratories UL Standard 2009.

1.04 QUALITY ASSURANCE

A. All equipment and material to be furnished and installed on this project shall be UL or ETL listed, in accordance with the requirements of the authority having jurisdiction, and suitable for its intended use on this project. Space limitations shall be reviewed to ensure that the equipment will fit into the space allowed.

B. All equipment and material to be furnished and installed on this project shall be run tested at the factory and results of that testing shall be tabulated and provided to the engineer when the equipment ships to the job site. See paragraph 2.03 J for specific requirements.

C. All equipment and material to be furnished and installed on this project shall have been pre-tested in a mock-up facility suitable to the engineer. The test shall be as described in 2.03 D. The test results shall be supplied with the equipment submittal.

1.05 SUBMITTALS

A. The following submittal data shall be furnished according to the conditions of the construction contract, Division 1 specifications, and Section 15010 and shall include but not be limited to:

1. **Underfloor Fan Powered Variable Air Volume Terminal Units**, complete with capacity data, test data, construction details, physical dimensions, electrical characteristics, etc.

1.06 ACOUSTICS

Section A of this acoustical specification describes sound power levels as tested to AHRI 880 and ASHRAE 130. These are not the selection criteria for this specification. The selection criteria will be in section B where sound pressure readings are taken in an

actual mock-up that will exhibit worst case performance for the purpose of guaranteeing equipment performance when the building is commissioned and turned over to the occupant. Section A is important in that it provides a guideline for the minimum performance that the terminal units will have to meet in order to anticipate performance that will be acceptable under section B.

A. Sound Power Acoustical Performance:

1. **Discharge Noise:** Maximum permissible sound-power levels in octave bands of discharge sound through discharge ducts from terminal units operated at an inlet pressure of 0.1" w.g. and the maximum amount of air volume shown on the project mechanical drawings leaving the terminal unit and entering the reverberant chamber shall be as follows:

DISCHARGE SOUND POWER (dB re 10 ⁻¹² Watt)		
Octave Band	NC-35	NC-40
2	64	67
3	65	67
4	66	68
5	64	66
6	61	63
7	59	62

2. **Radiated Noise:** Maximum permissible radiated sound-power levels in octave bands of radiated transmission from terminal units operated at an inlet pressure of 0.1" w.g. and the maximum scheduled air quantity in an installed condition over occupied spaces shall be as follows:

RADIATED SOUND POWER (dB re 10 ⁻¹² Watt)		
Octave Band	NC-35	NC-40
2	64	68
3	56	61
4	49	54
5	48	53
6	47	52
7	51	56

B. Sound Pressure Acoustical Performance:

Each size of each terminal unit to be used on this project shall be completely laboratory tested for air performance and acoustics. Performance to NC 30, 35, 40 and 45 shall be charted for each size unit showing its maximum and minimum range limits under each NC condition listed above. If heater options change the overall performance, then the equipment shall be shown with electric and hot water coils in addition to no heat configurations. This data shall be submitted with the equipment submittal. Units that comply with the sound power data listed above may comply with the sound pressure performance. Testing is required to determine compliance and the performance range. Units that do not comply with the sound power performance in paragraph 1.06 A. probably will not comply with the sound pressure requirements or will have restricted ranges of acceptance.

1.07 WARRANTY

Manufacturer shall warrant equipment for one year.

D
UNDERFLOOR FAN POWERED TERMINAL UNITS

Suggested Specifications • Underfloor Fan Powered Terminal Units • Model Series 38S

PART 2 – PRODUCTS

2.01 UNAUTHORIZED MATERIALS

A. Materials and products required for the work of this section shall not contain asbestos, polychlorinated biphenyl's (PCB) or other hazardous materials identified by the engineer or owner.

2.02 ACCEPTABLE MANUFACTURERS

A. These specifications set forth the minimum requirements for underfloor fan powered VAV terminal units. If they comply with these specifications, underfloor fan powered VAV terminal units manufactured by one of the following manufacturers will be acceptable:

1. Nailor Industries.

2.03 VARIABLE PRIMARY AIR VOLUME FAN POWERED TERMINAL UNITS

A. Furnish and install underfloor fan powered VAV terminal units as indicated on the drawings. The units shall be designed and built as a single unit and provided with or without a primary variable air volume damper that controls the primary air quantity in response to a temperature control signal. The damper construction shall be rectangular with multiple opposed blades designed to operate on a 45° arc. Blades shall be heavy gauge galvanized steel, single thickness construction with heavy-duty gasket glued to the blades. Units shall be suitable for pressure independent control with [analog electronic or electronic DDC] controls. The units shall contain a fan and motor assembly and [electric or hot water] heating coils where scheduled and/or chilled water cooling coils where scheduled or indicated on the drawings. The fan shall provide a constant volume of discharge air at all air blending ratios from minimum to maximum scheduled primary air quantities and zero to 100% return airflow rates and shall be controlled in sequence as outlined hereinafter. The space limitations shall be reviewed carefully to ensure all terminal units will fit into the space provided including National Electric Code clearances required in front of all panels containing electrical devices. Units shall have removable access doors or panels of minimum 20 gauge galvanized steel on the top of the terminal unit that shall provide access to service the fan, electric motor and all internal components. Panels shall be attached with [screws or quick connect latches or hinges]. Unit shall be fully lined with at least 1/2" thick, dual density fiberglass insulation complying with NFPA 90 for fire and smoke resistivity and UL 181 for erosion. Any cut edges of insulation shall be coated with NFPA 90 approved sealant. Drain pans shall be of stainless steel construction and internally pitched to provide positive drain free performance. Casing leakage shall not exceed 2% of terminal rated airflow at 0.1" wg. interior casing pressure. Provide a filter rack with a 1" thick throwaway filter to be used during construction.

When scheduled, the terminal unit manufacturer shall provide flow curves for the primary air sensor clearly labeled and permanently attached on the bottom or side of each fan terminal.

The unit shall include all equipment and controls as required to provide a complete and operating system with at least the following equipment and controls:

1. Single point electrical connection for the voltage/phase as scheduled in the contract documents. See electrical drawings for power feeder arrangements. Motors shall be rated at [277 single phase or 120 single phase] as scheduled in the contract documents.
2. A toggle disconnect switch for cooling only units, or a door interlocking disconnect switch for terminal units with electric heating coils. All disconnecting devices shall be sized and located as required to disconnect all ungrounded power conductors to all

internal electrical components.

3. Individual overcurrent protection devices as required to protect individual units and transformers.

4. If there is a pressurized primary air source, the primary inlet shall be equipped with an inlet collar sized to fit the primary duct size shown on the drawings. Any transitions shall be provided and installed by the Division 15 mechanical subcontractor. The inlet collar shall provide at least a 6" length with a 1/8" high raised single or double bead located approximately 1 1/2" from the inlet connection. The primary and fan design cfm settings shall be clearly and permanently marked on the bottom of the unit along with the terminal unit identification numbers. Each terminal unit with a primary air inlet and damper shall incorporate a Nailor Diamond Flow sensor with four pick up points on each side to insure that with typical duct turbulence, the controller fidelity shall be +/- 5% of set volume even with a hard 90° elbow at the inlet. Static variation of 0.5" wg. to 6.0" wg. shall not affect the flow reading. Provide a transformer with 24 volt AC secondary to provide power for the unit's controls and the Division 17 controls. The VAV terminal unit manufacturer and the Division 17 building controls subcontractor shall verify compatibility of the multi-point flow sensors with transducer and DDC microprocessor furnished under Division 17 prior to bidding this project.

5. The outlets shall be rectangular or round as required. Unit shall be designed to fit between the floor pedestals with no bridging required.

6. Fan motor assembly shall be a forward curved centrifugal fan with a direct drive motor. Motors shall be AO Smith or General Electric ECM and/or Nailor EPIC variable-speed DC brushless motors specifically designed for use with a single phase, 120, 208, 240, 277 volt, 50 or 60 Hertz electrical input. Motor shall be complete with and operated by a single phase integrated controller/inverter that operates the wound stator and senses rotor position to electrically commutate the stator. All motors shall be designed for synchronous rotation. Motor rotor shall be permanent magnet type with near zero rotor losses. Motor shall have built-in soft start and slewed speed change ramps. Motor shall be able to be mounted with shaft in horizontal or vertical orientation. Motor shall be permanently lubricated with ball bearings. Motor shall be direct coupled to the blower. Motor shall maintain a minimum of 65% efficiency over its entire operating range. Provide isolation between fan motor assembly and unit casing in at least 4 locations to eliminate any vibration from the fan to the terminal unit casing. Provide isolation between the motor and blower as well as between the blower and casing. Provide anti-back rotation system or provide a motor that is designed to overcome reverse rotation and not affect life expectancy.

a. The manufacturer of the fan powered terminal units shall set the fan discharge cfm at the factory. If the fan powered terminal unit manufacturer cannot factory set the fan cfm, he shall send factory technicians to the field to adjust the GE ECM and/or Nailor EPIC motor and the associated controller/inverter to the discharge CFM indicated in the schedules in the contract documents. Fan cfm shall be constant within ± 5% regardless of changes in static upstream or downstream of the terminal unit after it is installed in the field. Fan cfm is to be set with a potentiometer and digital meter. Neither SCR's nor rheostats shall be an acceptable means of setting the fan cfm. The terminal unit manufacturer shall provide one speed adjustment device to the owner for field adjustment of the fan speed should construction or design changes become necessary.

D

UNDERFLOOR FAN POWERED TERMINAL UNITS

Suggested Specifications • Underfloor Fan Powered Terminal Units • Model Series 38S

PART 2 – PRODUCTS

b. A witnessed test shall be conducted by the fan powered terminal unit manufacturer in an independent testing laboratory to confirm that the terminal unit and the fan motor as an assembly performs in accordance with this specification. If the fan powered terminal unit and DC motor as an assembly fails to perform as specified and as scheduled on the drawings, the terminal unit manufacturer shall make adjustments and take all corrective action as necessary at the terminal unit manufacturer's sole expense.

7. The terminal unit shall be listed in accordance with UL 1995 as a composite assembly consisting of the terminal unit with or without the electric or hot water heating device and or chilled water cooling device.

8. Heating Options:

9. **If there is a pressurized primary air duct**, the terminal unit shall be capable of operation as described herein with inlet static pressure of .05 at full cooling with no mixing of induced and primary air. [The sequence of operation should be described here if not part of the temperature controls specifications.] The primary air damper shall be of a design that shall vary primary air supply in response to [a pneumatic or an electronic] signal. Primary air damper close-off leakage shall not exceed 2% of the maximum AHRI rated primary air cfm as shown in the manufacturer's catalog for each size terminal unit at 3" w.g. inlet static pressure. Submit damper leakage test data to the engineer for review. Damper linkage and actuator shall be located inside the terminal unit. Damper connection to the operating shaft shall be a positive mechanical through bolt connection to prevent any slippage. Provide non-lubricated Delrin or bronze oilite bearings for the damper shaft. The primary air damper in conjunction with the [pneumatic or analog electronic controller or DDC microprocessor] furnished under Division 17 shall be selected to provide accurate control at low primary air velocities. The total deviation in primary airflow shall not exceed $\pm 5\%$ of the primary air cfm corresponding to a 300 fpm air velocity through the primary air damper.

10. **If the unit incorporates a mixing chamber**, the mixing chamber shall provide mixing of primary air and plenum air from 100% primary air to 0% primary air. Mixing of the primary and secondary air streams shall be as described in paragraph 2.03 D. The deviation of fan supply air at design conditions and primary airflow rates from 100% primary air to 0% primary air shall not exceed 5%.

11. Provide duct inlet and outlet connections as indicated on the drawings.

12. All components, including all controls and wiring, shall be factory installed, except the room sensor or thermostat. No field assembly will be allowed. The unit shall be complete and suitable to accept the following field connections if required:

- a. Primary duct.
- b. Secondary duct.
- c. Single point electrical connection. See drawings for control box locations required for each terminal unit.
- d. DDC controller control signals and wiring.
- e. Room sensor connection.

B. The terminal unit shall be capable of operating throughout the full cataloged primary airflow range with an inlet static pressure of 0.10" w.g. or less. All downstream static pressure requirements are to be supplied by the terminal unit internal fan. See the schedules on the contract documents for static pressure requirements.

C. The control sequence shall be as specified in Division 17.

D. Each size of each terminal unit to be used on this project shall be completely laboratory tested for air performance and acoustics. The acceptability of the independent testing laboratory is subject to review by the owner, project acoustical consultant, and the engineer. The terminal unit manufacturer shall submit complete details, brochures, instrumentation information, etc., for review. The laboratory shall be capable of properly testing the largest terminal unit on this project. See paragraph 1.06 B for acoustic guidelines.

E. After the manufacturer has submitted certified copies of the laboratory air performance and acoustical performance test results to the engineer, the engineer may witness the laboratory tests to verify compliance with the Specifications. See Section 15???? for additional submittal and certification requirements.

I. All fan powered terminal units shall be identified on the top of the unit (minimum 1/2" high letters) and on the shipping carton, with the floor and box number that identifies it along with the CFM settings. Every unit shall have a unique number combination that matches numbers on the contractor's coordination drawings as to its location and capacity and is coordinated with the DDC controller and the Division 17 Building Control System submittal drawings.

J. The manufacturer will verify the operation of each unit before shipment. Testing shall include at least the following:

1. Apply electric power to the unit.
2. Start the fan and verify fan rotates properly.
3. The manufacturer shall factory or field adjust the GE ECM and/or Nailor EPIC motor and associated controller/inverter to the discharge CFM indicated in the schedules. (Refer to paragraph 2.03 A.2.e.1 hereinbefore.)
4. Energize the electric heat through the electric heating coil relay. Verify the signal with a voltmeter and ammeter to ensure proper heater operation.
5. De-energize the electric heating coil and verify the signal with a voltmeter to ensure the heater is de-energized.
6. If DDC controls are mounted, disconnect the primary air damper actuator from the DDC terminal unit controller. Provide separate power source to the actuator to verify operation and rotation of damper. Drive the damper closed and verify by feel or observation that damper is driven fully closed. Return primary air damper to the fully open position prior to shipment.
7. Provide a written inspection report for each terminal unit signed and dated by the factory test technician verifying all terminal unit wiring and testing has been performed per the manufacturer's testing and quality assurance requirements.

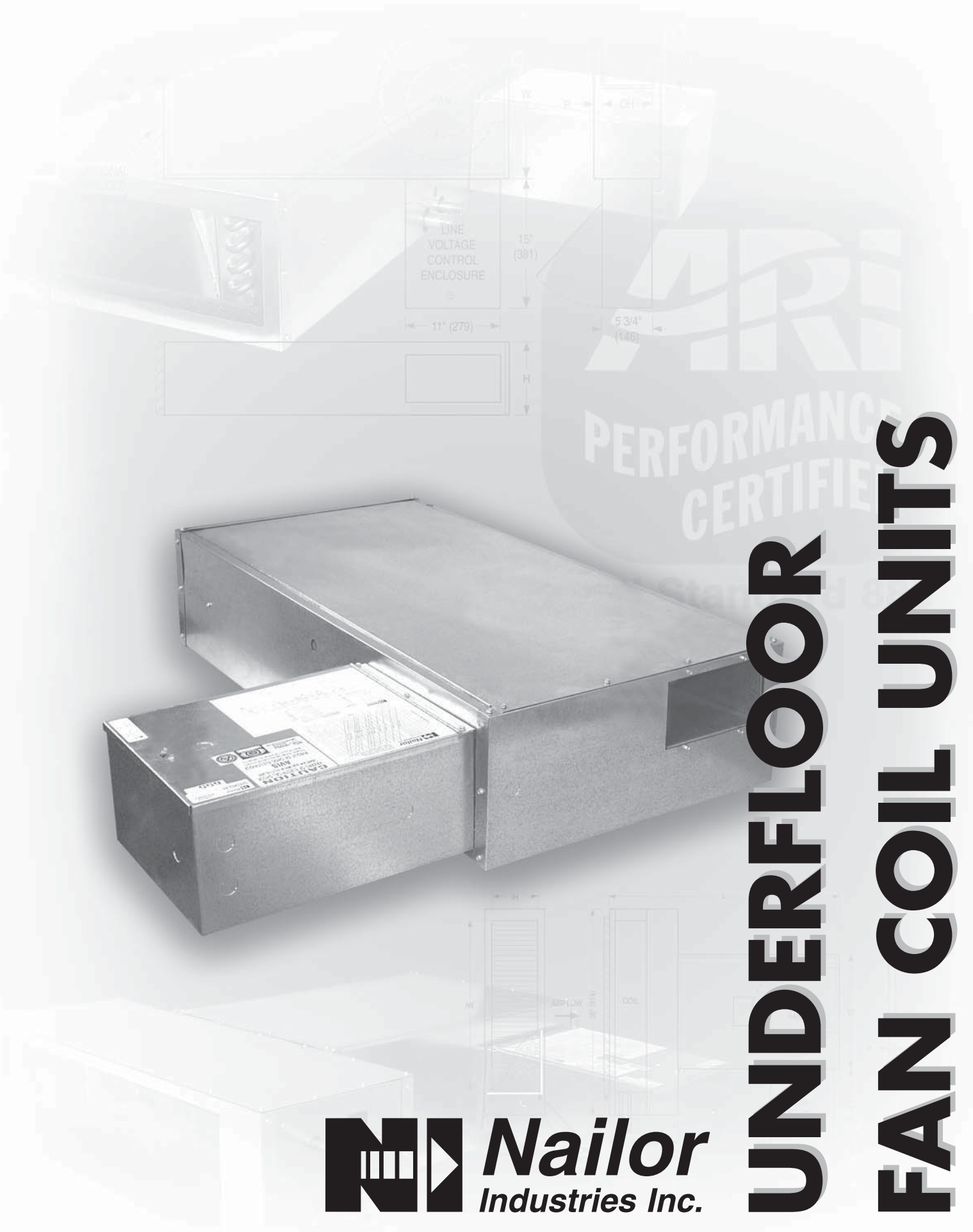

UNDERFLOOR FAN COIL UNITS

 **Nailor**
Industries Inc.

Contents

	Page No.
Underfloor Fan Coil Units	
Model 38F	
Features, Options, Accessories	E3
Dimensional Data	
Model 38F Fan Booster Unit, No Heat	E4
Model 38FZ, 38FW, 38FZW with Chilled Water and/or Hot Water Coil	E8
Model 38FE, 38FZE, 38FWE, 38FZWE w/Electric Heat, Chilled and/or Hot Water Coil	E11
Performance Data	
Fan Curves	E14
NC Level Application Guide/Sound Power Levels	E16
ARI Standard Ratings	E17
Water Coils	E18
Electric Heating Coils	E33
Optional Fan Coil Unit Liners for 'IAQ' Sensitive Applications	E35
Valve Packages	E36
Suggested Specifications	E39

UNDERFLOOR FAN COIL/ BOOSTER UNITS CONSTANT VOLUME 38F SERIES

Models:

- 38F** Fan Booster Units
- 38FE** Electric Heat
- 38FW** Hot Water Heat
- 38FWE** Hot Water/
Electric Heat
- 38FZ** Chilled Water
- 38FZW** Chilled/Hot Water
- 38FZE** Chilled Water/
Electric Heat
- 38FZWE** Chilled/Hot Water
and Electric Heat



Model 38F

The **Nailor Model Series 38F Underfloor Fan Coil/Booster Units** are specially engineered to meet the requirements of the most demanding underfloor applications where premium quality design and performance characteristics are desired. These compact low profile units feature excellent sound performance, independently tested and certified. Heavy gauge unit casings, designed to accommodate the floor pedestal layout, feature convenient access to all components.

Designed to optimize energy efficiency the standard units feature our ultra-high efficiency EPIC™/ECM motor technology. Additional options include two or four pipe water coils, electric heating coils, and various 'IAQ' linings including a solid metal liner.

STANDARD FEATURES:

- 20 ga. (1.0) galvanized steel construction.
- Full size top access panel.
- 1/2" (13) dual density insulation, exposed edges coated to prevent air erosion. Meets requirements of NFPA 90A and UL 181.
- Single point electrical connection.
- Discharge opening designed for flanged duct connection.
- Top access hinged door line voltage/fan controls enclosure.
- Controls mounted as standard on RH side as shown. Terminals ordered with LH controls (optional).
- Motor blower assembly mounted on special 16 ga. (1.6) angles and isolated from casing with rubber isolators.
- Ultra-energy efficient ECM fan motor with overload protection. Solid state Nailor EPIC™ fan volume controller.
- Controls are mounted on exterior of terminal providing ready access for field adjustment.
- Each terminal factory tested prior to shipment.
- Available with electric heat, hot water heat and chilled water cooling options.
- Stainless steel drain pans with primary and secondary (overflow) connections.
- Steri-liner.
- Fiber-free liner.
- Solid metal liner.
- Perforated metal liner.
- Fan unit fusing.
- Left-hand configuration.
- Factory assembled valve piping packages.
- Ultraviolet light packages.
- Nailor Thermostat.
- Safety overflow float switch.

OPTIONS AND ACCESSORIES:

- Filter frame and 1" (25) pleated/2" (51) disposable filter.
- Rubber support feet.
- Toggle disconnect switch.



ARI Standard 440



A Participating Corporation in the ARI 440 Certification program.

Underfloor Fan Booster Unit • ECM Motor

Models: 38F • Unit Sizes 1, 3 and 5

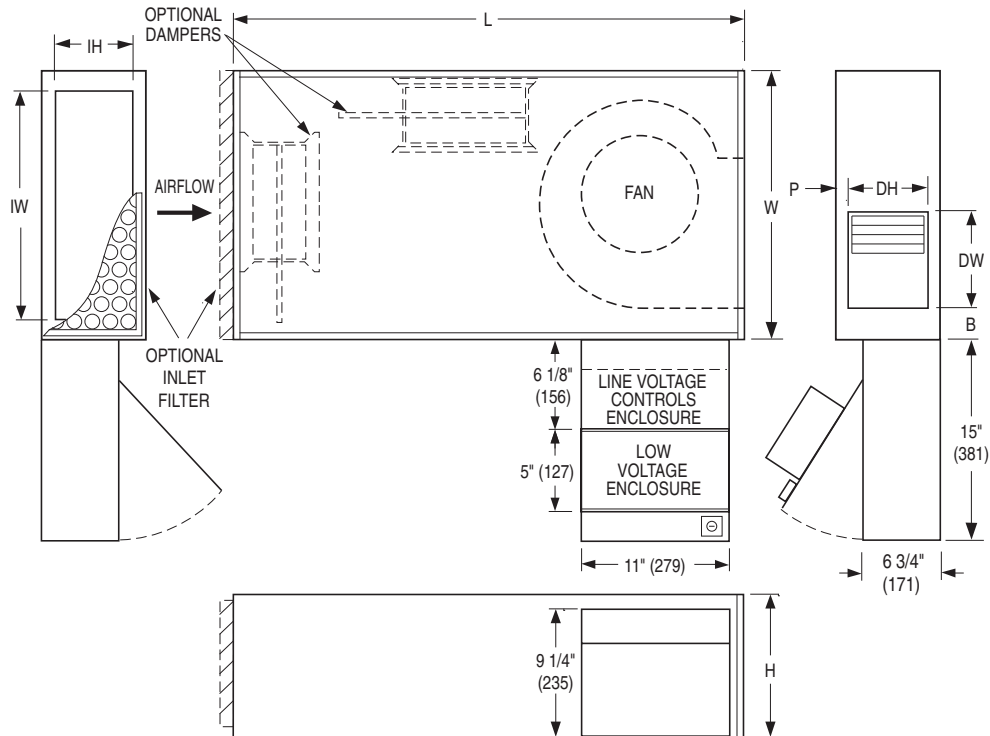

Dimensional Data. Imperial Units (inches)

Unit Size	W	H	L	B	P	Inlet IW x IH	Outlet Discharge DW x DH	Filter Size
1	20	8 1/2	40	2 3/8	29/32	17 x 5 3/4	7 3/16 x 5 15/16	19 x 7
3	20	11	40	4 3/8	1 1/2	17 x 8	12 1/4 x 8	19 x 10
5	20	15	44	1 1/4	2	17 x 12	13 1/4 x 11 1/2	20 x 15

Electrical Data

Unit Size	ECM Motor FLA			
	Voltage	120/1/60	208/240/1/60	277/1/60
1	Watts	277	276	270
	FLA	3.7	1.9	1.9
3	Watts	420	450	410
	FLA	5.8	3.4	2.9
5	Watts	930	1080	940
	FLA	12.6	6.2	5.5

FLA = Full load amperage

Dimensional Data. Metric Units (mm)

Unit Size	W	H	L	B	P	Inlet IW x IH	Outlet Discharge DW x DH	Filter Size
1	508	216	1016	60	23	432 x 146	183 x 151	483 x 178
3	508	279	1016	111	38	432 x 203	311 x 203	483 x 254
5	508	381	1118	32	51	432 x 305	337 x 292	508 x 381

UNDERFLOOR FAN COIL UNITS

E



ARI Standard 440



A Participating Corporation in the ARI 440 Certification program.

Underfloor Fan Booster Unit • ECM Motor

Models: 38F • Unit Size 2

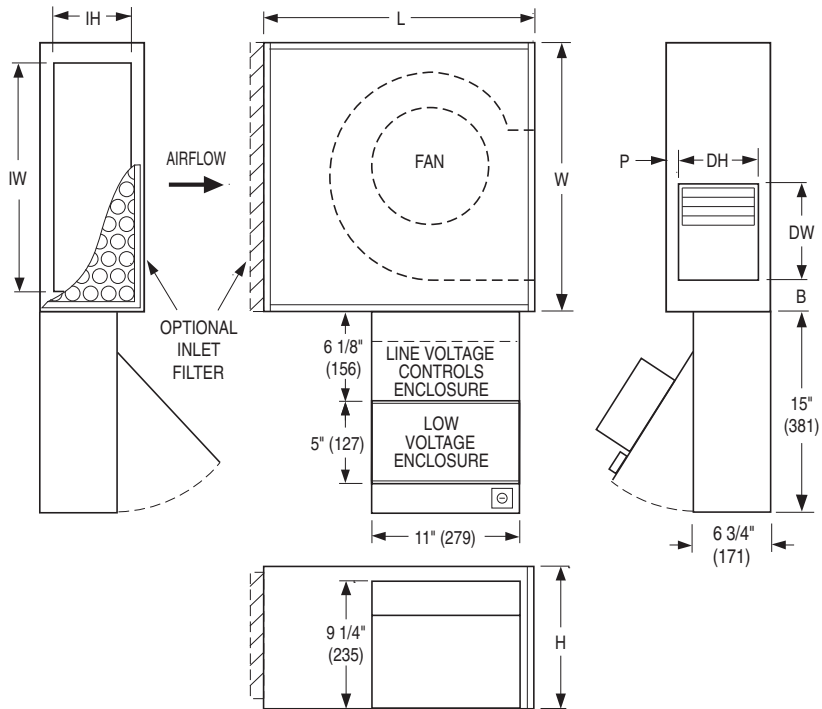

Dimensional Data. Imperial Units (inches)

Unit Size	W	H	L	B	P	Inlet IW x IH	Outlet Discharge DW x DH	Filter Size
2	20	11	20	4 3/8	1 1/2	17 x 8	12 1/4 x 8	19 x 10

Electrical Data

Unit Size	ECM Motor FLA			
	Voltage	120/1/60	208/240/1/60	277/1/60
2	Watts	410	400	430
	FLA	5.7	2.8	3.1

FLA = Full load amperage

Dimensional Data. Metric Units (mm)

Unit Size	W	H	L	B	P	Inlet IW x IH	Outlet Discharge DW x DH	Filter Size
2	508	279	508	111	38	432 x 203	311 x 203	483 x 254



ARI Standard 440



A Participating Corporation in the ARI 440 Certification program.

Underfloor Fan Booster Unit • ECM Motor

Models: 38F • Unit Size 6

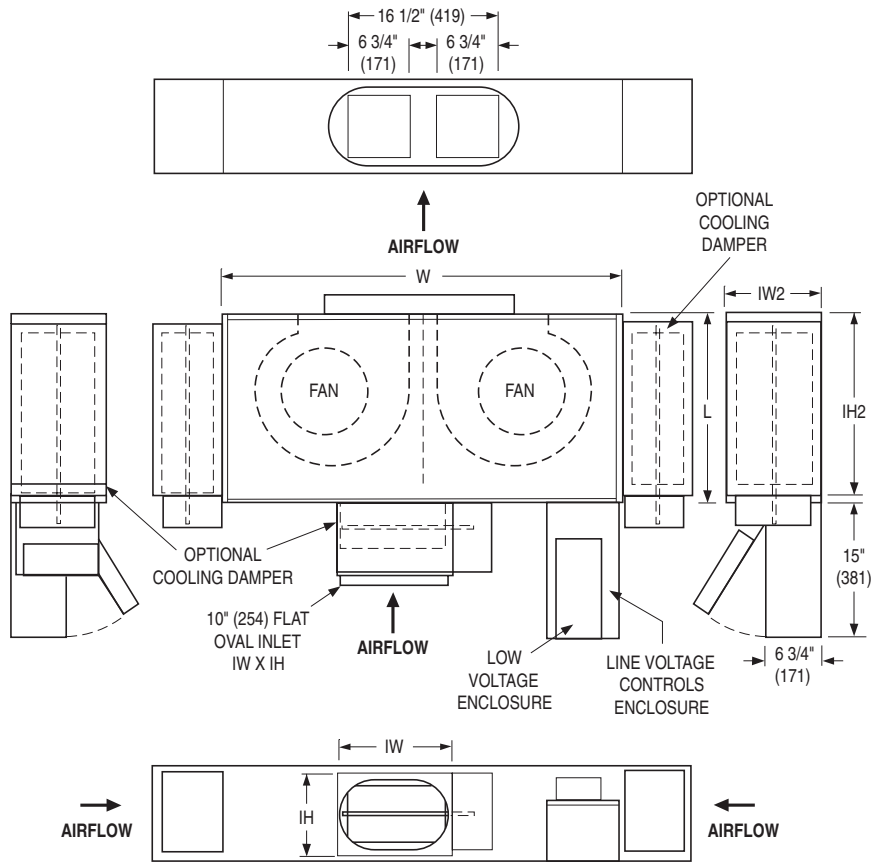

Dimensional Data. Imperial Units (inches)

Unit Size	W	H	L	Oval Inlet IW x IH	Rect. Inlet Discharge IW2 x IH2	Oval Outlet DW x DH
6	44	10 1/2	21	11 1/4 x 7 3/4	10 3/8 x 19	17 5/8 x 7 1/4

Electrical Data

Unit Size	ECM Motor FLA			
	Voltage	120/1/60	208/240/1/60	277/1/60
6	Watts	840	840	890
	FLA	10.2	5.3	5.9

FLA = Full load amperage

Dimensional Data. Metric Units (mm)

Unit Size	W	H	L	Oval Inlet IW x IH	Rect. Inlet Discharge IW2 x IH2	Oval Outlet DW x DH
6	1118	267	533	286 x 197	264 x 483	448 x 184



ARI Standard 440



A Participating Corporation in the ARI 440 Certification program.

Underfloor Fan Booster Unit • ECM Motor

Models: 38F • Unit Size 33

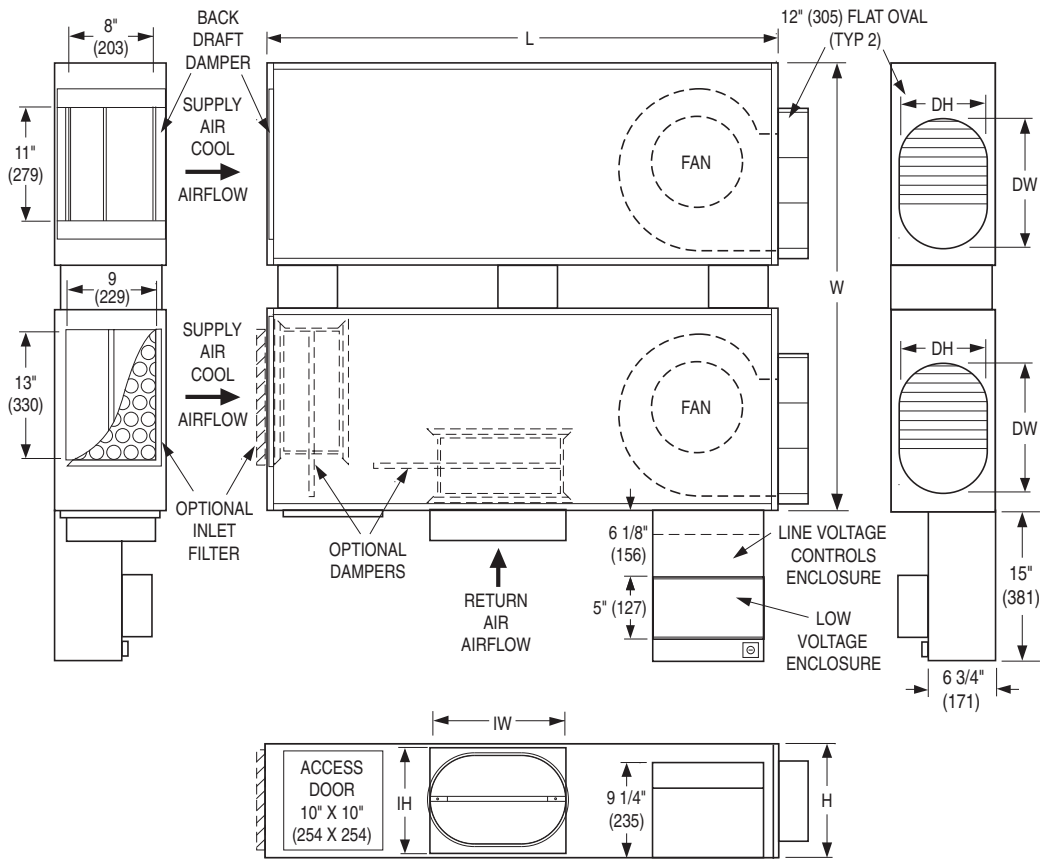

Dimensional Data. Imperial Units (inches)

Unit Size	W	H	L	Oval Ducted Inlet IW x IH	Oval Outlet Discharge DW x DH	Filter Size
33	44 15/16	11	50 15/16	14 1/4 x 7 3/4	7 3/16 x 5 15/16	11 x 15

Electrical Data

Unit Size	ECM Motor FLA			
	Voltage	120/1/60	208/240/1/60	277/1/60
33	Watts	840	900	820
	FLA	11.6	6.8	5.8

FLA = Full load amperage

Dimensional Data. Metric Units (mm)

Unit Size	W	H	L	Oval Ducted Inlet IW x IH	Oval Outlet Discharge DW x DH	Filter Size
33	1141	279	1294	362 x 197	183 x 151	279 x 381



ARI Standard 440



A Participating Corporation in the ARI 440 Certification program.

Underfloor Fan Coil Unit with Chilled Water and/or Hot Water Coil ECM Motor Models: 38FZ, 38FW, 38FZW • Unit Size 1

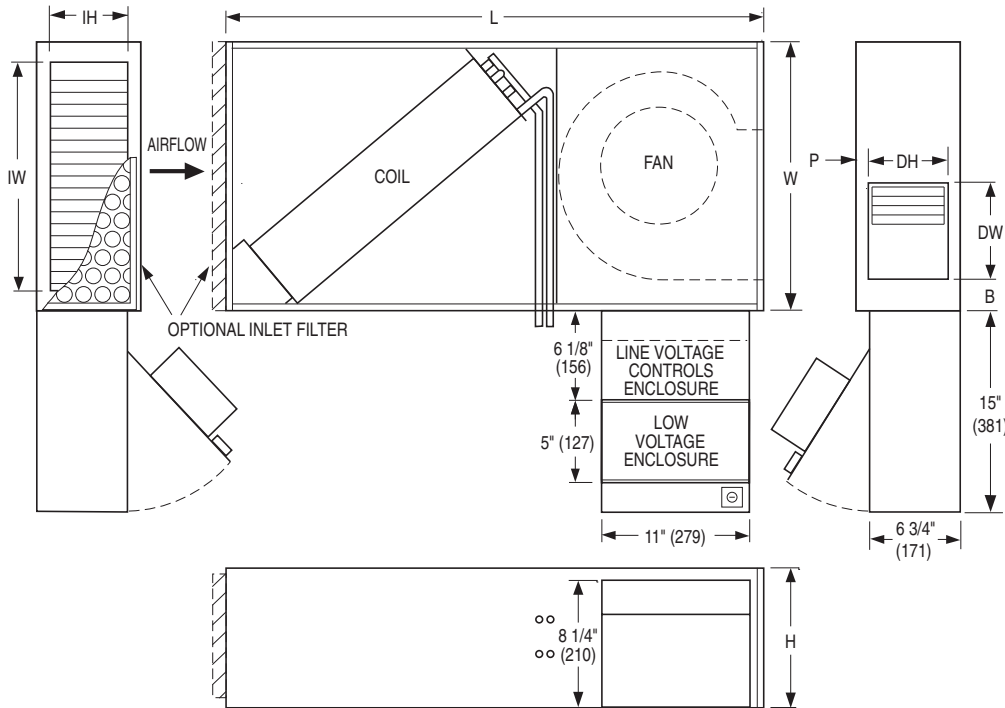

ARI Standard 440
A Participating Corporation
in the ARI 440
Certification program.



E

UNDERFLOOR FAN COIL UNITS

Dimensional Data. Imperial Units (inches)

Unit Size	W	H	L	B	P	Inlet IW x IH	Outlet Discharge DW x DH	Filter Size
1	20	8 1/2	40	2 3/8	29/32	17 x 5 3/4	7 3/16 x 4	19 x 7

Dimensional Data. Metric Units (mm)

Unit Size	W	H	L	B	P	Inlet IW x IH	Outlet Discharge DW x DH	Filter Size
1	508	216	1016	60	23	432 x 146	183 x 102	483 x 178

Electrical Data

Unit Size	ECM Motor FLA			
	Voltage	120/1/60	208/240/1/60	277/1/60
1	Watts	277	276	270
	FLA	3.7	1.9	1.9

FLA = Full load amperage

STANDARD FEATURES:

- 20 ga. (1.0) galvanized steel casing components.
- 1/2" (13) dual density insulation, exposed edges coated to prevent air erosion. Meets requirements of NFPA 90A and UL 181.
- 1/2" (13) copper tubed coil.
- Aluminum sine wave ripple fins.
- Units are only 8 1/2" (216) in height.
- Coil and header installed in insulated casing to increase thermal efficiency.
- Cooling coils include an insulated stainless steel drain pan with primary drain connection 3/4" (19) male NPT and secondary drain connection 1/2" (13) male NPT.

- Discharge opening designed for flanged outlet duct connection.
- Right hand coil connections (looking in direction of airflow) are standard. Left hand is optional. Controls enclosure is on same side as connections.
- Single point electrical connection.
- Top access panel.
- Sweat connections:
Heating Coils: One Row 1/2" (13) and Two Row 7/8" (22) O.D. male solder.
Cooling Coils: Three Row and Four Row 7/8" (22) O.D. male solder.

OPTIONS:

- Right hand (illustrated). Standard.
- Filter frame and 1" (25) pleated/2" (51) disposable filter.
- Factory assembled valve piping package.
- Ultraviolet light package.
- Perforated metal liner.
- Steri-liner.
- Left-hand configuration.
- Fan Unit fusing.
- Nailor Thermostat.
- Safety overflow float switch.
- Toggle disconnect switch.

Underfloor Fan Coil Unit with Chilled Water and/or Hot Water Coil ECM Motor Models: 38FZ, 38FW and 38FZW • Unit Sizes 3 and 5

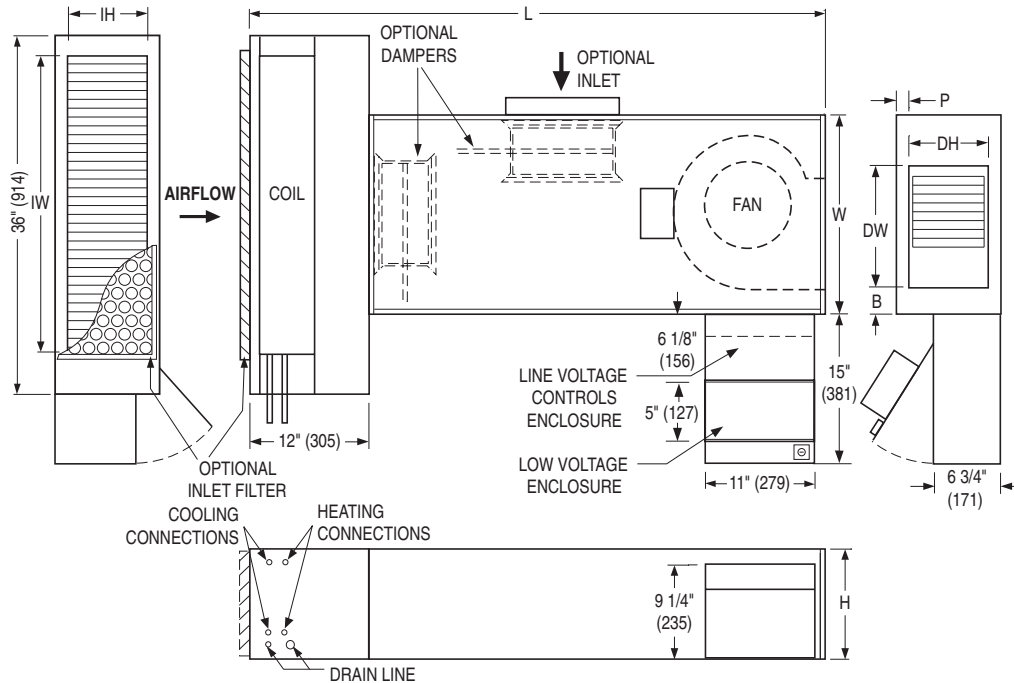

ARI Standard 440

A Participating Corporation in the ARI 440 Certification program.



Dimensional Data. Imperial Units (inches)

Unit Size	W	H	L	B	P	Inlet IW x IH	Outlet Discharge DW x DH	Filter Size
3	20	11	40 1/4	1	1 1/2	17 x 8	30 x 8	19 x 10
5	20	15	52	1 1/4	2	35 x 12	13 1/4 x 11 1/2	37 x 14

Dimensional Data. Metric Units (mm)

Unit Size	W	H	L	B	P	Inlet IW x IH	Outlet Discharge DW x DH	Filter Size
3	508	279	1022	25	38	432 x 203	762 x 203	483 x 254
5	508	381	1321	32	51	889 x 305	337 x 292	940 x 356

Electrical Data

Unit Size	ECM Motor FLA			
	Voltage	120/1/60	208/240/1/60	277/1/60
3	Watts	420	450	410
	FLA	5.8	3.4	2.9
5	Watts	930	1080	940
	FLA	12.6	6.2	5.5

FLA = Full load amperage

STANDARD FEATURES:

- 20 ga. (1.0) galvanized steel casing components.
- 1/2" (13) dual density insulation, exposed edges coated to prevent air erosion. Meets requirements of NFPA 90A and UL 181.
- 1/2" (13) copper tubed coil.
- Aluminum sine wave ripple fins.
- Coil and header installed in insulated casing to increase thermal efficiency.
- Cooling coils include an insulated stainless steel drain pan with primary drain connection 3/4" (19) male NPT and secondary drain connection 1/2" (13) male NPT.

- Discharge opening designed for flanged outlet duct connection.
- Right hand coil connections (looking in direction of airflow) are standard. Left hand is optional. Controls enclosure is on same side as connections.
- Single point electrical connection.
- Top access panel.
- Sweat connections:
Heating Coils: One Row 1/2" (13) and Two Row 7/8" (22) O.D. male solder.
Cooling Coils: Three Row and Four Row 7/8" (22) O.D. male solder.

OPTIONS:

- Right hand (illustrated). Standard.
- Filter frame and 1" (25) pleated/2" (51) disposable filter.
- Factory assembled valve piping package.
- Ultraviolet light package.
- Perforated metal liner.
- Steri-liner.
- Left-hand configuration.
- Fan Unit fusing.
- Nailor Thermostat.
- Safety overflow float switch.
- Toggle disconnect switch.

E

UNDERFLOOR FAN COIL UNITS

Underfloor Fan Coil Unit with Hot Water Coil • ECM Motor

Model: 38FW • Unit Size 33

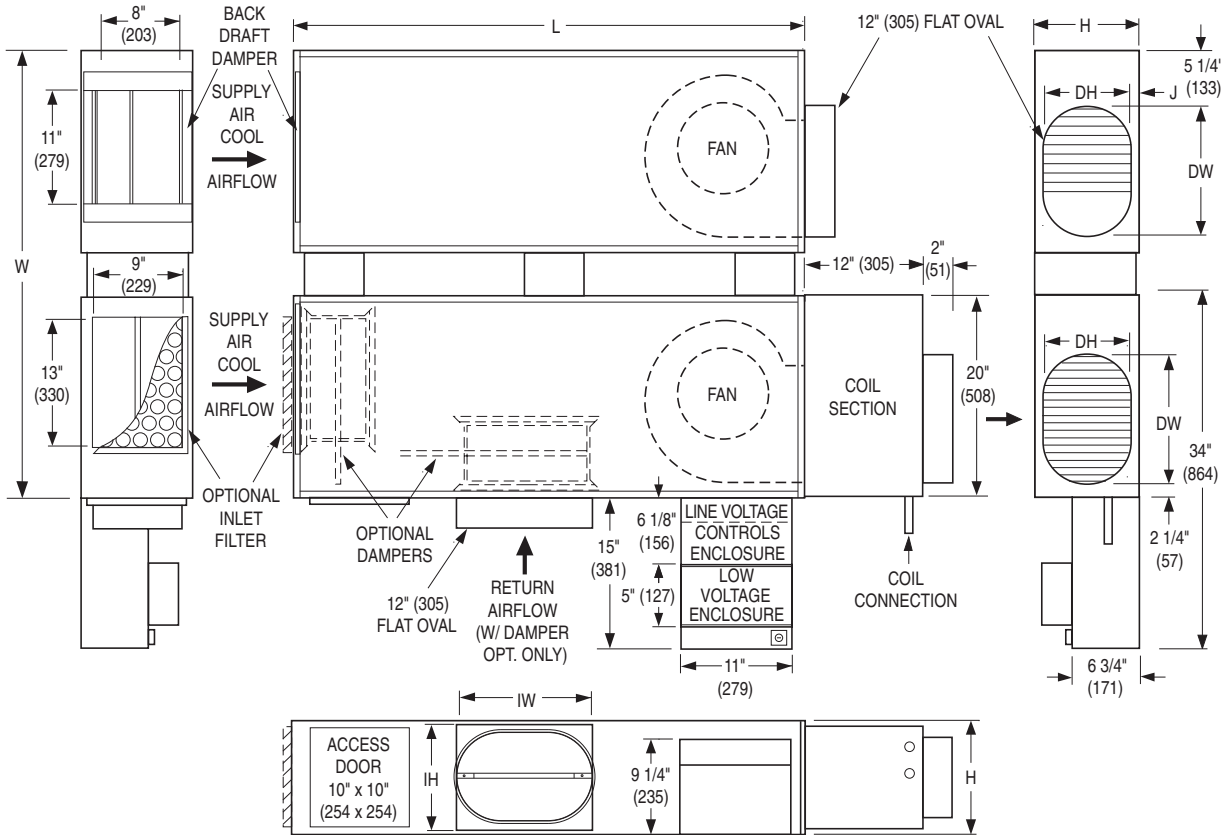

ARI Standard 440
A Participating Corporation in the ARI 440 Certification program.



UNDERFLOOR FAN COIL UNITS

Dimensional Data. Imperial Units (inches)

Unit Size	W	H	L	Oval Ducted Inlet IW x IH	Oval Outlet Discharge DW x DH	J	Filter Size
33	44 15/16	11	50 15/16	14 1/4 x 7 3/4	7 3/16 x 5 15/16	1 1/2	11 x 15

Electrical Data

Unit Size	ECM Motor FLA			
	Voltage	120/1/60	208/240/1/60	277/1/60
33	Watts	840	900	820
	FLA	11.6	6.8	5.8

FLA = Full load amperage

Dimensional Data. Metric Units (mm)

Unit Size	W	H	L	Oval Ducted Inlet IW x IH	Oval Outlet Discharge DW x DH	J	Filter Size
33	1141	279	1294	362 x 197	183 x 151	38	279 x 381

STANDARD FEATURES:

- High capacity units. Single fan on heating cycle (50% airflow).
- 20 ga. (1.0) galvanized steel casing components.
- 1/2" (13) dual density insulation, exposed edges coated to prevent air erosion. Meets requirements of NFPA 90A and UL 181.
- 1/2" (13) copper tubed coil.
- Aluminum sine wave ripple fins.
- Coil and header installed in insulated casing to increase thermal efficiency.
- Discharge opening designed for flanged outlet duct connection.

- Right hand coil connections (looking in direction of airflow) are standard. Left hand is optional. Controls enclosure is on same side as connections.
- Single point electrical connection.
- Top access panel.
- Sweat connections:
Heating Coils: One Row 1/2" (13) O.D. male solder. Two Row and Three Row and Four Row 7/8" (22) O.D. male solder.

Coil Rows:

- 1 Row • 2 Row • 3 Row

OPTIONS:

- Two 2 position supply/return inlet dampers.

- Filter frame and 1" (25) pleated/2" (51) disposable filter.
- Factory assembled valve piping package.
- Ultraviolet light package.
- Perforated metal liner.
- Steri-liner.
- Left-hand configuration.
- Fan Unit fusing.
- Nailor Thermostat.
- Safety overflow float switch.
- Toggle disconnect switch.

Underfloor Fan Coil Unit w/Electric Heat, Chilled and/or Hot Water + Electric Heat Models: 38FE, 38FZE, 38FWE, 38FZWE • Unit Sizes 1, 3 and 5

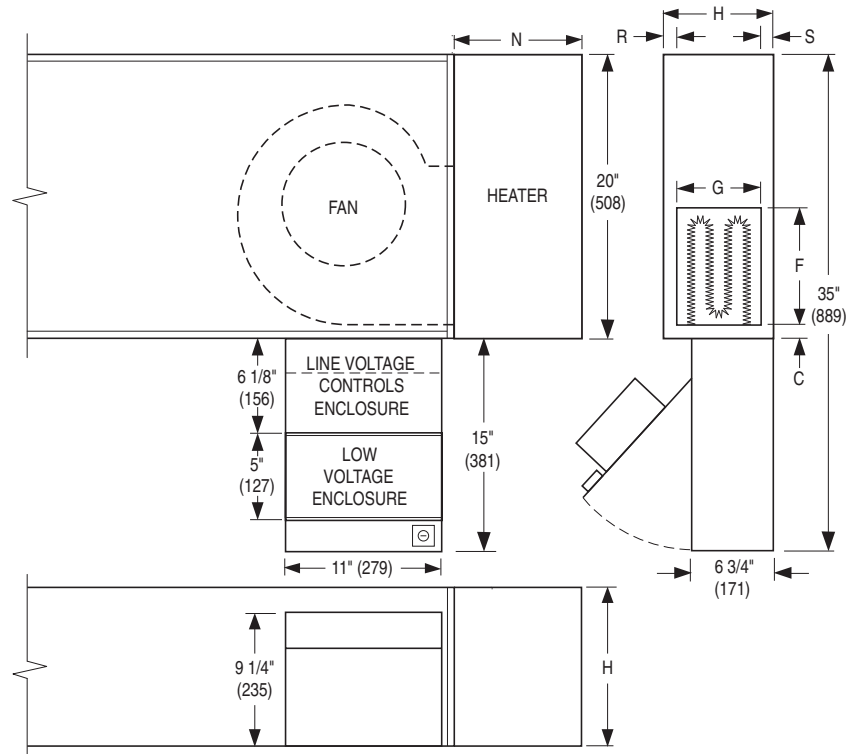

ARI Standard 440

A Participating Corporation in the ARI 440 Certification program.



E

UNDERFLOOR FAN COIL UNITS

Dimensional Data. Imperial Units (inches)

Unit Size	Outlet Discharge F x G	H	N	C	R	S	Filter Size
1	8 1/4 x 5 1/2	8 1/2	9	1 3/8	2	1	19 x 7
3	11 x 7 7/8	11	9	1	1 5/8	1 5/8	19 x 10/32 x 10 (w/Coil)
5	12 x 8 3/4	15	13 3/4	1	1	4	20 x 15

Dimensional Data. Metric Units (mm)

Unit Size	Outlet Discharge F x G	H	N	C	R	S	Filter Size
1	210 x 140	216	229	35	51	25	483 x 178
3	279 x 200	278	229	25	41	41	483 x 254/813 x 254 (w/Coil)
5	305 x 222	381	352	25	25	102	508 x 381

Electrical Data

Unit Size	ECM Motor FLA			
	Voltage	120/1/60	208/240/1/60	277/1/60
1	Watts	277	276	270
	FLA	3.7	1.9	1.9
3	Watts	420	450	410
	FLA	5.8	3.4	2.9
5	Watts	930	1080	940
	FLA	12.6	6.2	5.5

FLA = Full load amperage

STANDARD FEATURES:

- 20 ga. (1.0) galv. steel construction.
- Automatic reset high limit cut-outs (one per element).
- Controls enclosure incorporates a hinged access door opening upstream to help ensure NEC clearance and reduce footprint. FN2 (90° design) is standard.
- Controls mounted as standard on RHS as shown.
- Electric heater installed on unit discharge.
- Flanged outlet duct connection.
- Insulated heater element wrapper.
- Positive pressure airflow switch.

- Single point electric connection for the entire terminal unit.

- Terminal unit with heater is ETL listed as an assembly.

Standard Supply Voltage (60 Hz):

Single phase:

- 120V • 208V • 220V* • 240V
- 277V • 347V • 380V* • 480V
- 600V

Three phase - delta configuration:

- 208V • 220V* • 240V

Three phase - wye configuration:

- 380V* • 480V • 600V

(Three phase applies only on unit sizes 3 and 5).

* Outside of the U.S.

OPTIONS:

- Class 'A' 80/20 Ni./Cr. Wire.
- Door interlock disconnect switch.
- Dust tight construction.
- Left hand configuration.
- Manual reset secondary thermal cut-outs.
- Mercury contactors.
- Power circuit fusing.
- Toggle disconnect switch.

Underfloor Fan Coil Unit with Electric Heat only • ECM Motor Models: 38FE • Unit Size 6

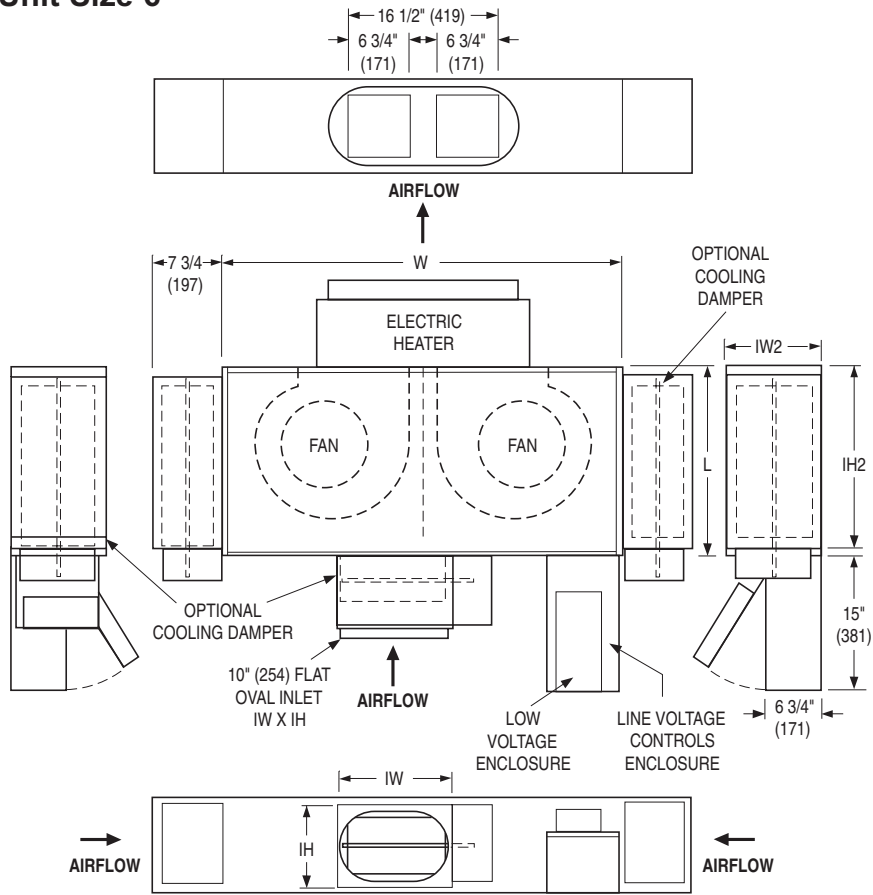

ARI Standard 440
A Participating Corporation in the ARI 440 Certification program.



UNDERFLOOR FAN COIL UNITS

Dimensional Data. Imperial Units (inches)

Unit Size	W	H	L	Oval Inlet IW x IH	Rect. Inlet Discharge IW2 x IH2	Oval Outlet DW x DH
6	55 5/16	11	21	14 1/4 x 7 3/4	10 x 15	17 5/8 x 7 3/4

Electrical Data

Unit Size	ECM Motor FLA			
	Voltage	120/1/60	208/240/1/60	277/1/60
6	Watts	840	840	890
	FLA	10.2	5.3	5.9

FLA = Full load amperage

Dimensional Data. Metric Units (mm)

Unit Size	W	H	L	Oval Inlet IW x IH	Rect. Inlet Discharge IW2 x IH2	Oval Outlet DW x DH
6	1405	279	533	362 x 197	254 x 381	448 x 184

STANDARD FEATURES:

- 20 ga. (1.0) galv. steel construction.
- Automatic reset high limit cut-outs (one per element).
- Controls enclosure incorporates a hinged access door opening upstream to help ensure NEC clearance and reduce footprint. FN2 (90° design) is standard, FN3 (remote) is an option.
- Controls mounted as standard on RHS as shown. Terminals ordered with LH controls (optional).
- Electric heater installed on unit discharge.

- Flanged outlet duct connection.
- Insulated heater element wrapper.
- Positive pressure airflow switch.
- Single point electric connection for the entire terminal unit.
- Terminal unit with heater is ETL listed as an assembly.

Standard Supply Voltage (60 Hz):

Single phase:

- 120V • 208V • 220V* • 240V
- 277V • 347V • 380V* • 480V
- 600V

Three phase - delta configuration:

- 208V • 220V* • 240V

Three phase - wye configuration:

- 380V* • 480V • 600V

* Outside of the U.S.

OPTIONS:

- Class 'A' 80/20 Ni./Cr. Wire.
- Door interlock disconnect switch.
- Dust tight construction.
- Left hand configuration.
- Manual reset secondary thermal cut-out.
- Mercury contactors.
- Power circuit fusing.
- Toggle disconnect switch.

Underfloor Fan Coil Unit with Electric Heat only • ECM Motor

Model: 38FE • Unit Size 33

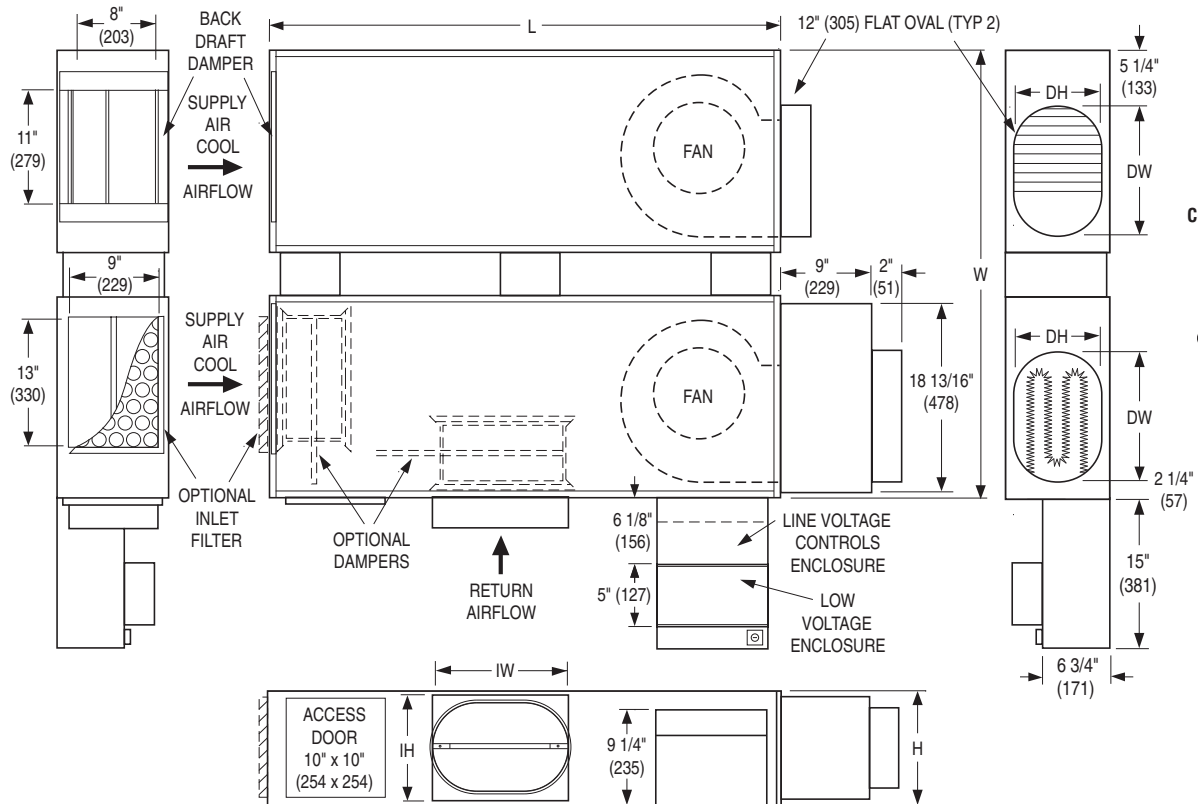

ARI Standard 440
A Participating Corporation in the ARI 440 Certification program.



E

UNDERFLOOR FAN COIL UNITS

Dimensional Data. Imperial Units (inches)

Unit Size	W	H	L	Oval Ducted Inlet IW x IH	Oval Outlet Discharge DW x DH	Filter Size
33	44 15/16	11	50 15/16	14 1/4 x 7 3/4	7 3/16 x 5 15/16	11 x 15

Electrical Data

Unit Size	ECM Motor FLA			
	Voltage	120/1/60	208/240/1/60	277/1/60
33	Watts	840	900	820
	FLA	11.6	6.8	5.8

FLA = Full load amperage

Dimensional Data. Metric Units (mm)

Unit Size	W	H	L	Oval Ducted Inlet IW x IH	Oval Outlet Discharge DW x DH	Filter Size
33	1141	279	1294	362 x 197	183 x 151	279 x 381

STANDARD FEATURES:

- 20 ga. (1.0) galvanized steel construction.
- Automatic reset high limit cut-outs (one per element).
- Controls enclosure incorporates a hinged access door opening upstream to help ensure NEC clearance and reduce footprint. FN2 (90° design) is standard.
- Controls mounted as standard on RHS as shown. Terminals ordered with LH controls (optional).
- Coil installed on unit discharge.
- Flanged outlet duct connection.

- Insulated coil element wrapper.
- Positive pressure airflow switch.
- Single point electric connection for the entire terminal unit.
- Terminal unit with coil is ETL listed as an assembly.

Standard Supply Voltage (60 Hz):

- Single phase:
- 120V • 208V • 220V* • 240V
 - 277V • 347V • 380V* • 480V
 - 600V
- Three phase - delta configuration:
- 208V • 220V* • 240V
- Three phase - wye configuration:
- 380V* • 480V • 600V
- * Outside of the U.S.

OPTIONS:

- Class 'A' 80/20 Ni./Cr. Wire.
- Door interlock disconnect switch.
- Dust tight construction.
- Left hand configuration.
- Manual reset secondary thermal cut-out.
- Mercury contactors.
- Power circuit fusing.
- Toggle disconnect switch.

Model Series 38F • Performance Data

EPIC ECM Motor Fan Curves - Airflow vs. Downstream Static Pressure

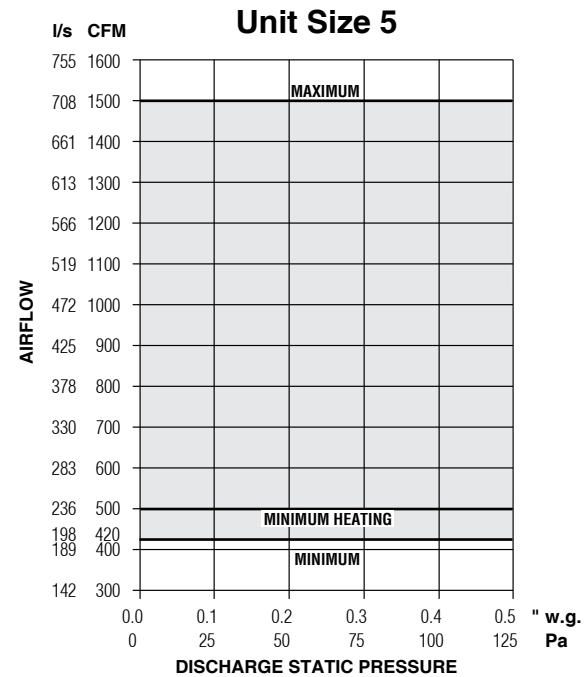
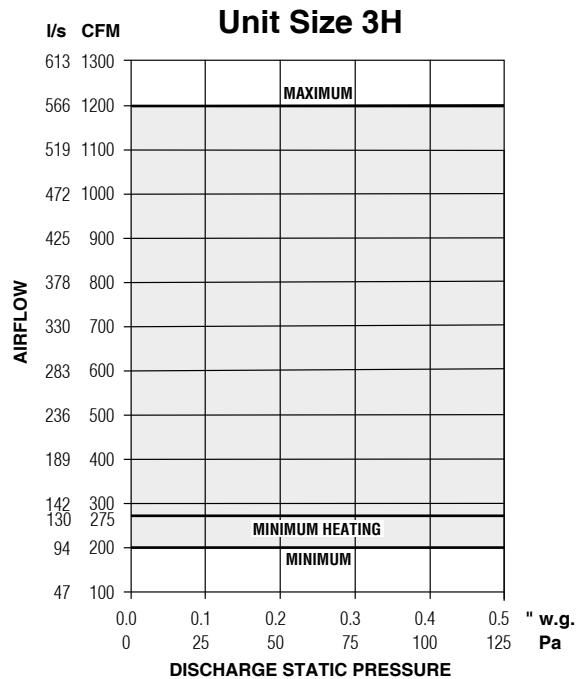
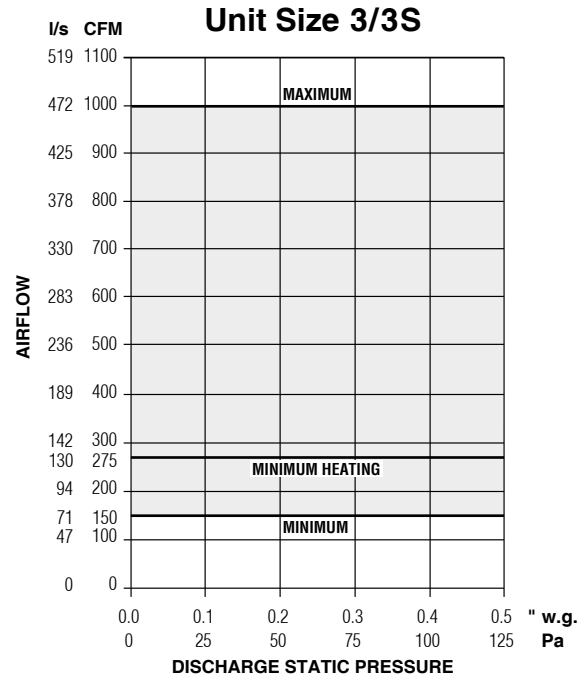
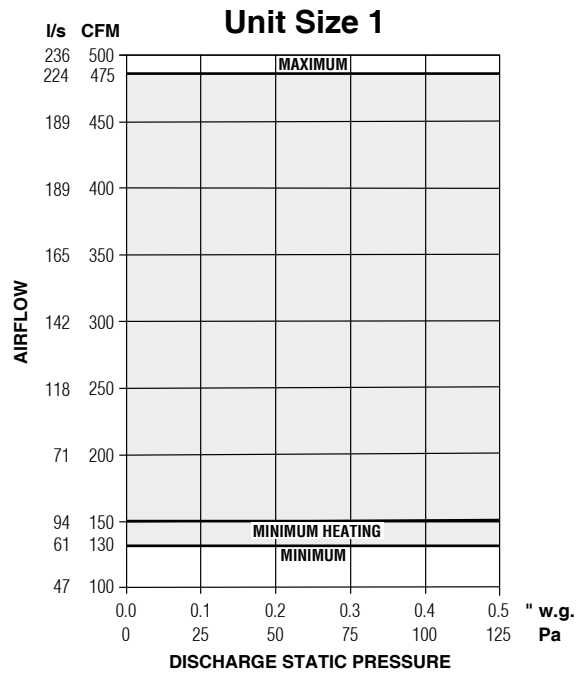

Electrical Data

Unit Size	Motor H.P.	EPIC ECM Motor FLA		
		120/1/60	208/240/1/60	277/1/60
1	*	3.7	1.9	1.9
3/3S	*	5.8	3.4	2.9
3H	*	6.3	4.0	3.7
5	*	12.6	6.2	5.5

* The EPIC ECM is a variable horsepower motor. Refer to Selectworks schedule for actual power consumption. FLA = Full load amperage. All motors are single phase/60 Hz.

NOTES:

- The ECM is pressure independent and constant volume in operation at factory or field set point within the shaded area. Airflow does not vary with changing static pressure conditions. The motor compensates for any changes in external static pressure or induced air conditions such as filter loading.
- Airflow can be set to operate on horizontal performance line at any point within shaded area using the solid state volume controller provided.
- Fan curves shown are applicable to 120, 208, 240 and 277 volt, single phase ECM's. ECM's, although DC in operation, include a built-in AC/DC converter.

UNDERFLOOR BOOSTER FAN POWERED TERMINAL UNITS

Model Series 38F • Performance Data

EPIC ECM Motor Fan Curves - Airflow vs. Downstream Static Pressure

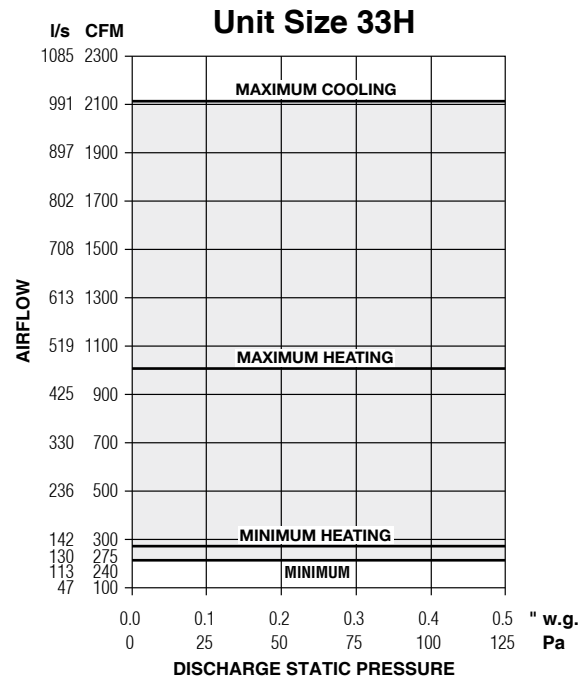
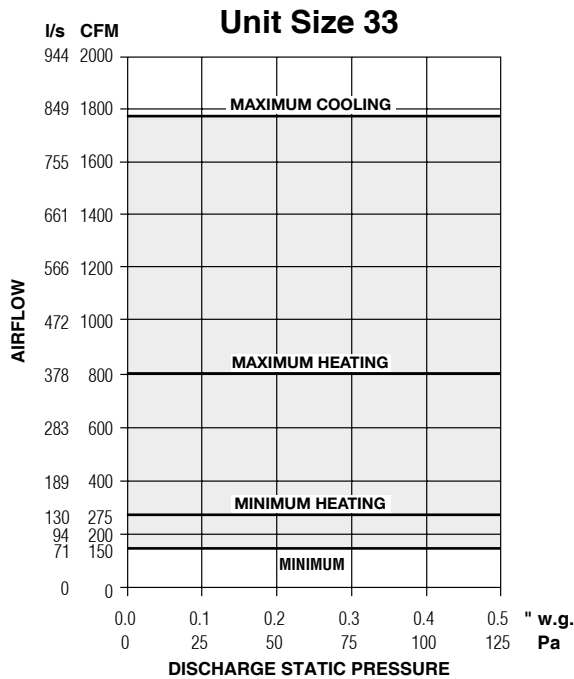
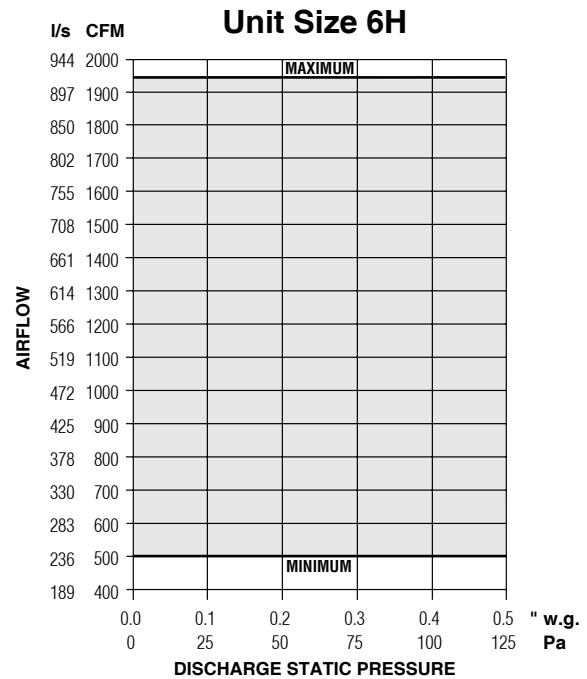
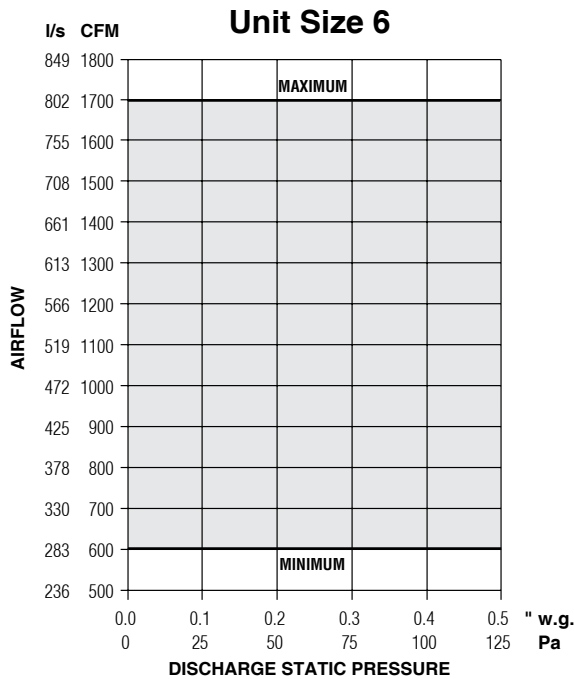

Notes: 33/33H Dual fan on cooling, single fan only heating.

Electrical Data

Unit Size	Motor H.P.	ECM Motor			
		Voltage	120/1/60	208/240/1/60	277/1/60
6	2 @ *	FLA	10.2	5.3	5.9
6H	2 @ *	FLA	12.6	6.5	6.8
33	2 @ *	FLA	11.6	6.8	5.8
33H	2 @ *	FLA	13.9	7.2	6.2

* The EPIC ECM is a variable horsepower motor.
Refer to Selectworks schedule for actual power consumption.
FLA = Full load amperage. All motors are single phase/60 Hz.

NOTES:

- The ECM is pressure independent and constant volume in operation at factory or field set point within the shaded area. Airflow does not vary with changing static pressure conditions. The motor compensates for any changes in external static pressure or induced air conditions such as filter loading.
- Airflow can be set to operate on horizontal performance line at any point within shaded area using the solid state volume controller provided.
- Fan curves shown are applicable to 120, 208, 240 and 277 volt, single phase ECM's. ECM's, although DC in operation, include a built-in AC/DC converter.

Model Series 38FZ • Performance Data

EPIC ECM Motor Fan Curves - Airflow vs. Downstream Static Pressure

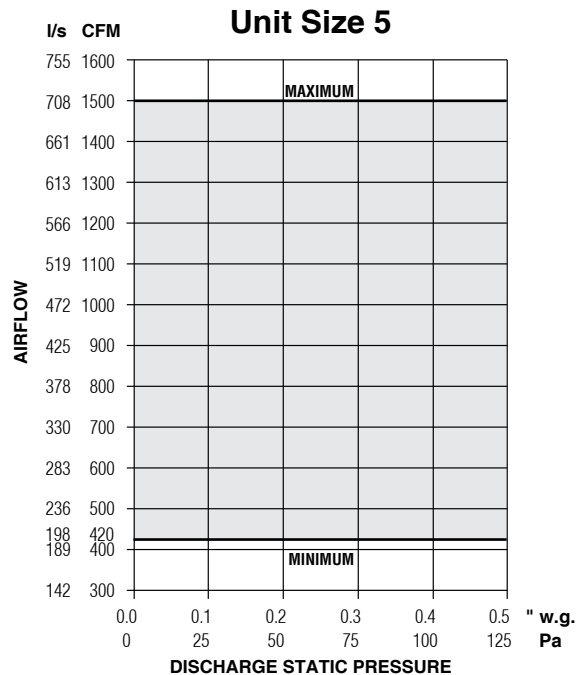
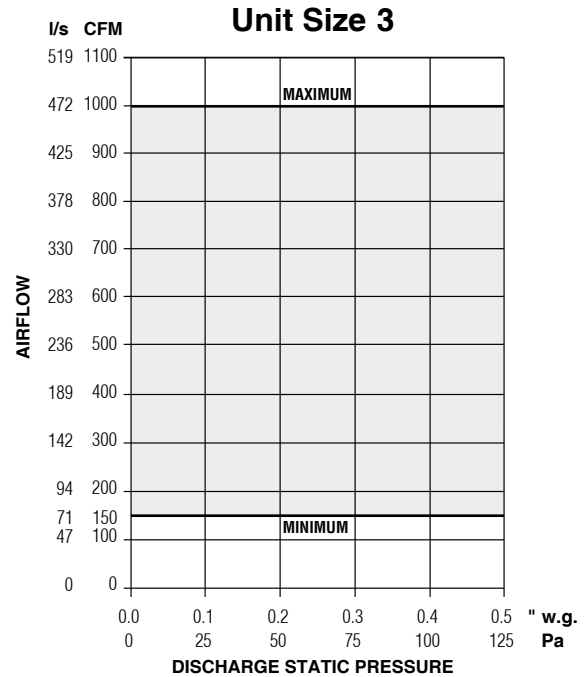
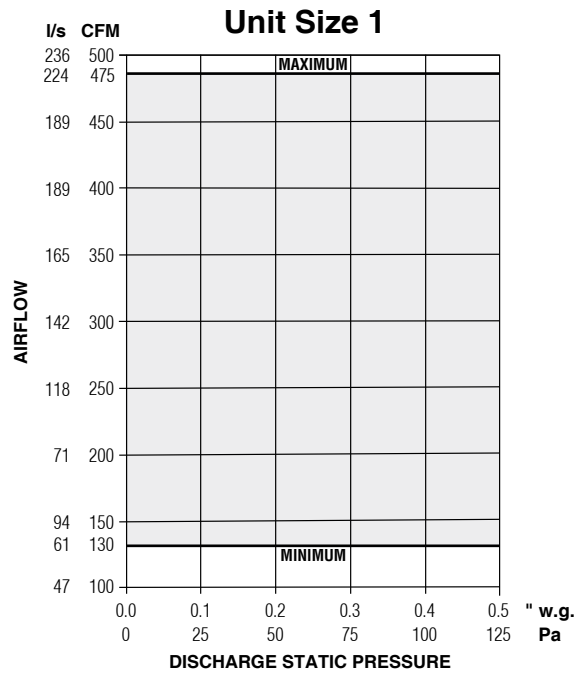

Electrical Data

Unit Size	Motor H.P.	EPIC ECM Motor FLA		
		120/1/60	208/240/1/60	277/1/60
1	*	3.7	1.9	1.9
3/3S	*	5.8	3.4	2.9
3H	*	6.3	4.0	3.7
5	*	12.6	6.2	5.5

* The EPIC ECM is a variable horsepower motor. Refer to Selectworks schedule for actual power consumption. FLA = Full load amperage. All motors are single phase/60 Hz.

NOTES:

- The ECM is pressure independent and constant volume in operation at factory or field set point within the shaded area. Airflow does not vary with changing static pressure conditions. The motor compensates for any changes in external static pressure or induced air conditions such as filter loading.
- Airflow can be set to operate on horizontal performance line at any point within shaded area using the solid state volume controller provided.
- Fan curves shown are applicable to 120, 208, 240 and 277 volt, single phase ECM's. ECM's, although DC in operation, include a built-in AC/DC converter.

UNDERFLOOR BOOSTER FAN POWERED TERMINAL UNITS

Model Series 38F • Underfloor Fan Coil/Booster Units • Performance Data NC Level Application Guide

Unit Size	Airflow cfm l/s		NC Levels	
			Octave Bands	
			Discharge	Radiated
1	450	212	34	34
	400	189	31	30
	300	142	22	24
	200	94	-	-
	110	52	-	-
3S	933	440	32	34
	800	378	26	30
	650	307	21	25
	500	236	-	20
	350	165	-	-
3	880	415	31	35
	700	330	24	25
	550	260	-	22
	400	189	-	-
	250	118	-	-
	150	71	-	-

Unit Size	Airflow cfm l/s		NC Levels	
			Octave Bands	
			Discharge	Radiated
5	1500	708	41	44
	1200	566	34	37
	900	425	27	28
	600	283	-	22
	300	142	-	-
6	1700	802	39	42
	1550	731	34	38
	1400	661	30	36
	1250	590	26	33
	1000	472	20	30
	850	401	-	26
	700	330	-	22
33	1760	831	35	39
	1400	661	26	30
	1100	519	-	25
	800	378	-	20
	500	236	-	-
	300	142	-	-

Discharge attenuation	Octave Band						
	2	3	4	5	6	7	
< 300 cfm	24	28	39	53	58	40	
300 – 700 cfm	27	29	40	51	53	39	
> 700 cfm	29	30	41	51	52	39	

3. Radiated sound attenuation deductions are based on an assumed effect of an access floor tile equal to 1/2" (13) gypsum board and environmental effect and are as follows:

Radiated attenuation	Octave Band						
	2	3	4	5	6	7	
Environmental effect	2	1	0	0	0	0	
Ceiling/Space effect	21	25	25	27	27	28	
Total dB Reduction	23	26	25	27	27	28	

4. Dash (-) in space denotes an NC level of less than 20.

Performance Notes:

1. NC levels are calculated from the published raw data and based on procedures outlined in Appendix E, ARI 885-98.

2. Discharge sound attenuation deductions are based on environmental effect, duct lining, branch power division, insulated flex duct, end reflection and space effect and are as follows:

Sound Power Levels

Unit Size	Airflow cfm l/s		Discharge Sound Power							Radiated Sound Power						
			Octave Bands							Octave Bands						
			2	3	4	5	6	7	2	3	4	5	6	7		
1	450	212	70	73	71	74	71	70	73	70	62	57	56	54		
	400	189	68	71	69	72	68	67	70	67	59	54	53	51		
	300	142	61	64	64	64	60	60	67	61	54	47	46	44		
	200	94	57	52	54	50	47	45	55	50	45	35	32	26		
	110	52	48	35	34	31	29	31	40	36	26	25	26	26		
3S	933	440	74	73	69	70	67	66	73	68	63	62	55	45		
	800	378	69	68	65	66	62	61	69	64	60	58	51	40		
	650	307	64	63	60	60	56	54	63	59	56	53	45	34		
	500	236	58	57	55	54	50	46	56	53	51	47	38	25		
	350	165	49	48	47	45	39	34	50	47	45	38	31	25		
3	880	415	73	72	68	70	67	66	75	68	62	57	52	52		
	700	330	67	65	63	64	60	59	68	63	57	52	46	46		
	550	260	60	58	57	58	54	51	63	57	53	47	40	38		
	400	189	53	52	51	50	45	41	59	52	48	40	36	33		
	250	118	54	45	43	40	35	32	59	46	40	34	31	30		
5	1500	708	84	79	77	79	78	77	82	74	68	64	59	56		
	1200	566	79	73	72	74	72	71	77	68	64	60	54	51		
	900	425	71	65	66	66	65	63	70	62	59	54	48	43		
	600	283	64	58	59	60	58	53	63	55	53	48	41	34		
	300	142	53	48	50	50	45	38	55	49	47	42	32	24		
6	1700	802	81	77	74	72	70	69	80	73	71	70	64	55		
	1550	731	78	74	71	68	66	65	76	69	67	66	59	49		
	1400	661	76	71	68	65	63	62	73	67	65	64	56	46		
	1250	590	72	68	65	62	59	58	70	64	63	61	53	43		
	1000	472	66	62	59	57	53	51	66	57	57	53	44	35		
	850	401	63	59	56	53	49	47	62	57	57	53	44	35		
	700	330	56	56	54	51	47	45	55	53	54	50	41	30		
33	1760	831	76	75	71	73	70	69	78	71	65	60	55	55		
	1400	661	70	68	66	67	63	62	71	66	60	55	49	49		
	1100	519	63	61	60	61	57	54	66	60	56	50	43	41		
	800	378	56	55	54	53	48	44	62	55	51	43	39	36		
	500	236	57	48	46	43	38	35	62	49	43	37	34	33		
	300	142	54	41	38	36	34	35	57	43	37	34	33	33		

Performance Notes:

1. Fan discharge (external) static pressure is 0.25" w.g. (63 Pa) in all cases. It is the difference (ΔP_s) in static pressure from fan coil unit discharge to the room.
2. Discharge sound power is the noise emitted from the unit discharge into the downstream duct.
3. Radiated sound power is the breakout noise transmitted through the unit casing walls.
4. Sound power levels are in decibels, dB re 10^{-12} watts.
5. All sound data listed by octave bands is raw data without any corrections for room absorption or duct attenuation.
6. Data derived from independent tests conducted in accordance with ARI Standard 880-98.

Model Series 38F • Underfloor Fan Coil/Booster Units • Performance Data ARI Standard Ratings

ARI STANDARD RATINGS									
Unit Size	COIL			AIRFLOW CFM (DRY BLOW)	COOLING CAPACITY		WATER		POWER INPUT (WATTS)
	Row	FPI	CIRC		QT (BTUH)	QS (BTUH)	FLOW RATE (GPM)	WPD ft-wg	
1	3	12	2	400	8835	7283	1.8	1	120
	4		2		10089	8191	2	0.6	122
2	N/A	N/A	N/A	930	N/A	N/A	N/A	N/A	320
3	3	12	2	700	14993	12468	3	1.2	270
	4		4		19673	15006	3.9	2.7	274
6	N/A	N/A	N/A	1700	N/A	N/A	N/A	N/A	890
*33	N/A	N/A	N/A	1680	N/A	N/A	N/A	N/A	640



ARI Standard 440

A Participating Corporation in the ARI 440 Certification program.

* In heating mode, the size 33 sound power levels are the same as the size 3 single only one fan is running.

NOTE: Based on 80°F DB and 67°F WB EAT, 45°F EWT 10° temperature rise, maximum fan speed. Motor type is ECM and motor voltage is 115/1/60. Airflow under dry conditions. Power consumption based on 0.0" static pressure.

Model Series 38F • Underfloor Fan Coil Units

Performance Data • Hot Water Coils • Unit Size 1

Data Based on 70°F DB Entering Air & 180°F Entering Water

1 Row (Total MBH)

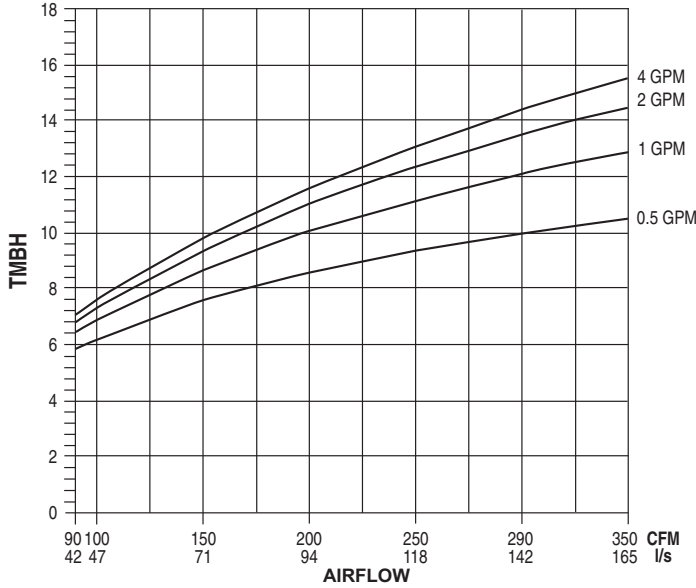

2 Row (Total MBH)

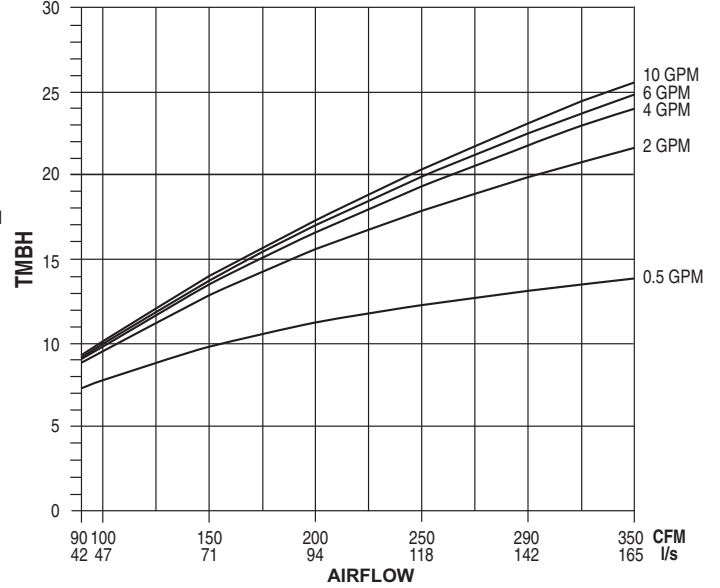

Notes:

- Capacities are in Mbh (thousands of Btu per hour).
- Mbh values are based on a ΔT (temperature difference) of 110°F between entering air and entering water. For other ΔT 's; multiply the Mbh values by the factors below.
- Air Temperature Rise. $ATR = 927 \times \frac{Mbh}{CFM}$
- Water Temp. Drop. $WTD = 2.04 \times \frac{Mbh}{GPM}$
- Connections: 1, 2 and 3 Row 7/8" (22); O.D. male solder.

Correction factors at other entering conditions:

ΔT °F	50	60	70	80	90	100	110	120	130	140	150
Factor	.455	.545	.636	.727	.818	.909	1.00	1.09	1.18	1.27	1.36

Altitude Correction Factors:

Altitude (ft.)	Sensible Heat Factor
0	1.00
2000	0.94
3000	0.90
4000	0.87
5000	0.84
6000	0.81
7000	0.78

Model Series 38F • Underfloor Fan Coil Units

Performance Data • Chilled Water Coils • Unit Size 1

Data Based on 65°F DB 59°F WB Entering Air & 45°F Entering Water

3 Row (Total MBH)

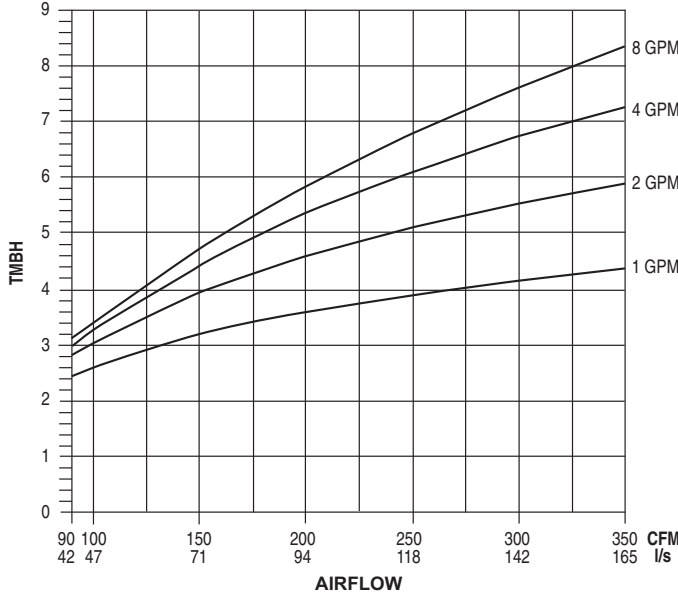

4 Row (Total MBH)

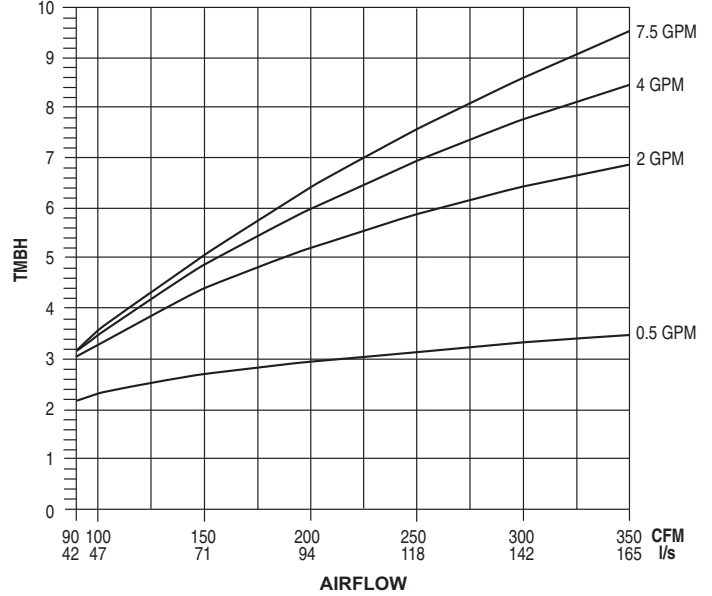

3 Row (Sensible MBH)

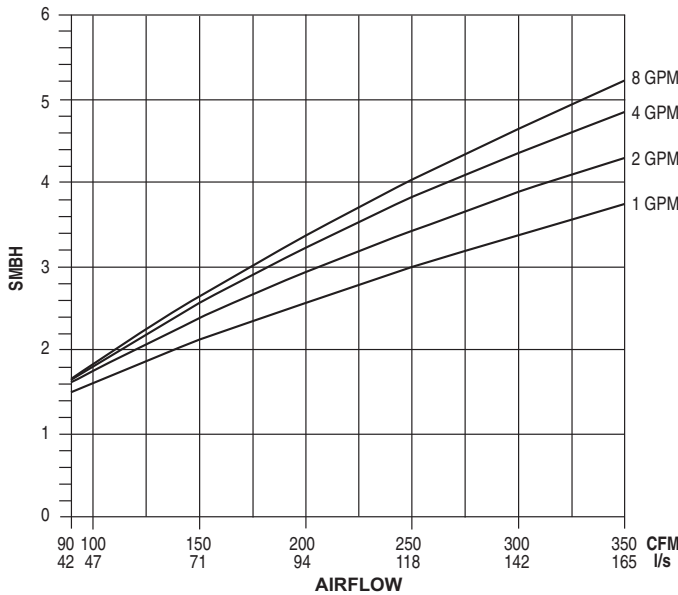

4 Row (Sensible MBH)

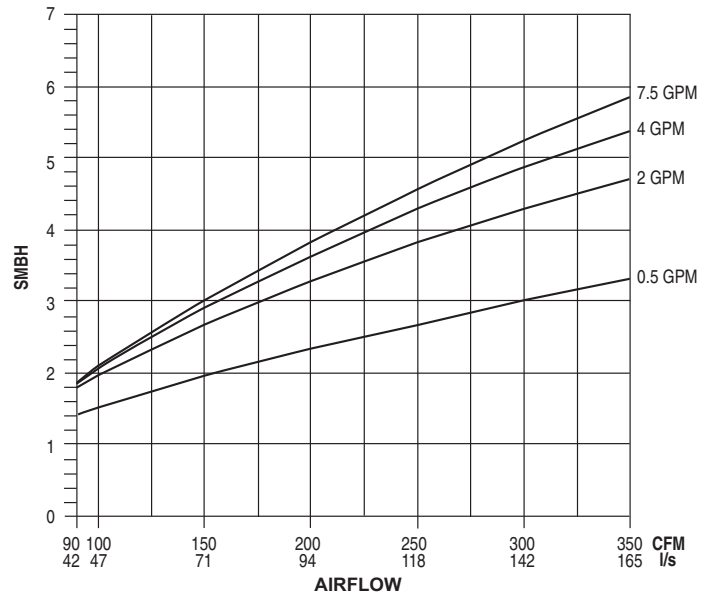

Altitude Correction Factors

Altitude (ft.)	0	1000	2000	3000	4000	5000	6000	7000
Air Density (lb./ft.3)	0.075	0.072	0.070	0.067	0.065	0.063	0.060	0.058
Total Capacity	1.000	0.988	0.986	0.983	0.981	0.979	0.977	0.975
Sensible Capacity	1.000	0.960	0.930	0.900	0.860	0.830	0.800	0.770
Static Pressure	1.000	0.960	0.930	0.900	0.860	0.830	0.800	0.770

Notes:

Capacity and static pressure will be affected for applications above sea level. To apply

correction factors, multiply factor by desired coil capacity or fan curve data.

Example: 38F Size XX with 3 row coil, high speed fan operation at 3000 ft. above sea level and with 0.1 inch. W.C. ESP.

Solution: Using correction factors from Altitude Correction chart for 3000 ft. above sea level, data from ARI Standard Ratings table and fan curves.

Total capacity = 12,500 BTUH (0.983) = 12,288 BTUH

Sensible Capacity = 8,000 BTUH (0.90) = 7,200 BTUH

SP = 0.1 (0.90) = 0.09 Inch W.C.

E

UNDERFLOOR FAN COIL UNITS

Model Series 38F • Underfloor Fan Coil Units

Performance Data • Chilled Water Coils • Unit Size 1

Data Based on 65°F DB 59°F WB Entering Air & 45°F Entering Water

5 Row (Total MBH)

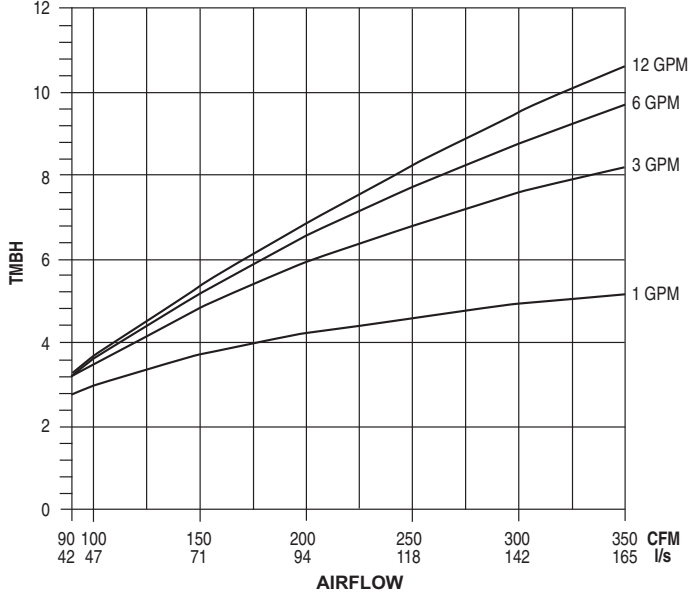

6 Row (Total MBH)

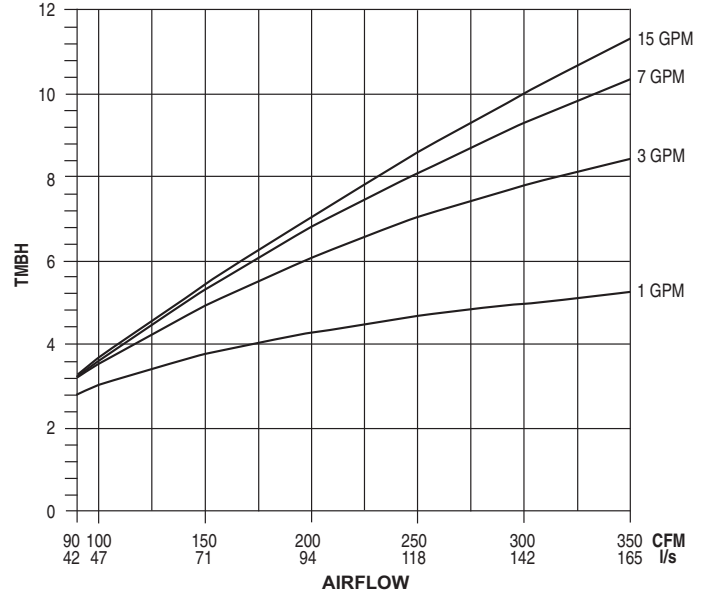

5 Row (Sensible MBH)

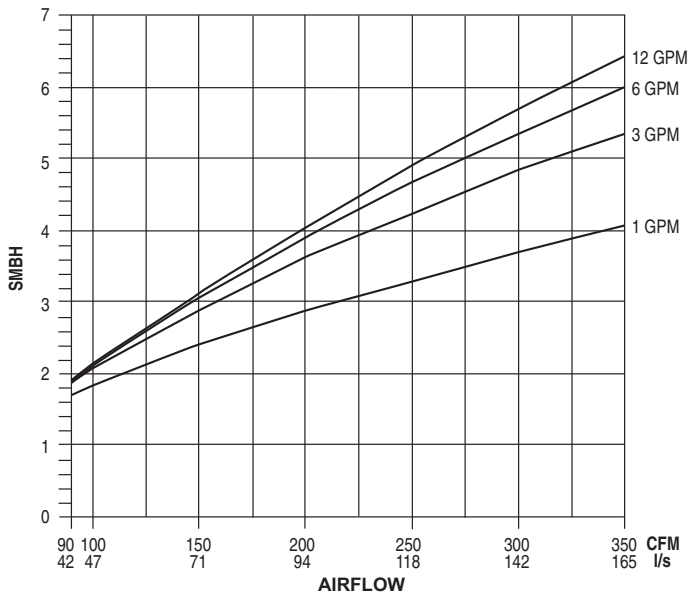

6 Row (Sensible MBH)

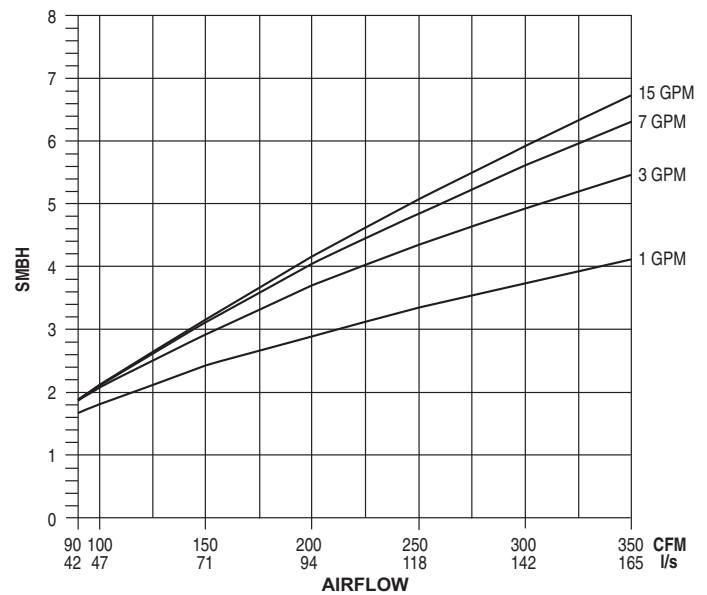

Altitude Correction Factors

Altitude (ft.)	0	1000	2000	3000	4000	5000	6000	7000
Air Density (lb./ft.3)	0.075	0.072	0.070	0.067	0.065	0.063	0.060	0.058
Total Capacity	1.000	0.988	0.986	0.983	0.981	0.979	0.977	0.975
Sensible Capacity	1.000	0.960	0.930	0.900	0.860	0.830	0.800	0.770
Static Pressure	1.000	0.960	0.930	0.900	0.860	0.830	0.800	0.770

Notes:

Capacity and static pressure will be affected for applications above sea level. To apply

correction factors, multiply factor by desired coil capacity or fan curve data.

Example: 38F Size XX with 3 row coil, high speed fan operation at 3000 ft. above sea level and with 0.1 inch. W.C. ESP.

Solution: Using correction factors from Altitude Correction chart for 3000 ft. above sea level, data from ARI Standard Ratings table and fan curves.

Total capacity = 12,500 BTUH (0.983) = 12,288 BTUH

Sensible Capacity = 8,000 BTUH (0.90) = 7,200 BTUH

SP = 0.1 (0.90) = 0.09 Inch W.C.



UNDERFLOOR FAN COIL UNITS

Model Series 38F • Underfloor Fan Coil Units

Performance Data • Chilled Water Coils • Unit Size 1

Data Based on 80°F DB 67°F WB Entering Air & 45°F Entering Water

3 Row (Total MBH)

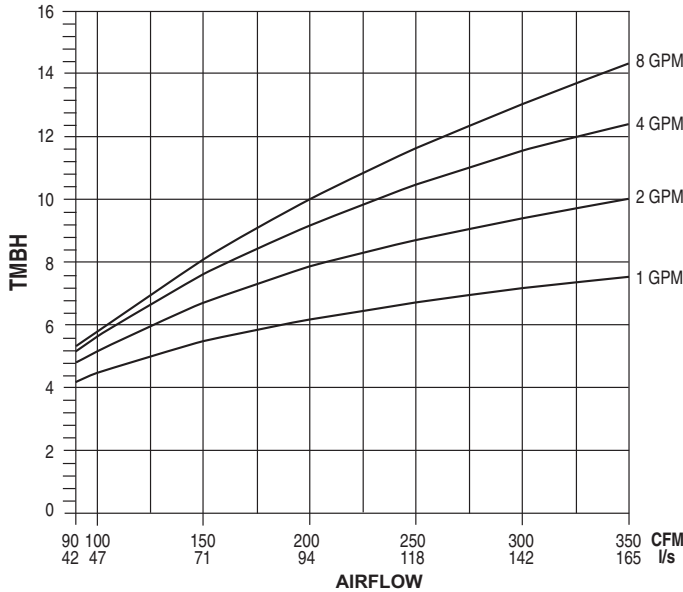

4 Row (Total MBH)

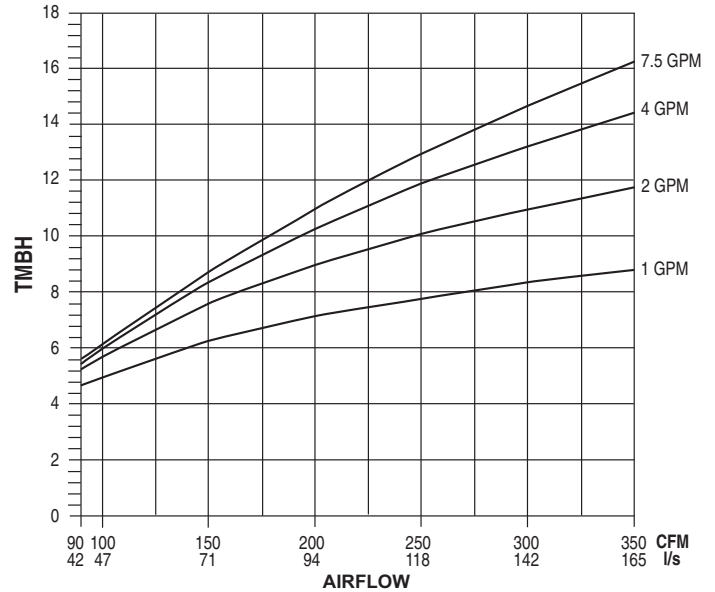

3 Row (Sensible MBH)

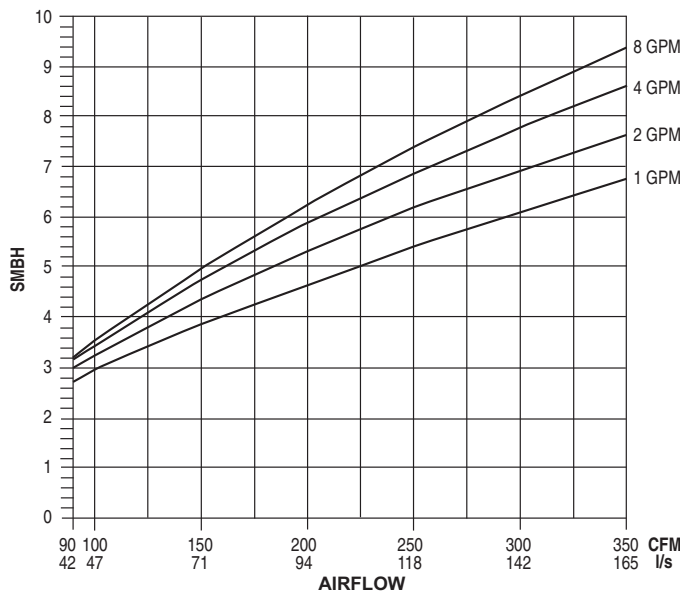

4 Row (Sensible MBH)

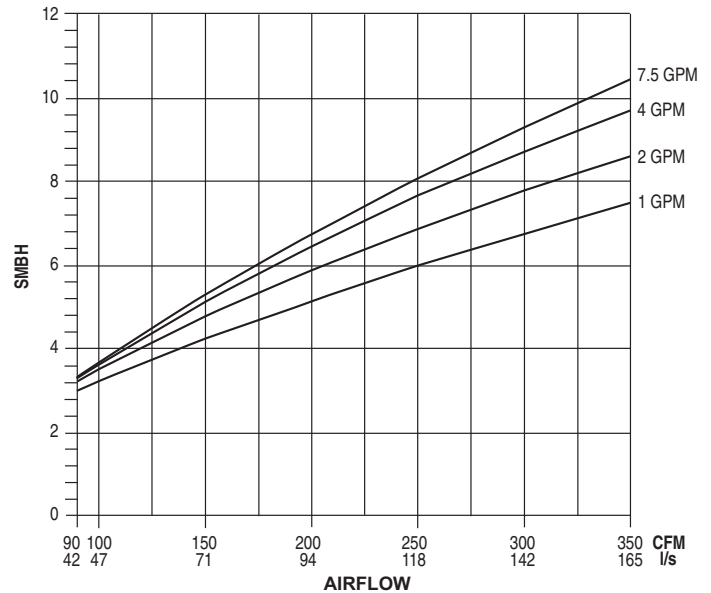

Altitude Correction Factors

Altitude (ft.)	0	1000	2000	3000	4000	5000	6000	7000
Air Density (lb./ft.3)	0.075	0.072	0.070	0.067	0.065	0.063	0.060	0.058
Total Capacity	1.000	0.988	0.986	0.983	0.981	0.979	0.977	0.975
Sensible Capacity	1.000	0.960	0.930	0.900	0.860	0.830	0.800	0.770
Static Pressure	1.000	0.960	0.930	0.900	0.860	0.830	0.800	0.770

Notes:

Capacity and static pressure will be affected for applications above sea level. To apply

correction factors, multiply factor by desired coil capacity or fan curve data.

Example: 38F Size XX with 3 row coil, high speed fan operation at 3000 ft. above sea level and with 0.1 inch. W.C. ESP.

Solution: Using correction factors from Altitude Correction chart for 3000 ft. above sea level, data from ARI Standard Ratings table and fan curves.

Total capacity = 12,500 BTUH (0.983) = 12,288 BTUH

Sensible Capacity = 8,000 BTUH (0.90) = 7,200 BTUH

SP = 0.1 (0.90) = 0.09 Inch W.C.

Model Series 38F • Underfloor Fan Coil Units

Performance Data • Chilled Water Coils • Unit Size 1

Data Based on 80°F DB 67°F WB Entering Air & 45°F Entering Water

5 Row (Total MBH)

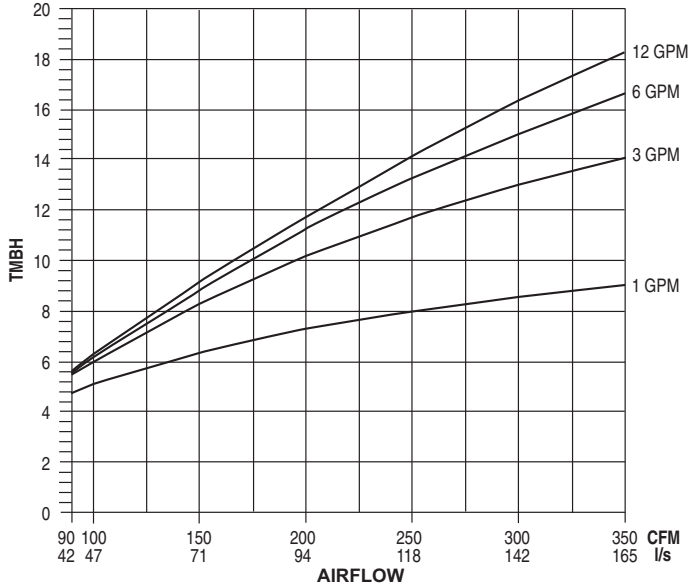

6 Row (Total MBH)

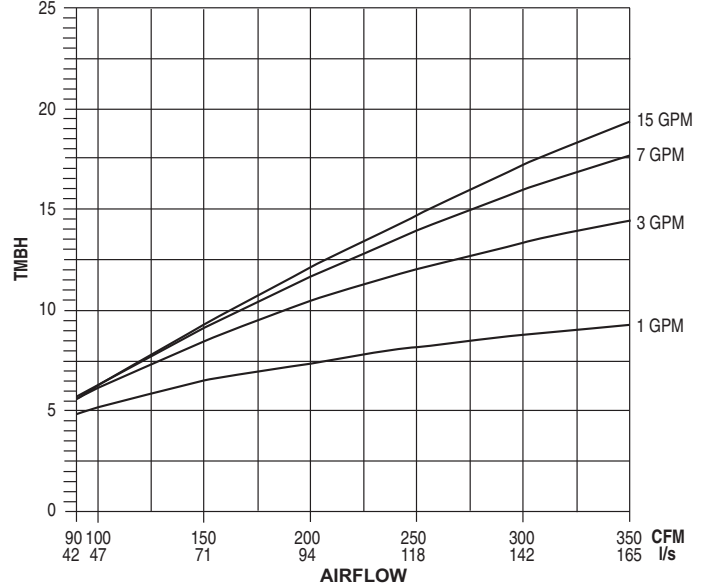

5 Row (Sensible MBH)

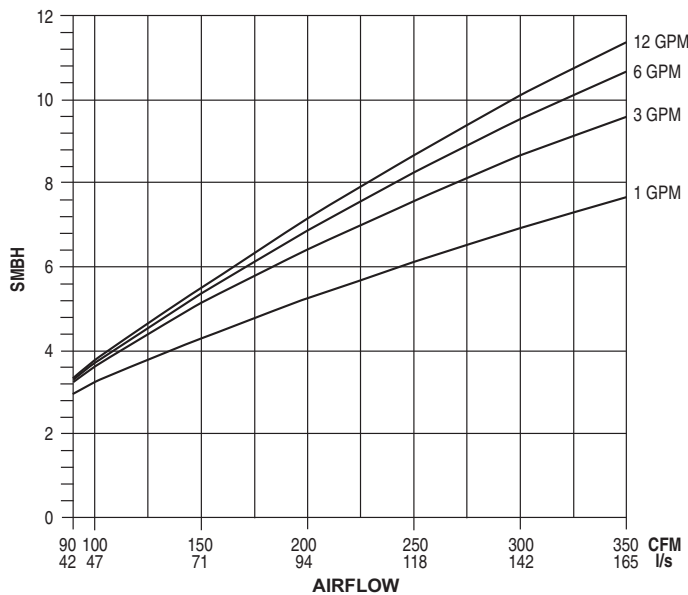

6 Row (Sensible MBH)

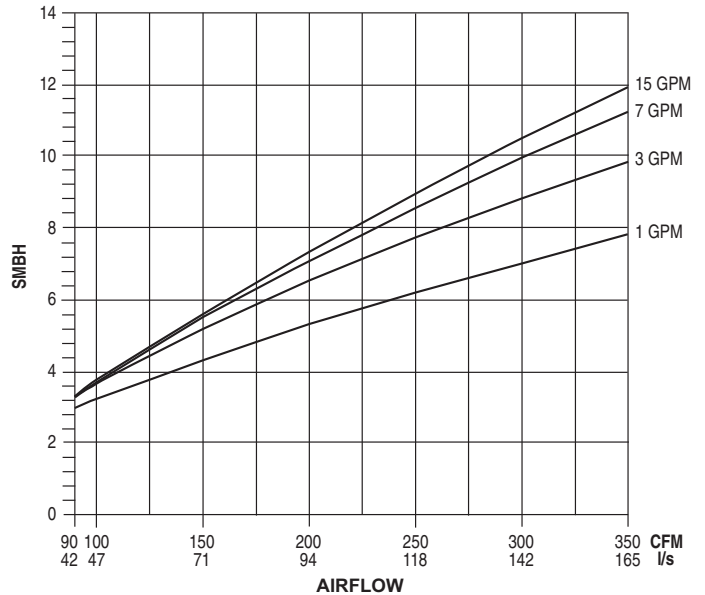

Altitude Correction Factors

Altitude (ft.)	0	1000	2000	3000	4000	5000	6000	7000
Air Density (lb./ft.3)	0.075	0.072	0.070	0.067	0.065	0.063	0.060	0.058
Total Capacity	1.000	0.988	0.986	0.983	0.981	0.979	0.977	0.975
Sensible Capacity	1.000	0.960	0.930	0.900	0.860	0.830	0.800	0.770
Static Pressure	1.000	0.960	0.930	0.900	0.860	0.830	0.800	0.770

Notes:

Capacity and static pressure will be affected for applications above sea level. To apply

correction factors, multiply factor by desired coil capacity or fan curve data.

Example: 38F Size XX with 3 row coil, high speed fan operation at 3000 ft. above sea level and with 0.1 inch. W.C. ESP.

Solution: Using correction factors from Altitude Correction chart for 3000 ft. above sea level, data from ARI Standard Ratings table and fan curves.

Total capacity = 12,500 BTUH (0.983) = 12,288 BTUH

Sensible Capacity = 8,000 BTUH (0.90) = 7,200 BTUH

SP = 0.1 (0.90) = 0.09 Inch W.C.



Model Series 38F • Underfloor Fan Coil Units Performance Data • Pressure Drop - Unit Size 1

Chilled Water Pressure Drop

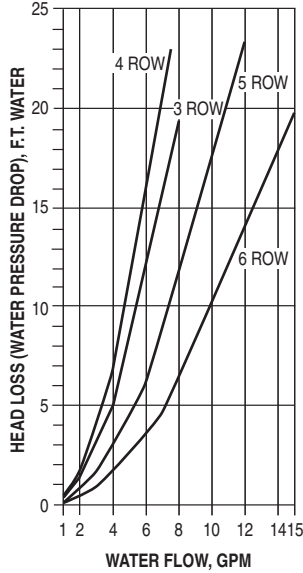

Hot Water Pressure Drop

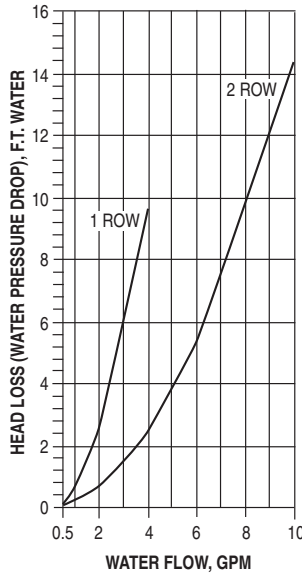

Chilled and Hot Water Air Pressure Drop

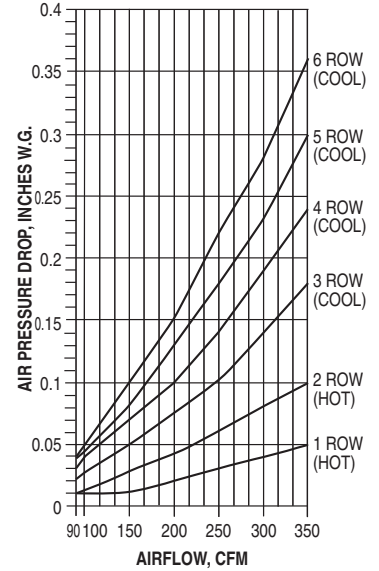

Metric Conversion Factors:

1. Water Flow (liters per second)
 $l/s = gpm \times 0.6309$
2. Water Head Loss (kilopascals):
 $kPa = ft. w.g. \times 2.9837$
3. Airflow Volume (liters per second)
 $l/s = CFM \times 0.472$

4. Air Pressure Drop (Pascals):
 $Pa = in. w.g. \times 248.6$
5. Heat (kilowatts):
 $kW = Mbh \times 0.293$
6. Air Temperature Rise.
 $ATR = 927 \times \frac{Mbh}{CFM}$

7. Water Temp. Drop.
 $WTD = 2.04 \times \frac{Mbh}{GPM}$
8. Connections:
1 Row 1/2" (13) O.D. male solder.

Model Series 38F • Underfloor Fan Coil Units

Performance Data • Hot Water Coils • Unit Size 3

Data Based on 70°F DB Entering Air & 180°F Entering Water

1 Row (Total MBH)

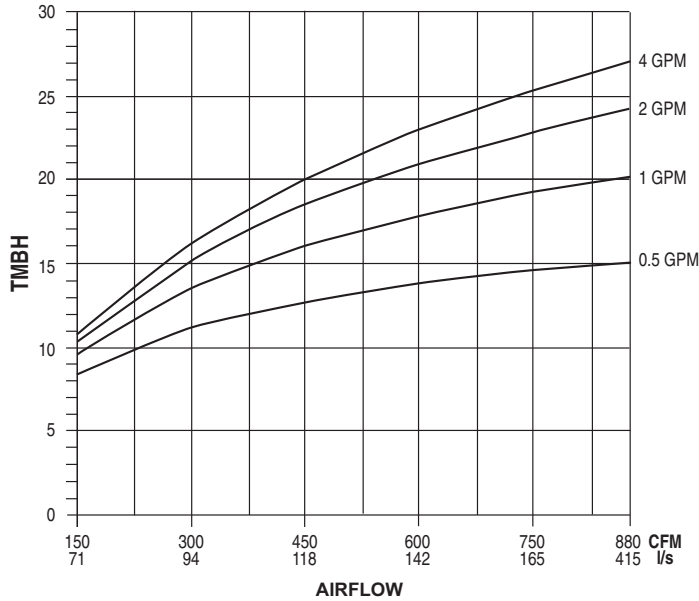

2 Row (Total MBH)

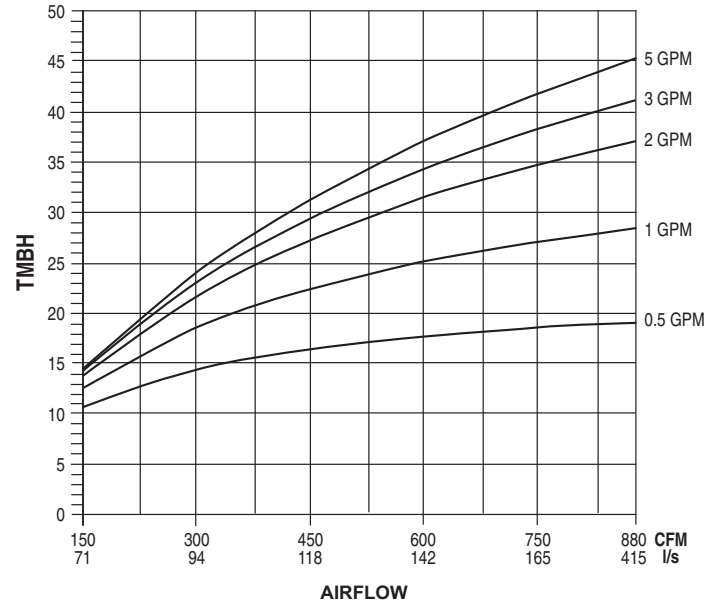

Notes:

- Capacities are in Mbh (thousands of Btu per hour).
- Mbh values are based on a ΔT (temperature difference) of 110°F between entering air and entering water. For other ΔT 's; multiply the Mbh values by the factors below.
- Air Temperature Rise. $ATR = \frac{927 \times \text{Mbh}}{\text{CFM}}$
- Water Temp. Drop. $WTD = \frac{2.04 \times \text{Mbh}}{\text{GPM}}$
- Connections: 1, 2 and 3 Row 7/8" (22); O.D. male solder.

Correction factors at other entering conditions:

ΔT °F	50	60	70	80	90	100	110	120	130	140	150
Factor	.455	.545	.636	.727	.818	.909	1.00	1.09	1.18	1.27	1.36

Altitude Correction Factors:

Altitude (ft.)	Sensible Heat Factor
0	1.00
2000	0.94
3000	0.90
4000	0.87
5000	0.84
6000	0.81
7000	0.78



Model Series 38F • Underfloor Fan Coil Units

Performance Data • Chilled Water Coils • Unit Size 3

Data Based on 65°F DB 59°F WB Entering Air & 45°F Entering Water

3 Row (Total MBH)

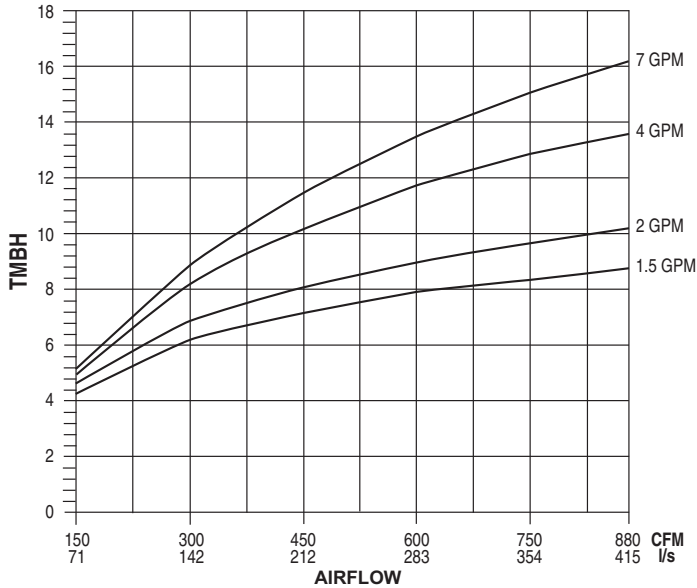

4 Row (Total MBH)

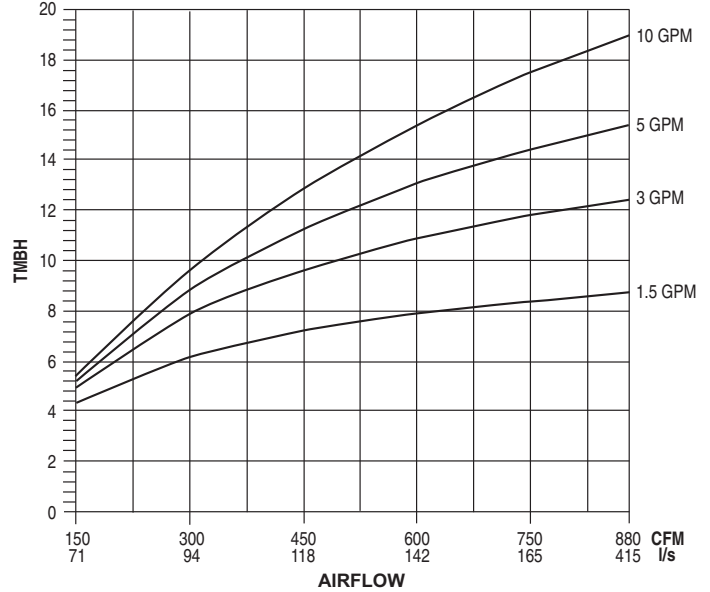

3 Row (Sensible MBH)

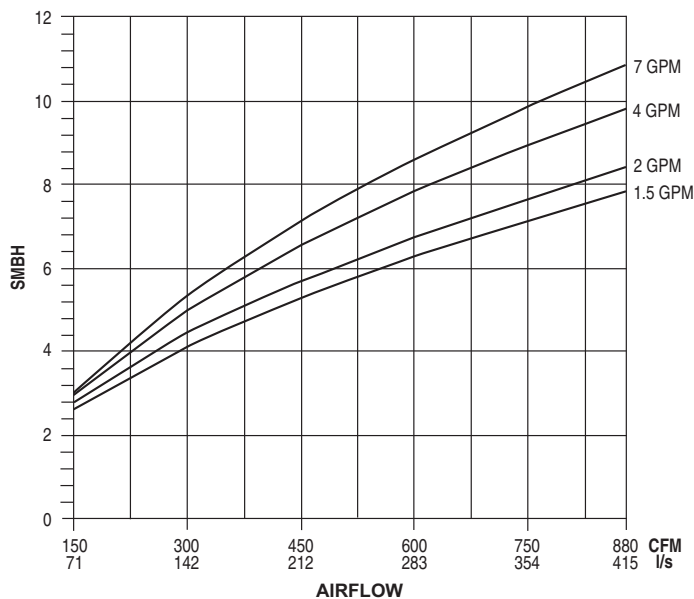

4 Row (Sensible MBH)

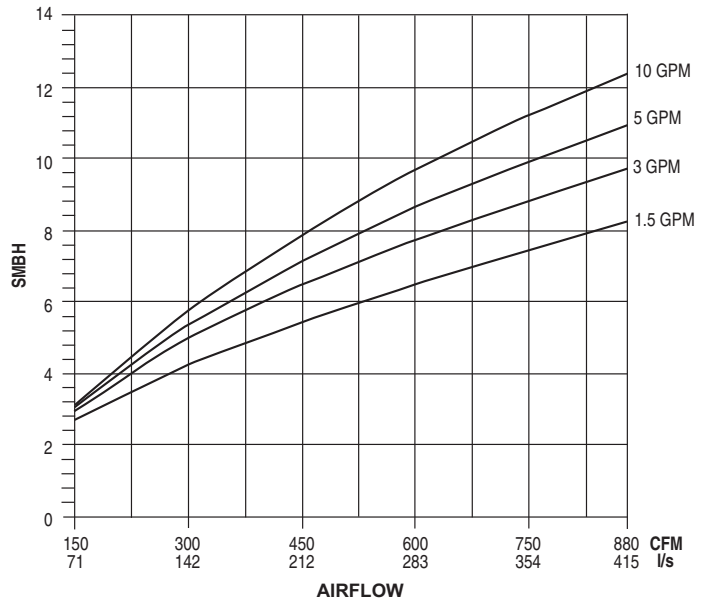

Altitude Correction Factors

Altitude (ft.)	0	1000	2000	3000	4000	5000	6000	7000
Air Density (lb./ft.3)	0.075	0.072	0.070	0.067	0.065	0.063	0.060	0.058
Total Capacity	1.000	0.988	0.986	0.983	0.981	0.979	0.977	0.975
Sensible Capacity	1.000	0.960	0.930	0.900	0.860	0.830	0.800	0.770
Static Pressure	1.000	0.960	0.930	0.900	0.860	0.830	0.800	0.770

Notes:

Capacity and static pressure will be affected for applications above sea level. To apply

correction factors, multiply factor by desired coil capacity or fan curve data.

Example: 38F Size XX with 3 row coil, high speed fan operation at 3000 ft. above sea level and with 0.1 inch. W.C. ESP.

Solution: Using correction factors from Altitude Correction chart for 3000 ft. above sea level, data from ARI Standard Ratings table and fan curves.

Total capacity = 12,500 BTUH (0.983) = 12,288 BTUH

Sensible Capacity = 8,000 BTUH (0.90) = 7,200 BTUH

SP = 0.1 (0.90) = 0.09 Inch W.C.

E UNDERFLOOR FAN COIL UNITS

Model Series 38F • Underfloor Fan Coil Units

Performance Data • Chilled Water Coils • Unit Size 3

Data Based on 65°F DB 59°F WB Entering Air & 45°F Entering Water

5 Row (Total MBH)

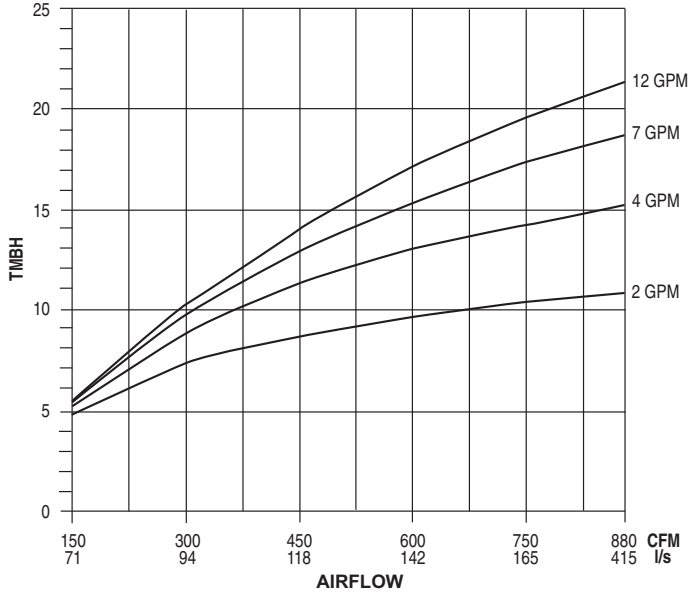

6 Row (Total MBH)

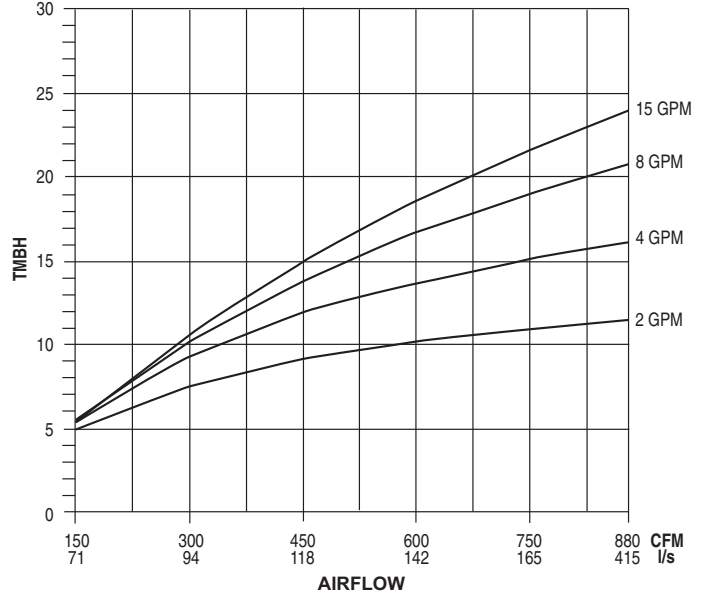

5 Row (Sensible MBH)

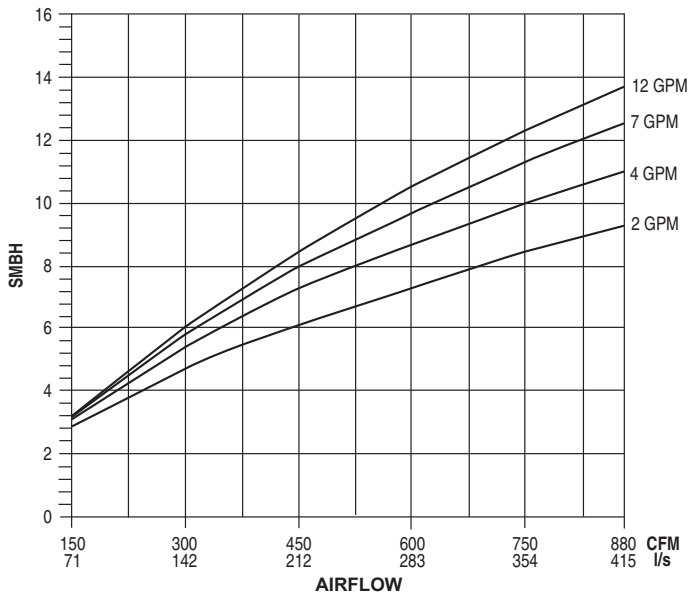

6 Row (Sensible MBH)

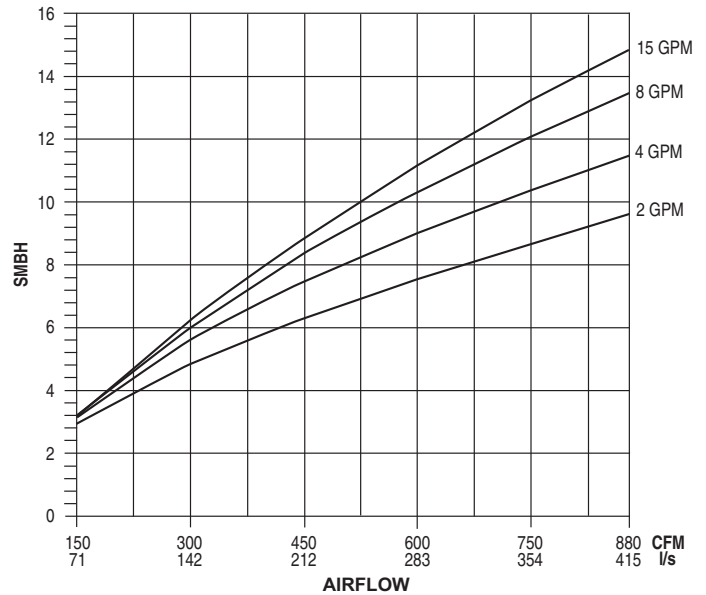

Altitude Correction Factors

Altitude (ft.)	0	1000	2000	3000	4000	5000	6000	7000
Air Density (lb./ft.3)	0.075	0.072	0.070	0.067	0.065	0.063	0.060	0.058
Total Capacity	1.000	0.988	0.986	0.983	0.981	0.979	0.977	0.975
Sensible Capacity	1.000	0.960	0.930	0.900	0.860	0.830	0.800	0.770
Static Pressure	1.000	0.960	0.930	0.900	0.860	0.830	0.800	0.770

Notes:

Capacity and static pressure will be affected for applications above sea level. To apply

correction factors, multiply factor by desired coil capacity or fan curve data.

Example: 38F Size XX with 3 row coil, high speed fan operation at 3000 ft. above sea level and with 0.1 inch. W.C. ESP.

Solution: Using correction factors from Altitude Correction chart for 3000 ft. above sea level, data from ARI Standard Ratings table and fan curves.

Total capacity = 12,500 BTUH (0.983) = 12,288 BTUH

Sensible Capacity = 8,000 BTUH (0.90) = 7,200 BTUH

SP = 0.1 (0.90) = 0.09 Inch W.C.



UNDERFLOOR FAN COIL UNITS

Model Series 38F • Underfloor Fan Coil Units

Performance Data • Chilled Water Coils • Unit Size 3

Data Based on 80°F DB 67°F WB Entering Air & 45°F Entering Water

3 Row (Total MBH)

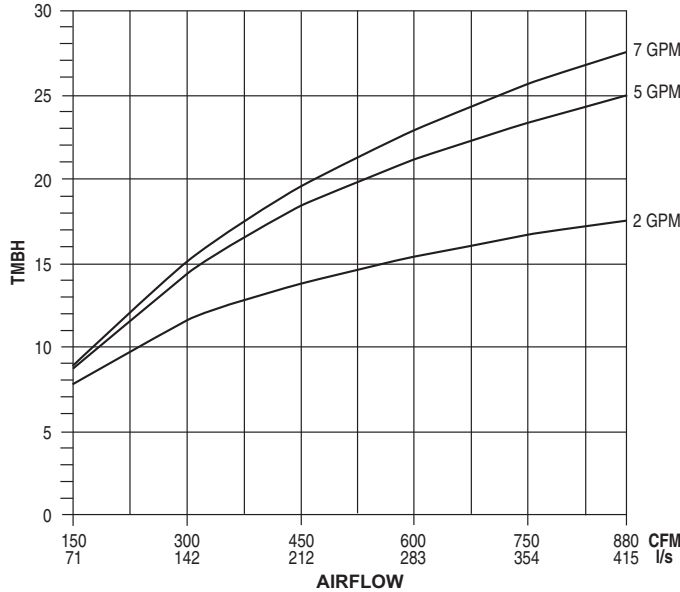

4 Row (Total MBH)

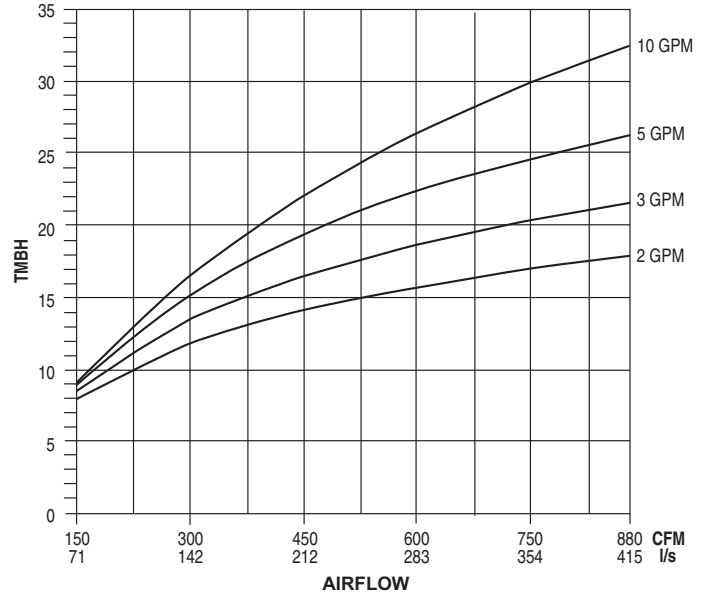

3 Row (Sensible MBH)

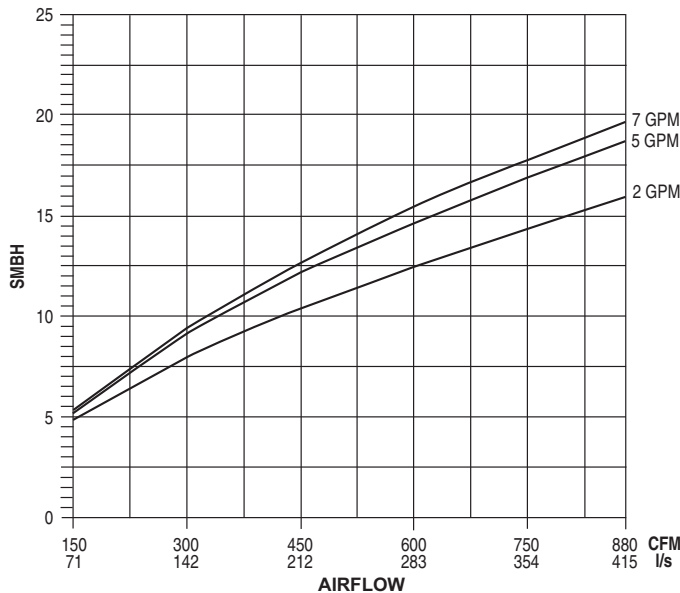

4 Row (Sensible MBH)

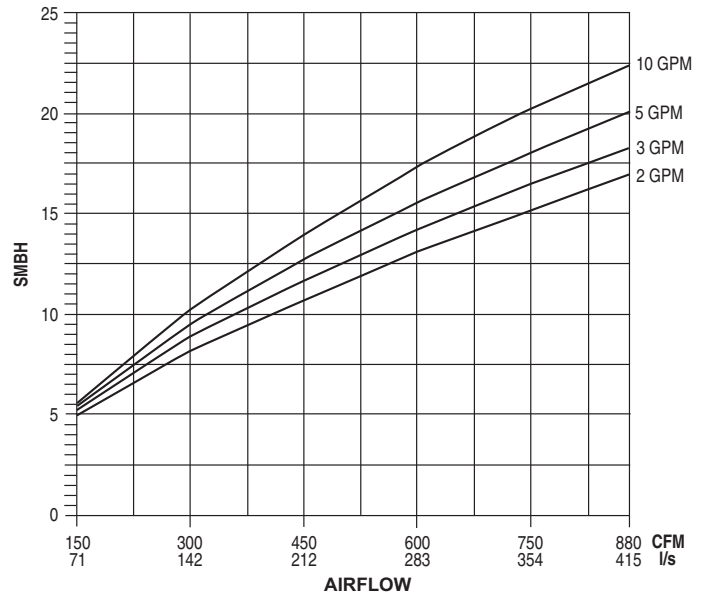

Altitude Correction Factors

Altitude (ft.)	0	1000	2000	3000	4000	5000	6000	7000
Air Density (lb./ft.3)	0.075	0.072	0.070	0.067	0.065	0.063	0.060	0.058
Total Capacity	1.000	0.988	0.986	0.983	0.981	0.979	0.977	0.975
Sensible Capacity	1.000	0.960	0.930	0.900	0.860	0.830	0.800	0.770
Static Pressure	1.000	0.960	0.930	0.900	0.860	0.830	0.800	0.770

Notes:

Capacity and static pressure will be affected for applications above sea level. To apply

correction factors, multiply factor by desired coil capacity or fan curve data.

Example: 38F Size XX with 3 row coil, high speed fan operation at 3000 ft. above sea level and with 0.1 inch. W.C. ESP.

Solution: Using correction factors from Altitude Correction chart for 3000 ft. above sea level, data from ARI Standard Ratings table and fan curves.

Total capacity = 12,500 BTUH (0.983) = 12,288 BTUH

Sensible Capacity = 8,000 BTUH (0.90) = 7,200 BTUH

SP = 0.1 (0.90) = 0.09 Inch W.C.

Model Series 38F • Underfloor Fan Coil Units

Performance Data • Chilled Water Coils • Unit Size 3

Data Based on 80°F DB 67°F WB Entering Air & 45°F Entering Water

5 Row (Total MBH)

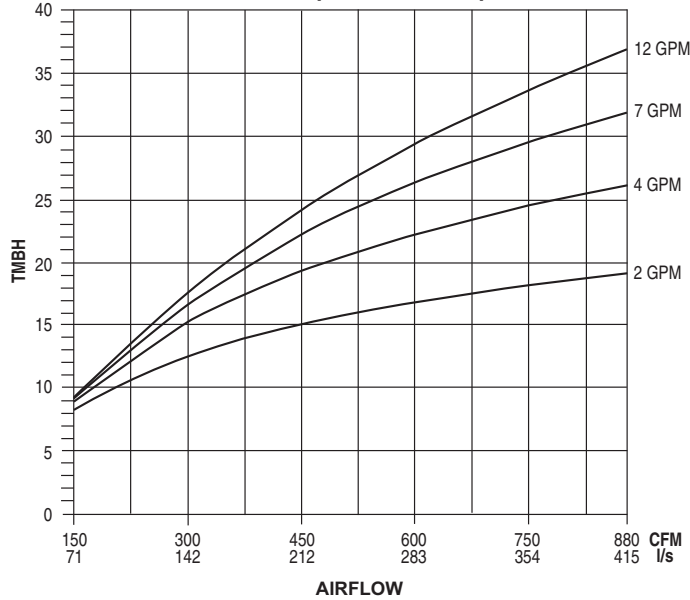

6 Row (Total MBH)

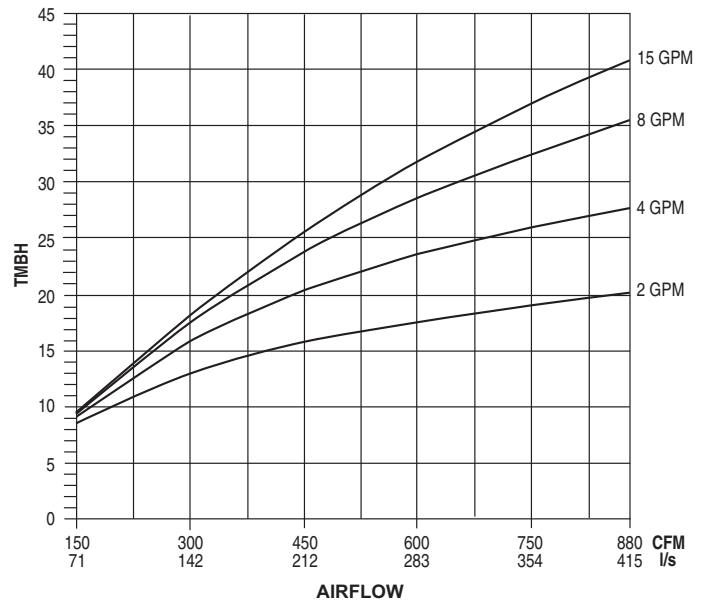

5 Row (Sensible MBH)

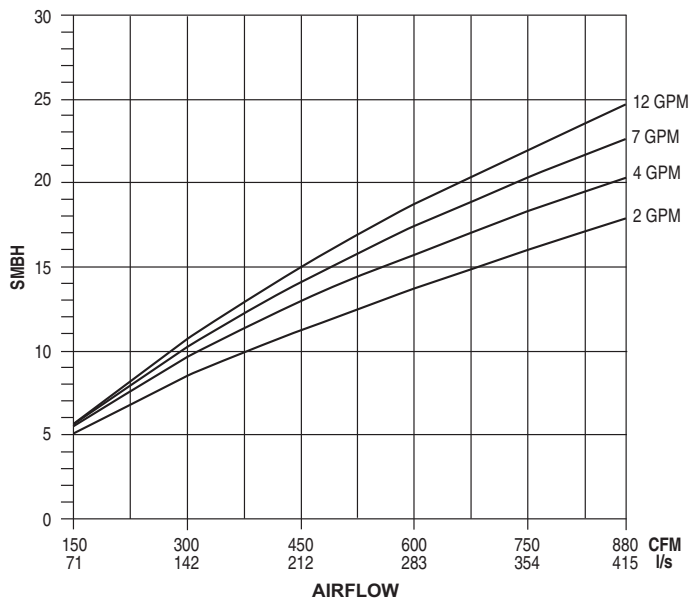

6 Row (Sensible MBH)

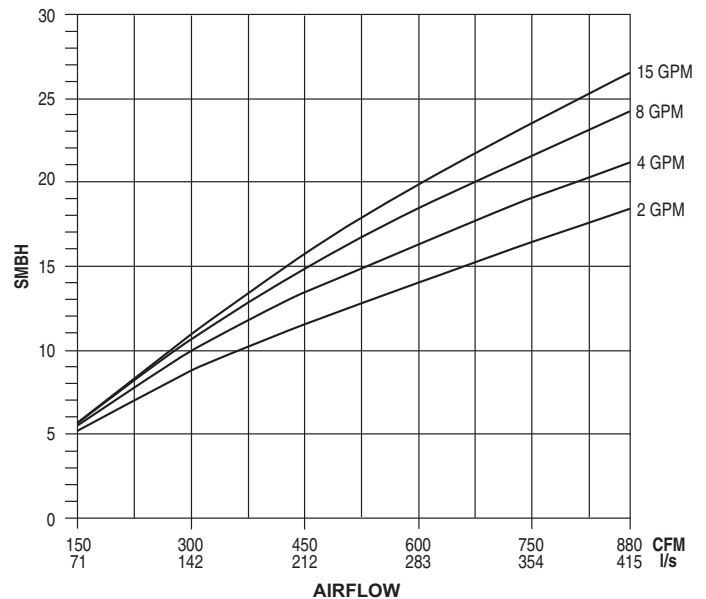

Altitude Correction Factors

Altitude (ft.)	0	1000	2000	3000	4000	5000	6000	7000
Air Density (lb./ft.3)	0.075	0.072	0.070	0.067	0.065	0.063	0.060	0.058
Total Capacity	1.000	0.988	0.986	0.983	0.981	0.979	0.977	0.975
Sensible Capacity	1.000	0.960	0.930	0.900	0.860	0.830	0.800	0.770
Static Pressure	1.000	0.960	0.930	0.900	0.860	0.830	0.800	0.770

Notes:

Capacity and static pressure will be affected for applications above sea level. To apply

correction factors, multiply factor by desired coil capacity or fan curve data.

Example: 38F Size XX with 3 row coil, high speed fan operation at 3000 ft. above sea level and with 0.1 inch. W.C. ESP.

Solution: Using correction factors from Altitude Correction chart for 3000 ft. above sea level, data from ARI Standard Ratings table and fan curves.

Total capacity = 12,500 BTUH (0.983) = 12,288 BTUH

Sensible Capacity = 8,000 BTUH (0.90) = 7,200 BTUH

SP = 0.1 (0.90) = 0.09 Inch W.C.



Model Series 38F • Underfloor Fan Coil Units Performance Data • Pressure Drop - Unit Size 3

Chilled Water Pressure Drop

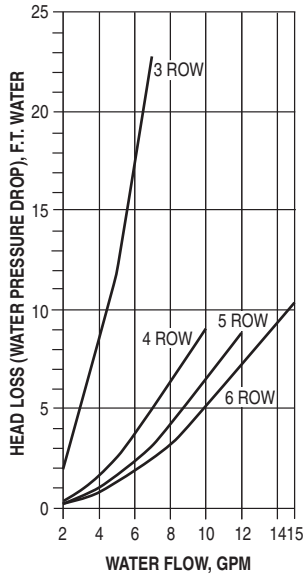

Hot Water Pressure Drop

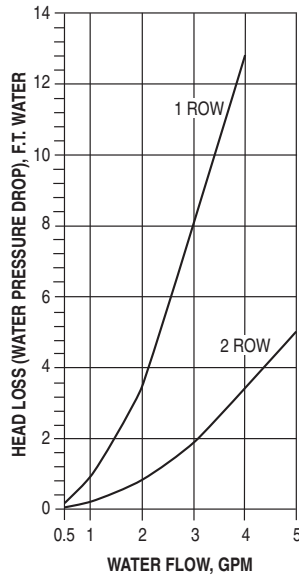

Chilled and Hot Water Air Pressure Drop

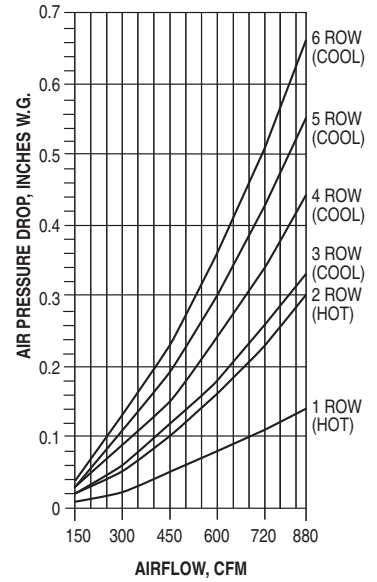

Metric Conversion Factors:

1. Water Flow (liters per second)
 $l/s = gpm \times 0.6309$
2. Water Head Loss (kilopascals):
 $kPa = ft. w.g. \times 2.9837$
3. Airflow Volume (liters per second)
 $l/s = CFM \times 0.472$

4. Air Pressure Drop (Pascals):
 $Pa = in. w.g. \times 248.6$
5. Heat (kilowatts):
 $kW = Mbh \times 0.293$
6. Air Temperature Rise:
 $ATR = 927 \times \frac{Mbh}{CFM}$

7. Water Temp. Drop.
 $WTD = 2.04 \times \frac{Mbh}{GPM}$
8. Connections:
1 Row 1/2" (13) O.D. male solder.

Model Series 38F • Underfloor Fan Coil Units
Performance Data • Hot Water Coils • Unit Size 5
Data Based on 70°F DB Entering Air & 180°F Entering Water
1 Row (Total MBH)

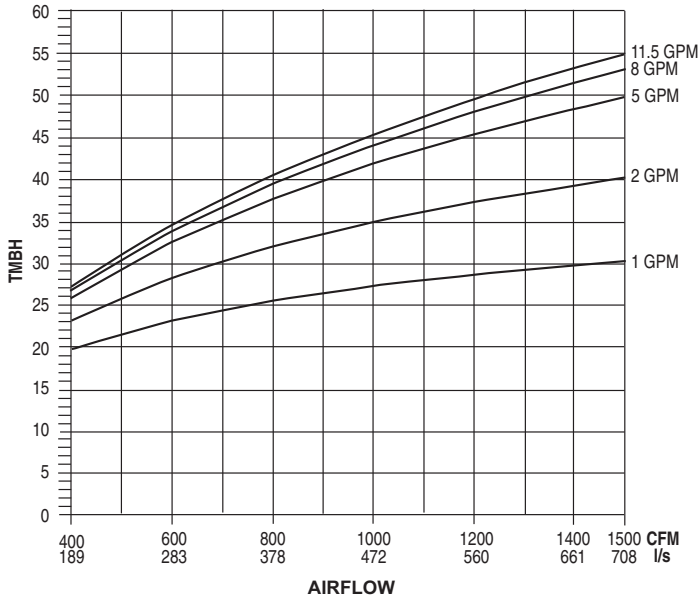

Notes:

- Capacities are in Mbh (thousands of Btu per hour).
- Mbh values are based on a ΔT (temperature difference) of 110°F between entering air and entering water. For other ΔT 's; multiply the Mbh values by the factors below.
- Air Temperature Rise. $ATR = \frac{927 \times Mbh}{CFM}$
- Water Temp. Drop. $WTD = \frac{2.04 \times Mbh}{GPM}$
- Connections: 1, 2 and 3 Row 7/8" (22); O.D. male solder.

Correction factors at other entering conditions:

ΔT °F	50	60	70	80	90	100	110	120	130	140	150
Factor	.455	.545	.636	.727	.818	.909	1.00	1.09	1.18	1.27	1.36

Altitude Correction Factors:

Altitude (ft.)	Sensible Heat Factor
0	1.00
2000	0.94
3000	0.90
4000	0.87
5000	0.84
6000	0.81
7000	0.78



Model Series 38F • Underfloor Fan Coil Units

Performance Data • Chilled Water Coils • Unit Size 5

Data Based on 80°F DB 67°F WB Entering Air & 45°F Entering Water

3 Row (Total MBH)

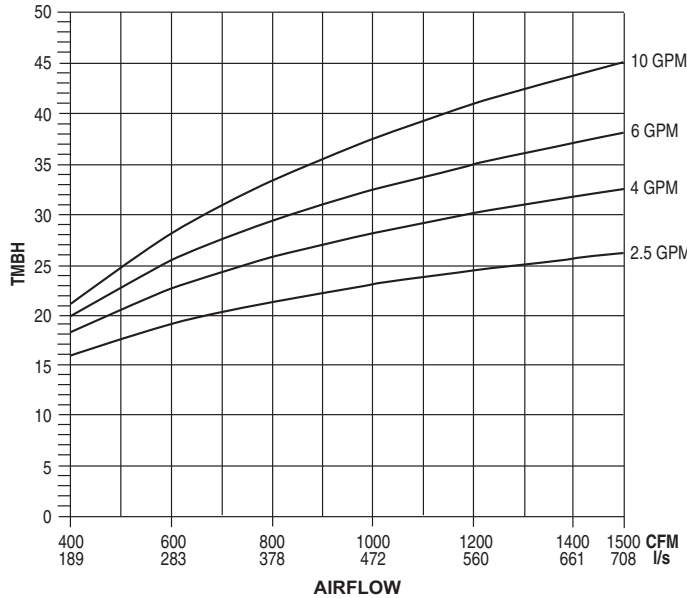

4 Row (Total MBH)

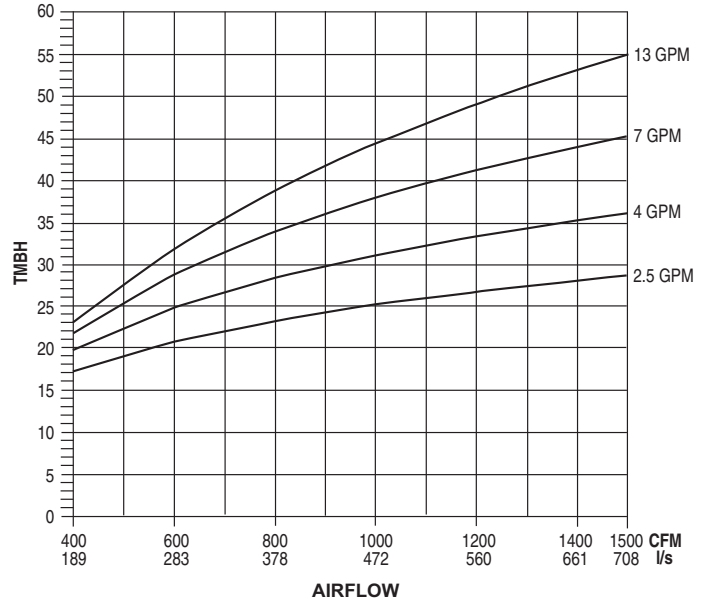

3 Row (Sensible MBH)

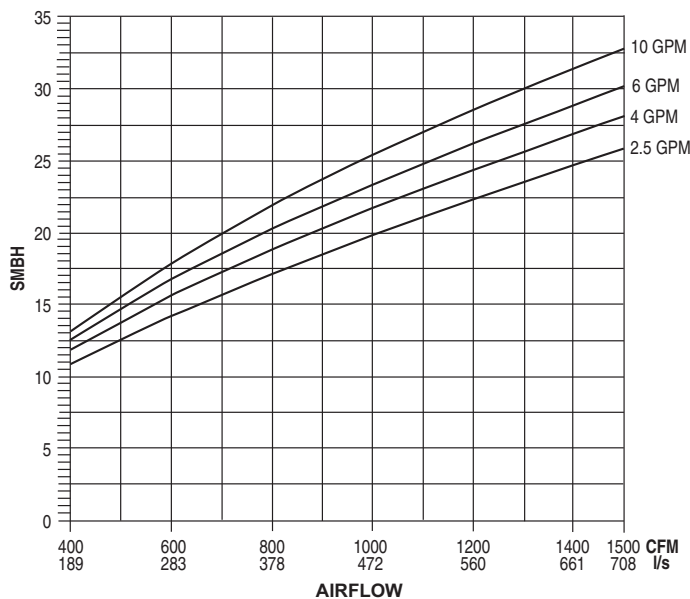

4 Row (Sensible MBH)

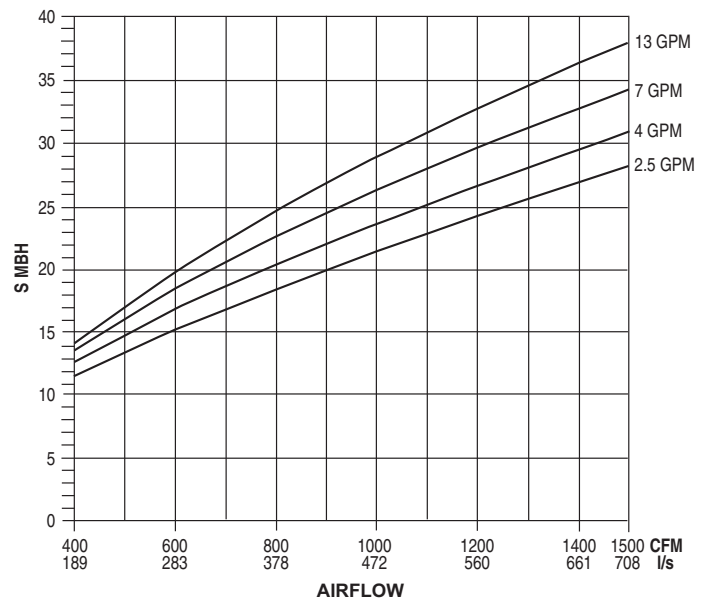

Altitude Correction Factors

Altitude (ft.)	0	1000	2000	3000	4000	5000	6000	7000
Air Density (lb./ft.3)	0.075	0.072	0.070	0.067	0.065	0.063	0.060	0.058
Total Capacity	1.000	0.988	0.986	0.983	0.981	0.979	0.977	0.975
Sensible Capacity	1.000	0.960	0.930	0.900	0.860	0.830	0.800	0.770
Static Pressure	1.000	0.960	0.930	0.900	0.860	0.830	0.800	0.770

Notes:

Capacity and static pressure will be affected for applications above sea level. To apply

correction factors, multiply factor by desired coil capacity or fan curve data.

Example: 38F Size XX with 3 row coil, high speed fan operation at 3000 ft. above sea level and with 0.1 inch. W.C. ESP.

Solution: Using correction factors from Altitude Correction chart for 3000 ft. above sea level, data from ARI Standard Ratings table and fan curves.

Total capacity = 12,500 BTUH (0.983) = 12,288 BTUH

Sensible Capacity = 8,000 BTUH (0.90) = 7,200 BTUH

SP = 0.1 (0.90) = 0.09 Inch W.C.

Model Series 38F • Underfloor Fan Coil Units Performance Data • Pressure Drop - Unit Size 5

Chilled Water Pressure Drop

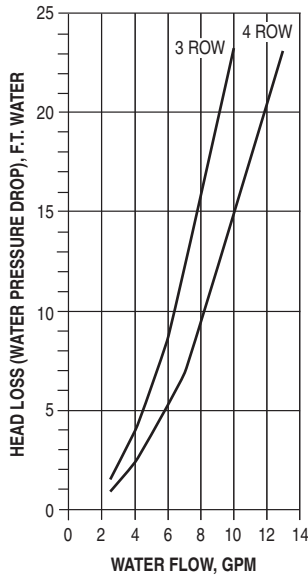

Hot Water Pressure Drop

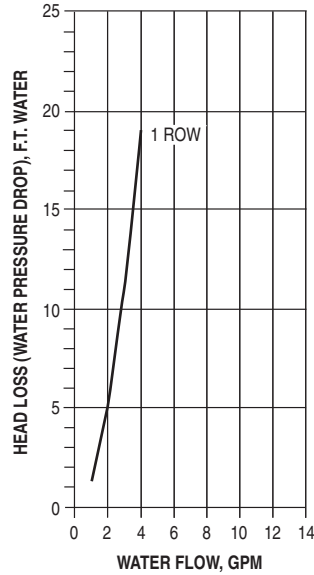

Chilled and Hot Water Air Pressure Drop

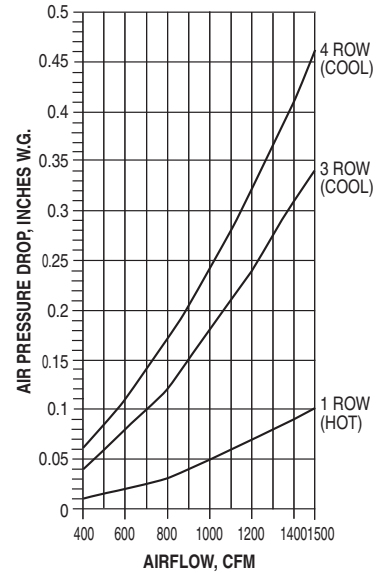

Metric Conversion Factors:

- Water Flow (liters per second)
 $l/s = \text{gpm} \times 0.6309$
- Water Head Loss (kilopascals):
 $kPa = \text{ft. w.g.} \times 2.9837$
- Airflow Volume (liters per second)
 $l/s = \text{CFM} \times 0.472$
- Air Pressure Drop (Pascals):
 $Pa = \text{in. w.g.} \times 248.6$
- Heat (kilowatts):
 $kW = \text{Mbh} \times 0.293$
- Air Temperature Rise.
 $ATR = 927 \times \frac{\text{Mbh}}{\text{CFM}}$
- Water Temp. Drop.
 $\text{WTD} = 2.04 \times \frac{\text{Mbh}}{\text{GPM}}$
- Connections:
1 Row 1/2" (13) O.D. male solder.

Electric Heating Coils • Construction Features, Selection and Capacities

Nailor Electric Coils are tested with the fan terminal in accordance with UL Standard 1995 and meet all requirements of the National Electric Code and CSA. Units are listed and labeled by the ETL Testing Laboratory as a total package. All controls are enclosed in a NEMA 1 electrical enclosure on the side of the fan package for easy access.

All wiring for the motor and heater terminates in the enclosure for single point electrical connection in the field. Each unit is supplied with a wiring diagram. Note: NEC requires a means to disconnect the heater power supply within sight or on the terminal.

Standard Features Include:

- Automatic reset high limit thermal cut-outs.
- Nickel-chrome heating elements.
- Magnetic contactors per stage on terminals with DDC or analog electronic controls.
- P.E. switch per stage to carry load or pilot duty with magnetic contactors as required with pneumatic control.
- Positive pressure airflow safety switch or CT relay.
- Fan relay for DDC fan coils.
- Control voltage transformer (Class 2) for DDC or analog electronic fan coils.

Optional Accessories:

- Toggle disconnect switch.
- Door interlocking disconnect switch.
- Mercury contactors.
- Power circuit fusing.
- Dust tight control enclosure.
- Class 'A' 80/20 nickel/chrome element wire.
- Manual reset high limits.
- SCR Control.



Tested and approved to the following standards:

ANSI/UL 1996, 1st. ed.
CSA C22.2 No. 155-M1986.
UL 1995

SCR Control Option:

The SCR (Thyristor) option provides infinite solid state heater control using a proportional signal (0 – 10 Vdc or 4 – 20 mA). This option may be specified compatible with analog electronic or digital (DDC) controls.

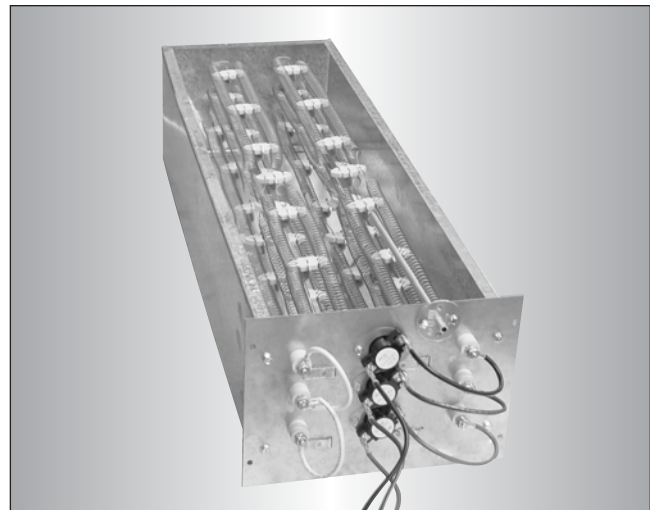

Time proportional control of the electric heater provides superior comfort and energy savings. The SCR controller modulates the heater to supply the exact amount of heat based upon the zone requirement. Room set points are maintained more accurately, undershoot and overshoot as associated with staged heat are eliminated, reducing operation costs.

SCR controllers provide silent operation, as mechanical staged contactors are eliminated. Zero cross switching of the thyristor prevents electrical noise.

Recommended Selection:

The table below is a quick reference guide, to illustrate the relationship between electrical power supply, heater capacity in kilowatts and fan coil unit sizes that are available.

- Pneumatic and digital control terminals are available with up to 3 stages of heat. Analog electronic control terminals are available with 1 or 2 stages of heat only. A minimum of 0.5 kW per stage is required.
- Voltage and kilowatt ratings are sized so as not to exceed 48 amps, in order to avoid the NEC code requirement for circuit fusing.
- A minimum airflow of 70 cfm (33 l/s) per kW is required for any given fan coils in order to avoid possible nuisance tripping of the thermal cut-outs.
- Discharge air temperature should not exceed 120°F (49°C).

Model Series	Unit Size	Electric Heat Maximum Kilowatts												
		120V 1 Ph	208/220/240V 1 Ph	277V 1 Ph	347V 1Ph	480V 1 Ph	600V 1Ph (120V Fan)	600V 1Ph (240/277V Fan)	208V 3Ph	220/240V 3Ph	380V 3Ph	480V 3Ph	600V (120V Fan)	600V (240/277V Fan)
38F	1	4.8	5	5	5	5	5	5	—	—	—	—	—	—
	2	4.8	8	9	9	9	9	9	9.5	8	9	9	9	
	3	4.8	8	11.5	13	14	14	14	9	9.5	8	10	12	12
	5	5.4	9.3	12.4	15.6	21.6	21.6	21.6	10.8	10.8	11.7	12.4	14.1	14.1
	6	5.4	9.3	12.4	15.6	23.2	23.2	23.2	12.6	13.3	14.5	16.6	19.3	19.3
	33	4.8	8	11.5	13	14	14	14	9	9.5	8	10	12	12

Electric Heating Coils • Application Guidelines

Discharge Air Temperature

When considering the capacity and airflow for the heater, discharge air temperature can be an important factor. Rooms use different types of diffusers, and they are intended to perform different functions. Slots that blend the air at the glass and set up air curtains within the room, must be able to blow the air very low in the room. Hot air will be too buoyant to be effective in this case. Discharge air temperatures for this application should be in the 85 – 90°F (29 – 32°C) maximum range.

Diffusers in the center of the room blend their discharge air as it crosses the ceiling. Discharge air temperatures in this application can be as high as 105°F (41°C) and still be effective. However, if the return air grilles are in the discharge air pattern, the warm air will be returned to the plenum before it heats the room. Again, the air temperature needs to be blended down to an acceptable temperature that can be forced down into the occupied space by the time the air gets to the walls. Discharging warm air into the room at temperatures above 105°F (41°C) usually will set up stratification layers and will not keep the occupants warm if there is a ceiling return because only the top 12" – 24" (300 – 600 mm) of the room will be heated.

The maximum approved discharge air temperature for any Nailor Fan Coil Units with supplemental heat is 120°F (49°C). No heater should be applied to exceed this temperature.

Electric Heater Selection

To properly select an electric heater, three things must be determined: the heat requirement for the room, the entering air temperature and the desired discharge air temperature. The heat requirement for the room is the sum of the heat loss calculation and the amount of heat required to raise the entering air temperature to the desired room temperature. Usually, the second item is small compared to the first for fan coil units in a return air plenum. MBH can be converted to kW by using the chart or by calculation. There are 3413 BTU's in 1 kW. If using the chart, find the MBH on the left scale, then move horizontally to the right and read kW.

Next, the desired discharge air temperature should be ascertained. This will depend on the type of diffusers that are in the room.

The desired heating airflow for the room can then be calculated using the following equation:

$$cfm = \frac{kW \times 3160}{\Delta T \text{ (discharge air temp - inlet air temp.) } ^\circ F}$$

Assuming 70°F (21°C) supply air temperature to the heater, the room airflow can be selected directly from the chart. Start at the left at the design kW. Move horizontally to the desired discharge air temperature. Then, move vertically down to the cfm at the bottom of the chart.

The kW can be selected directly from the chart. Start at the bottom with the design cfm into the room. Move vertically up to the line that represents the desired discharge air temperature. Then, move left to the kW.

The discharge air temperature can also be selected directly from the chart. Start at the bottom with the design cfm into the room. Move to the left side of the chart and find the design kW. Move horizontally and vertically into the chart until the lines intersect. The intersection will be the desired discharge air temperature. Interpolation between the curves is linear.

Heater Selection Chart

Assuming 70°F inlet air temperature at heater.

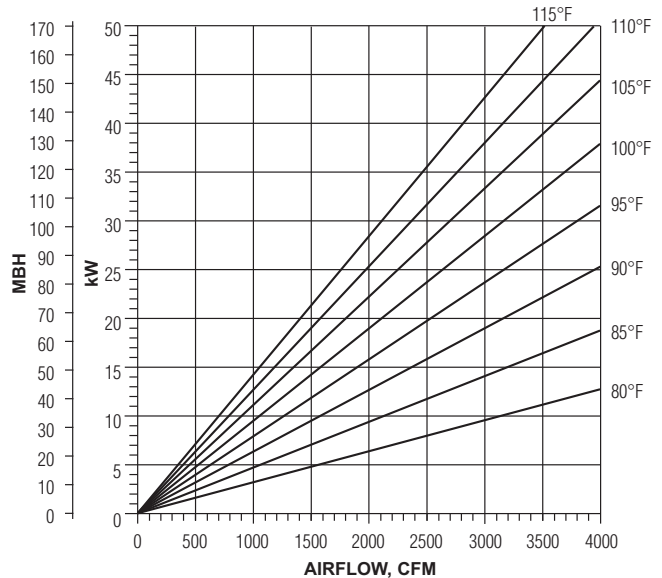

Diagonal lines are constant output temperature.

Optional Fan Coil Unit Liners For 'IAQ' Sensitive Applications

Nailor offers several options for fan coil unit applications where the maintenance of a high Indoor Air Quality is a primary concern. Specific 'IAQ' liners are designed to address applications where the issue of fiberglass insulation eroding and entering the airstream is a concern and/or to reduce the risk of microbial growth.

The sound power levels published in this catalog for fan coil units are based upon testing with standard dual density fiberglass insulation. Dual density insulation is surface treated to prevent erosion and was developed to optimize attenuation for unit applications. Cataloged discharge sound power levels for fan coil units are not significantly affected by the different liner options, however radiated sound levels may escalate depending on the unit model and liner selection. Contact your Nailor representative for further information.

Fiber-Free Liner

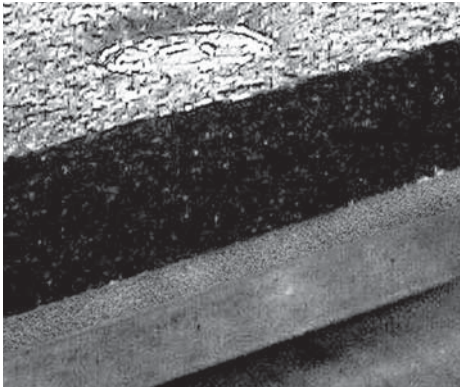

Fiber-Free liner.

A new offering that totally eliminates fiberglass; Nailor's Fiber-Free liner is 3/4" (19) thick, closed cell elastomeric foam. The liner has excellent thermal insulating characteristics. The foam does not absorb water, reducing the likelihood of mold or bacterial growth.

The Fiber-Free liner surface is smooth, so that dirt and debris won't accumulate, durable, erosion resistant and washable.

Complies with the following standards and tests:

- NFPA 90A Supplementary materials for air distribution systems.
- ASTM E84 and UL 181 (25/50) Smoke and Flame spread.
- ASTM C1071, G21, G22. No bacterial or fungal growth.
- Acoustical attenuation of radiated sound is reduced compared with standard dual density fiberglass insulation.

Steri-Liner

Steri-Liner is an internal insulation designed to reduce the risk of microbial growth within the unit. A smooth non-porous facing provides a vapor barrier to moisture and reduces the risk of micro-organisms becoming trapped. It also facilitates cleaning and prevents insulating material erosion. Damage to the liner though, will expose fiberglass particles to the airstream.

- 13/16" (21) thick, 4 lb./sq. ft. (64 kg/m³) density rigid fiberglass with a fire resistant reinforced aluminum foil-scrim-kraft (FSK) facing on all panels in the mixing chamber.
- Meets the requirements of NFPA 90A and UL 181 for smoke and flame spread and the bacteriological requirements of ASTM C665. Will not support the growth of fungi or bacteria.
- No exposed edges. Steri-Liner features 'notch and tuck' fabrication and full seam length steel Z-strip construction providing both superior edge protection and an extremely rigid unit.

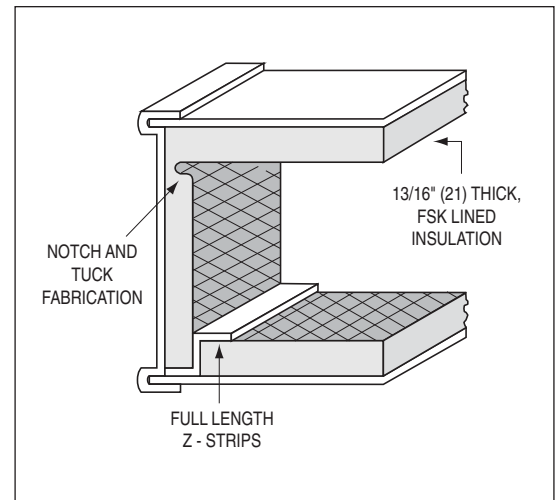

Steri-Liner detail on 38F Series fan coil unit.

Solid Metal Liner

Nailor also offers a solid inner metal liner that completely isolates the standard insulation from the airstream within the unit mixing chamber. Solid metal liners offer the ultimate protection against exposure of fiberglass particles to the airstream, all but eliminating the possibility of punctures exposing fiberglass. This option is also resistant to moisture. The encased insulation still provides thermal resistance and radiated sound attenuation, but acoustic absorption of discharge sound is eliminated.

Fabricated as a box within a box to separate all surfaces and exposed edges of the insulation.

Perforated Metal Liner

Provides additional security and retains standard dual density fiberglass insulation or optional Steri-Liner insulation reducing possibility of long term erosion or breakdown.

Model Series 38F • Underfloor Fan Coil Units Valve Packages • Chilled/Hot Water

Single Component for Chilled/Hot Water

CODE C/H001:
2-WAY 2 POSITION VALVE

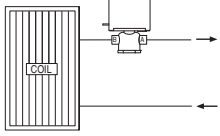

CODE C/H002:
2-WAY VALVE W/MODULATION

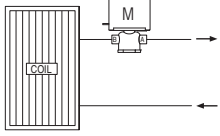

CODE C/H003:
3-WAY 2 POSITION VALVE

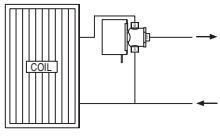

CODE C/H004:
3-WAY VALVE WITH MODULATION

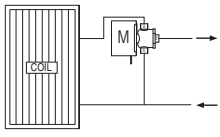

CODE C/H005:
FIXED FLOW CONTROL

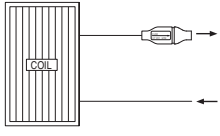

CODE C/H006:
ADJUSTABLE FLOW CONTROL

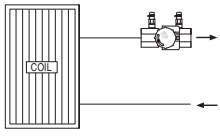

CODE C/H007:
BALL VALVES

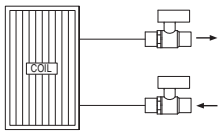

CODE C/H008: BALL VALVES
W/MEMORY STOP, PT PORTS

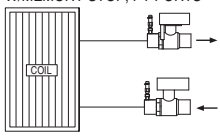

CODE C/H009:
BYPASS VALVE

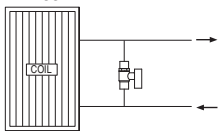

2-Way 2-Position Chilled/Hot Water Valve Packages

CODE C/H010:
BALL VALVES

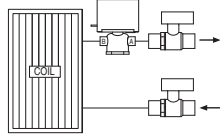

CODE C/H011:
FLOW CONTROL

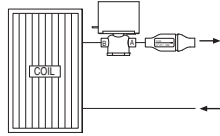

CODE C/H012:
ADJUST. FLOW CONTROL

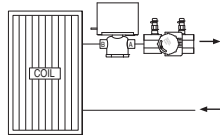

CODE C/H013:
Y-STRAINER

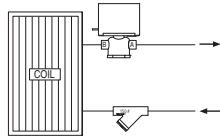

CODE C/H014:
Y-STRAINER W/HOSE BIB

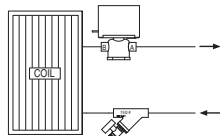

CODE C/H015: UNIONS
(AVAILABLE ON ALL VALVE PACKAGES)

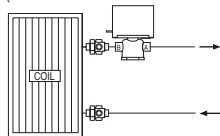

CODE C/H016: BALL VALVES
W/MEMORY STOP, PT PORTS

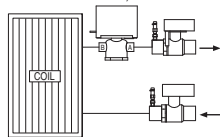

CODE C/H017: BALL VALVES,
FIXED FLOW CONTROL

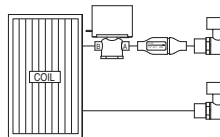

CODE C/H018: FIXED FLOW CONTROL,
Y-STRAINER

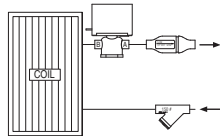

CODE C/H019: FIXED FLOW CONTROL,
Y-STRAINER W/HOSE BIB

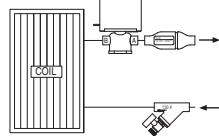

CODE C/H020: BALL VALVES,
FIXED FLOW CONTROL, Y-STRAINER

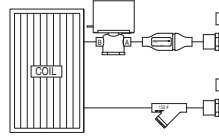

CODE C/H021: BALL VALVES, FIXED FLOW
CONTROL, Y-STRAINER W/HOSE BIB

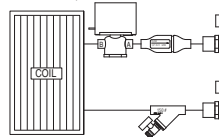

CODE C/H022: BALL VALVES
ADJUST. FLOW CONTROL

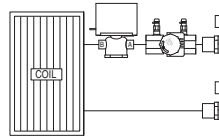

CODE C/H023: ADJUST. FLOW CONTROL,
Y-STRAINER

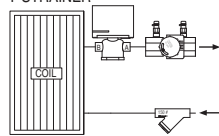

CODE C/H024: ADJUST. FLOW CONTROL
Y-STRAINER W/HOSE BIB

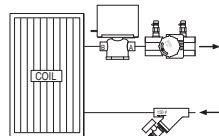

CODE C/H025: BALL VALVES, ADJUST.
FLOW CONTROL, Y-STRAINER

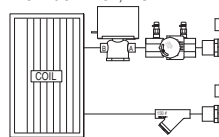

CODE C/H026: BALL VALVES, ADJUST.
FLOW CONTROL, Y-STRAINER W/HOSE BIB

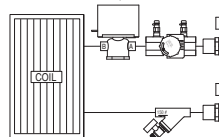

2-Way Modulating Valve, Chilled/Hot Water Valve Packages

CODE C/H027:
BALL VALVES

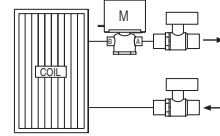

CODE C/H028:
FIXED FLOW CONTROL

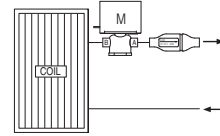

CODE C/H029:
ADJUST. FLOW CONTROL

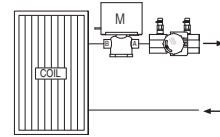

CODE C/H030:
Y-STRAINER

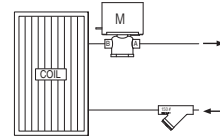

CODE C/H031:
Y-STRAINER W/HOSE BIB

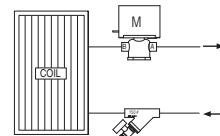

CODE C/H032: UNIONS
(AVAILABLE ON ALL VALVE PACKAGES)

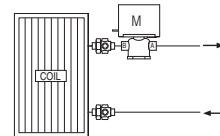

CODE C/H033: BALL VALVES
W/MEMORY STOP, PT PORTS

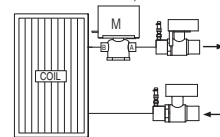

CODE C/H034: BALL VALVES,
FIXED FLOW CONTROL

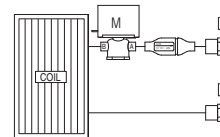

CODE C/H035: FIXED FLOW CONTROL,
Y-STRAINER

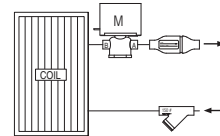

CODE C/H036: FIXED FLOW CONTROL,
Y-STRAINER W/HOSE BIB

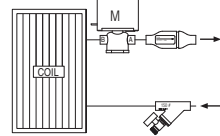

CODE C/H037: BALL VALVES,
FIXED FLOW CONTROL, Y-STRAINER

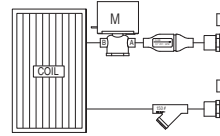

CODE C/H038: BALL VALVES, FIXED
FLOW CONTROL, Y-STRAINER W/HOSE BIB

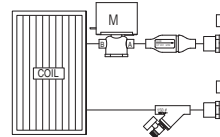

CODE C/H039: BALL VALVES,
ADJUST. FLOW CONTROL

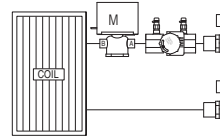

CODE C/H040: ADJUST. FLOW
CONTROL, Y-STRAINER

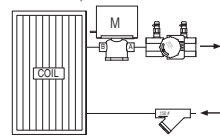

CODE C/H041: ADJUST. FLOW
CONTROL, Y-STRAINER W/HOSE BIB

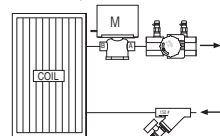

CODE C/H042: BALL VALVES, ADJUST.
FLOW CONTROL, Y-STRAINER

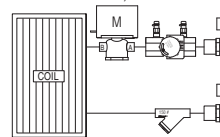

CODE C/H043: BALL VALVES, ADJUST.
FLOW CONTROL, Y-STRAINER W/HOSE BIB

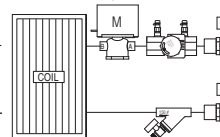

Model Series 38F • Underfloor Fan Coil Units Valve Packages • Chilled/Hot Water • 3-Way, 2-Position Valve

CODE C/H044:
BALL VALVES

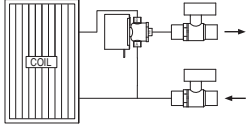

CODE C/H045:
FIXED FLOW CONTROL

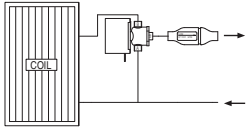

CODE C/H046:
ADJUST. FLOW CONTROL

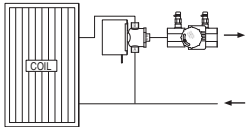

CODE C/H047:
Y-STRAINER

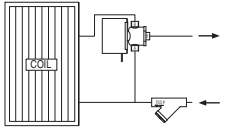

CODE C/H048:
Y-STRAINER W/HOSE BIB

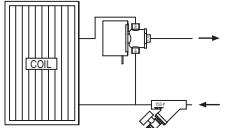

CODE C/H049: UNIONS
(AVAILABLE ON ALL VALVE PACKAGES)

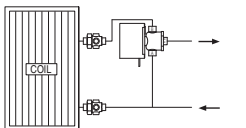

CODE C/H050: BALL VALVES
W/MEMORY STOP, PT PORTS

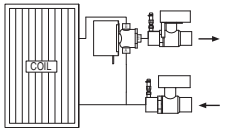

CODE C/H051: BALL VALVES
FIXED FLOW CONTROL

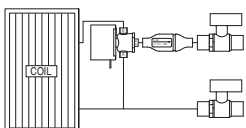

CODE C/H052: FIXED FLOW CONTROL,
Y-STRAINER

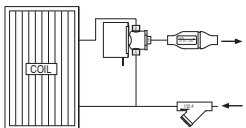

CODE C/H053: FIXED FLOW CONTROL
Y-STRAINER W/HOSE BIB

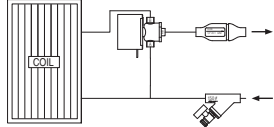

CODE C/H054: BALL VALVES, FIXED
FLOW CONTROL, Y-STRAINER

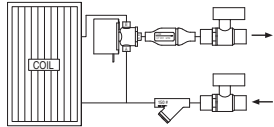

CODE C/H055: BALL VALVES, FIXED FLOW
CONTROL, Y-STRAINER W/ HOSE BIB

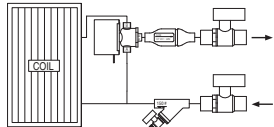

CODE C/H056: BALL VALVES,
ADJUST. FLOW CONTROL

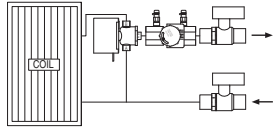

CODE C/H057: ADJUST. FLOW
CONTROL,

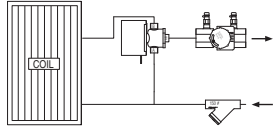

CODE C/H058: ADJUST. FLOW CONTROL,
Y-STRAINER W/HOSE BIB

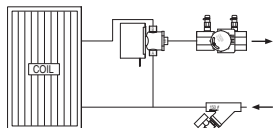

CODE C/H059: BALL VALVES, ADJUST.
FLOW CONTROL, Y-STRAINER

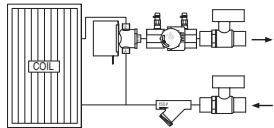

CODE C/H060: BALL VALVES, ADJUST.
FLOW CONTROL, Y-STRAINER W/HOSE BIB

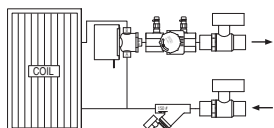

CODE C/H061: BALL VALVES,
BYPASS VALVE

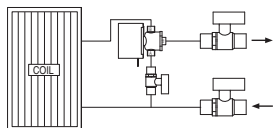

CODE C/H062: BYPASS VALVE,
FIXED FLOW CONTROL

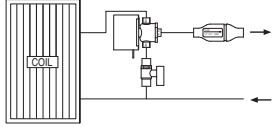

CODE C/H063: BYPASS VALVE
ADJUST. FLOW CONTROL

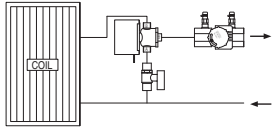

CODE C/H064: BYPASS VALVE
Y-STRAINER

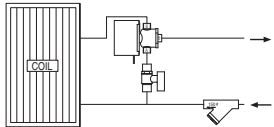

CODE C/H065: BYPASS VALVE
Y-STRAINER W/HOSE BIB

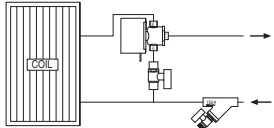

CODE C/H066: UNIONS,
BYPASS VALVE

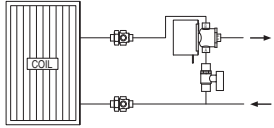

CODE C/H067: BALL VALVES W/ MEMORY
STOP, PT PORTS

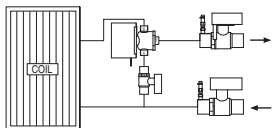

CODE C/H068: BYPASS VALVE,
BALL VALVES, FIXED FLOW CONTROL

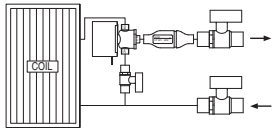

CODE C/H069: BYPASS VALVE,
FIXED FLOW CONTROL, Y-STRAINER

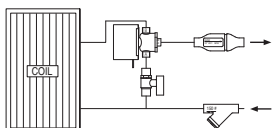

CODE C/H070: BYPASS VALVE, FIXED FLOW
CONTROL, Y-STRAINER W/HOSE BIB

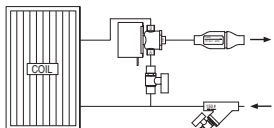

CODE C/H071: BYPASS VALVE, BALL
VALVES

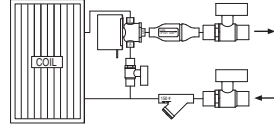

CODE C/H072: BALL VALVES, FIXED FLOW
CONTROL, BYPASS VALVE, Y-STRAINER W/HOSE

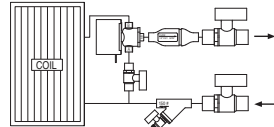

CODE C/H073: BYPASS VALVE, BALL
VALVES, ADJUST. FLOW CONTROL

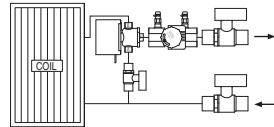

CODE C/H074: BYPASS VALVE,
ADJUST. FLOW CONTROL, Y-STRAINER

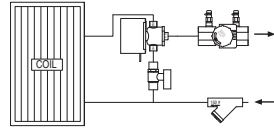

CODE C/H075: BYPASS VALVE, ADJUST.
FLOW CONTROL, Y-STRAINER W/HOSE BIB

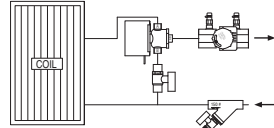

CODE C/H076: BYPASS VALVE, BALL VALVES,
ADJUST. FLOW CONTROL, Y-STRAINER

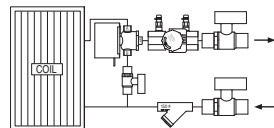

CODE C/H077: BALL VALVES, ADJUST. FLOW
CONTROL, BYPASS VALVE, Y-STRAINER W/HOSE BIB

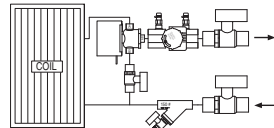

Model Series 38F • Underfloor Fan Coil Units Valve Packages • Chilled/Hot Water • 3-Way Modulating Valve

E

UNDERFLOOR FAN COIL UNITS

CODE C/H078:
BALL VALVES

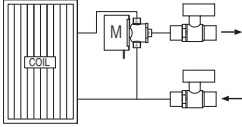

CODE C/H087: FIXED FLOW CONTROL
Y-STRAINER W/HOSE BIB

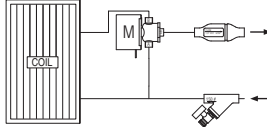

CODE C/H096: BYPASS VALVE,
FIXED FLOW CONTROL

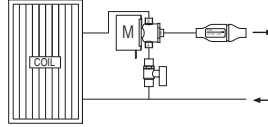

CODE C/H105: BYPASS VALVE, BALL VALVES,
FIXED FLOW CONTROL, Y-STRAINER

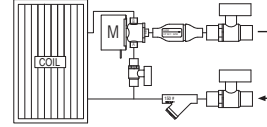

CODE C/H079:
FIXED FLOW CONTROL

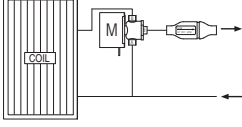

CODE C/H088: BALL VALVES, FIXED
FLOW CONTROL, Y-STRAINER

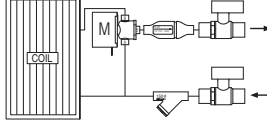

CODE C/H097: BYPASS VALVE
ADJUST. FLOW CONTROL

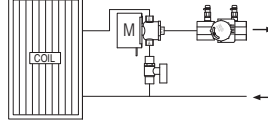

CODE C/H106: BALL VALVES, FIXED FLOW CONTROL,
BYPASS VALVE, Y-STRAINER W/HOSE BIB

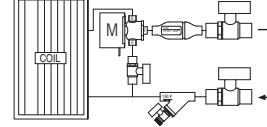

CODE C/H080:
ADJUST. FLOW CONTROL

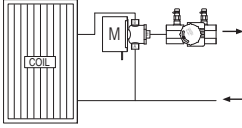

CODE C/H089: BALL VALVES, FIXED FLOW
CONTROL, Y-STRAINER W/HOSE BIB

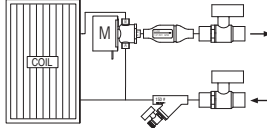

CODE C/H098:
BYPASS VALVE, Y-STRAINER

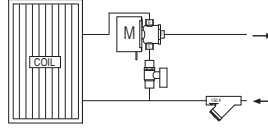

CODE C/H107: BYPASS VALVE, BALL VALVES
ADJUST. FLOW CONTROL

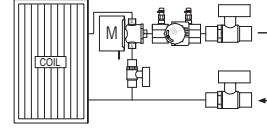

CODE C/H081:
Y-STRAINER

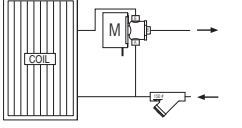

CODE C/H090: BALL VALVES
ADJUST. FLOW CONTROL

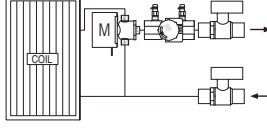

CODE C/H099: BYPASS VALVE,
Y-STRAINER W/HOSE BIB

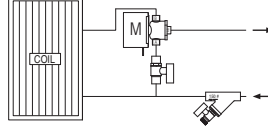

CODE C/H108: BYPASS VALVE,
ADJUST. FLOW CONTROL, Y-STRAINER

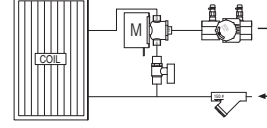

CODE C/H082:
Y-STRAINER W/HOSE BIB

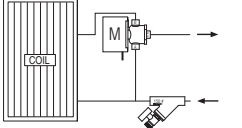

CODE C/H091: ADJUST. FLOW CONTROL,
Y-STRAINER

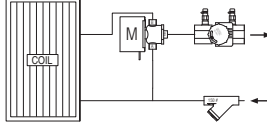

CODE C/H100: UNIONS,
BYPASS VALVE

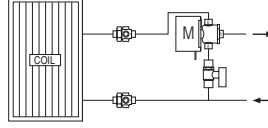

CODE C/H109: BYPASS VALVE, ADJUST.
FLOW CONTROL, Y-STRAINER W/HOSE BIB

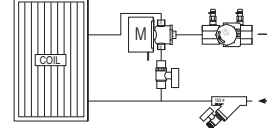

CODE C/H083: UNIONS
(AVAILABLE ON ALL VALVE PACKAGE)

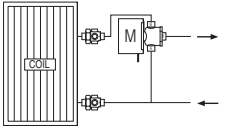

CODE C/H092: ADJUST. FLOW CONTROL
Y-STRAINER W/HOSE BIB

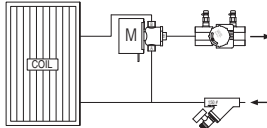

CODE C/H101: BALL VALVES W/MEMORY
STOP, PT PORTS

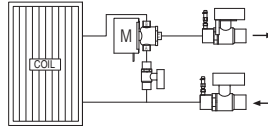

CODE C/H110: BYPASS VALVE, BALL VALVES,
ADJUST. FLOW CONTROL, Y-STRAINER

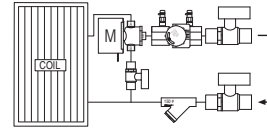

CODE C/H084: BALL VALVES
W/MEMORY STOP, PT PORTS

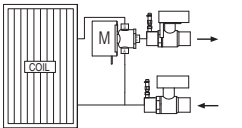

CODE 93: BALL VALVES,
ADJUST. FLOW CONTROL, Y-STRAINER

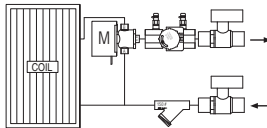

CODE C/H102: BYPASS VALVE, BALL
VALVES, FIXED FLOW CONTROL

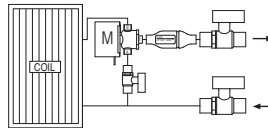

CODE C/H111: BALL VALVES, ADJUST. FLOW CONTROL,
BYPASS VALVE, Y-STRAINER W/HOSE BIB

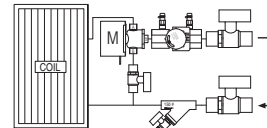

CODE C/H085: BALL VALVES
FIXED FLOW CONTROL

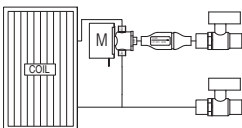

CODE C/H094: BALL VALVES, ADJUST.
FLOW CONTROL, Y-STRAINER W/ HOSE BIB

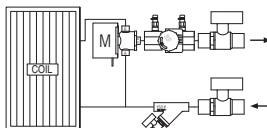

CODE C/H103: BYPASS VALVE,
FIXED FLOW CONTROL, Y-STRAINER

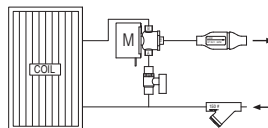

CODE C/H086: FIXED FLOW
CONTROL, Y-STRAINER

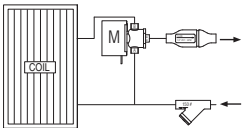

CODE C/H095: BALL VALVES,
BYPASS VALVE

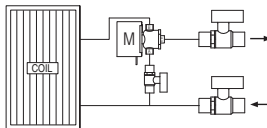

CODE C/H104: BYPASS VALVE, FIXED
FLOW CONTROL, Y-STRAINER W/HOSE BIB

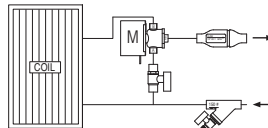

Suggested Specifications • Underfloor Fan Coil Units • Model Series 38F

PART 1 – GENERAL

1.01 RELATED DOCUMENTS

A. The requirements of the general conditions, supplementary conditions, and the following specification sections apply to all work herein:

1. Section 15??? -- General.
2. Section 15??? -- Scope of Work.
3. Section 15??? -- Design Conditions.
4. Section 15??? -- Electric Motors and Controllers.
5. Section 15??? -- Access Doors and Color Coded Identification in General Construction.
6. Section 15??? -- Ductwork and Sheet Metal.
7. Section 15??? -- Testing, Balancing, and Adjusting.

1.02 SUMMARY

A. Furnish and install all fan coil units herein specified and as indicated on the drawings.

1.03 REFERENCE STANDARDS

A. All fan coil units shall be designed, manufactured, and tested in accordance with the latest applicable industry standards including the following:

1. ANSI/ASHRAE Standard 130-96.
2. ARI Standard 440
3. ARI Standard 880-98.
4. Underwriters Laboratories UL Standard 1995.
5. Underwriters Laboratories UL Standard 1996.

1.04 QUALITY ASSURANCE

A. All equipment and material to be furnished and installed on this project shall be UL or ETL listed, in accordance with the requirements of the authority having jurisdiction, and suitable for its intended use on this project. Space limitations shall be reviewed to ensure that the equipment will fit into the space allowed.

B. All equipment and material to be furnished and installed on this project shall be run tested at the factory and results of that testing shall be tabulated and provided to the engineer when the equipment ships to the job site. See paragraph 2.03 J for specific requirements.

C. All equipment and material to be furnished and installed on this project shall have been pre-tested in a mock-up facility suitable to the engineer. The test shall be as described in 2.03 D. The test results shall be supplied with the equipment submittal.

1.05 SUBMITTALS

A. The following submittal data shall be furnished according to the conditions of the construction contract, Division 1 specifications, and Section 15010 and shall include but not be limited to:

1. **Underfloor Fan Coil Units**, complete with capacity data, test data, construction details, physical dimensions, electrical characteristics, etc.

1.06 ACOUSTICS

Section A of this acoustical specification describes sound power levels as tested to ARI 880 and ASHRAE 130. These are not the selection criteria for this specification. The selection criteria will be in section B where sound pressure readings are taken in an

actual mock-up that will exhibit worst case performance for the purpose of guaranteeing equipment performance when the building is commissioned and turned over to the occupant. Section A is important in that it provides a guideline for the minimum performance that the fan coil units will have to meet in order to anticipate performance that will be acceptable under section B.

A. Sound Power Acoustical Performance:

1. **Discharge Noise:** Maximum permissible sound-power levels in octave bands of discharge sound through discharge ducts from fan coil units operated at an inlet pressure of 0.1" w.g. and the maximum amount of air volume shown on the project mechanical drawings leaving the fan coil unit and entering the reverberant chamber shall be as follows:

DISCHARGE SOUND POWER (dB re 10 ⁻¹² Watt)		
Octave Band	NC-35	NC-40
2	64	67
3	65	67
4	66	68
5	64	66
6	61	63
7	59	62

2. **Radiated Noise:** Maximum permissible radiated sound-power levels in octave bands of radiated transmission from fan coil units operated at an inlet pressure of 0.1" w.g. and the maximum scheduled air quantity in an installed condition over occupied spaces shall be as follows:

RADIATED SOUND POWER (dB re 10 ⁻¹² Watt)		
Octave Band	NC-35	NC-40
2	64	68
3	56	61
4	49	54
5	48	53
6	47	52
7	51	56

B. Sound Pressure Acoustical Performance:

Each size of each fan coil unit to be used on this project shall be completely laboratory tested for air performance and acoustics. Performance to NC 30, 35, 40 and 45 shall be charted for each size unit showing its maximum and minimum range limits under each NC condition listed above. If heater options change the overall performance, then the equipment shall be shown with electric and hot water coils in addition to no heat configurations. This data shall be submitted with the equipment submittal. Units that comply with the sound power data listed above may comply with the sound pressure performance. Testing is required to determine compliance and the performance range. Units that do not comply with the sound power performance in paragraph 1.06 A. probably will not comply with the sound pressure requirements or will have restricted ranges of acceptance.

1.07 WARRANTY

Manufacturer shall warrant equipment for one year from start up or 18 months from shipment.

Suggested Specifications • Underfloor Fan Coil Units • Model Series 38F

PART 2 – PRODUCTS

2.01 UNAUTHORIZED MATERIALS

A. Materials and products required for the work of this section shall not contain asbestos, polychlorinated biphenyl's (PCB) or other hazardous materials identified by the engineer or owner.

2.02 ACCEPTABLE MANUFACTURERS

A. These specifications set forth the minimum requirements for fan coil units. If they comply with these specifications, fan coil units manufactured by one of the following manufacturers will be acceptable:

1. Nailor Industries.

2.03 VARIABLE PRIMARY AIR VOLUME FAN COIL UNITS

A. Furnish and install underfloor fan coil units as indicated on the drawings. The units shall be designed and built as a single unit and provided with or without a primary variable air volume damper that controls the primary air quantity in response to a temperature control signal. The damper construction shall be rectangular with multiple opposed blades designed to operate on a 45° arc. Blades shall be heavy gauge galvanized steel, single thickness construction with heavy-duty gasket glued to the blades. Units shall be suitable for pressure independent control with [pneumatic, analog electronic or electronic DDC] controls. The units shall contain a fan and motor assembly and [electric or hot water] heating coils where scheduled and/or chilled water cooling coils where scheduled or indicated on the drawings. The fan shall provide a constant volume of discharge air at all air blending ratios from minimum to maximum scheduled primary air quantities and zero to 100% return airflow rates and shall be controlled in sequence as outlined hereinafter. The space limitations shall be reviewed carefully to ensure all fan coil units will fit into the space provided including National Electric Code clearances required in front of all panels containing electrical devices. Units shall have removable access doors or panels of minimum 20 gauge galvanized steel on the top of the fan coil unit that shall provide access to service the fan, electric motor and all internal components. Panels shall be attached with [screws or quick connect latches or hinges]. Unit shall be fully lined with at least 1/2" thick, dual density fiberglass insulation complying with NFPA 90 for fire and smoke resistivity and UL 181 for erosion. Any cut edges of insulation shall be coated with NFPA 90 approved sealant. Drain pans shall be of stainless steel construction and internally pitched to provide positive drain free performance. Casing leakage shall not exceed 2% of terminal rated airflow at 0.1" wg. interior casing pressure. Provide a filter rack with a 1" thick throwaway filter to be used during construction.

When scheduled, the fan coil unit manufacturer shall provide flow curves for the primary air sensor clearly labeled and permanently attached on the bottom or side of each fan terminal.

The unit shall include all equipment and controls as required to provide a complete and operating system with at least the following equipment and controls:

1. Single point electrical connection for the voltage/phase as scheduled in the contract documents. See electrical drawings for power feeder arrangements. Motors shall be rated at [277 single phase or 120 single phase] as scheduled in the contract documents.
2. A toggle disconnect switch for cooling only units, or a door interlocking disconnect switch for fan coil units with electric heating coils. All disconnecting devices shall be sized and located as required to disconnect all ungrounded power conductors to all internal electrical components.

3. Individual overcurrent protection devices as required to protect individual units and transformers.

4. If there is a pressurized primary air source, the primary inlet shall be equipped with an inlet collar sized to fit the primary duct size shown on the drawings. Any transitions shall be provided and installed by the Division 15 mechanical subcontractor. The inlet collar shall provide at least a 6" length with a 1/8" high raised single or double bead located approximately 1 1/2" from the inlet connection. The primary and fan design cfm settings shall be clearly and permanently marked on the bottom of the unit along with the fan coil unit identification numbers. Each fan coil unit with a primary air inlet and damper shall incorporate a Nailor Diamond Flow sensor with four pick up points on each side to insure that with typical duct turbulence, the controller fidelity shall be +/- 5% of set volume even with a hard 90° elbow at the inlet. Static variation of 0.5" wg. to 6.0" wg. shall not affect the flow reading. Provide a transformer with 24 volt AC secondary to provide power for the unit's controls and the Division 17 controls. The VAV fan coil unit manufacturer and the Division 17 building controls subcontractor shall verify compatibility of the multi-point flow sensors with transducer and DDC microprocessor furnished under Division 17 prior to bidding this project.

5. The outlets shall be rectangular or round as required. Unit shall be designed to fit between the floor pedestals with no bridging required.

6. Fan motor assembly shall be a forward curved centrifugal fan with a direct drive motor. Motors shall be AO Smith or General Electric ECM and/or Nailor EPIC variable-speed DC brushless motors specifically designed for use with a single phase, (120, 208, 240 277) volt, 50 or 60 Hertz electrical input. Motor shall be complete with and operated by a single phase integrated controller/inverter that operates the wound stator and senses rotor position to electrically commutate the stator. All motors shall be designed for synchronous rotation. Motor rotor shall be permanent magnet type with near zero rotor losses. Motor shall have built-in soft start and slewed speed change ramps. Motor shall be able to be mounted with shaft in horizontal or vertical orientation. Motor shall be permanently lubricated with ball bearings. Motor shall be direct coupled to the blower. Motor shall maintain a minimum of 65% efficiency over its entire operating range. Provide isolation between fan motor assembly and unit casing in at least 4 locations to eliminate any vibration from the fan to the fan coil unit casing. Provide isolation between the motor and blower as well as between the blower and casing. Provide anti-back rotation system or provide a motor that is designed to overcome reverse rotation and not affect life expectancy.

- a. The manufacturer of the fan coil units shall set the fan discharge cfm at the factory. If the fan coil unit manufacturer cannot factory set the fan cfm, he shall send factory technicians to the field to adjust the GE ECM and/or Nailor EPIC motor and the associated controller/inverter to the discharge CFM indicated in the schedules in the contract documents. Fan cfm shall be constant within ± 5% regardless of changes in static upstream or downstream of the fan coil unit after it is installed in the field. Fan cfm is to be set with a potentiometer and digital meter. Neither SCR's nor rheostats shall be an acceptable means of setting the fan cfm. The fan coil unit manufacturer shall provide one speed adjustment device to the owner for field adjustment of the fan speed should construction or design changes become necessary.

Suggested Specifications • Underfloor Fan Coil Units • Model Series 38F

PART 2 – PRODUCTS

b. A witnessed test shall be conducted by the fan coil unit manufacturer in an independent testing laboratory to confirm that the fan coil unit and the fan motor as an assembly performs in accordance with this specification. If the fan coil unit and DC motor as an assembly fails to perform as specified and as scheduled on the drawings, the fan coil unit manufacturer shall make adjustments and take all corrective action as necessary at the fan coil unit manufacturer's sole expense.

7. The fan coil unit shall be listed in accordance with UL 1995 as a composite assembly consisting of the fan coil unit with or without the electric or hot water heating device and or chilled water cooling device.

8. Heating Options:

9. **If there is a pressurized primary air duct**, the fan coil unit shall be capable of operation as described herein with inlet static pressure of .05 at full cooling with no mixing of induced and primary air. [The sequence of operation should be described here if not part of the temperature controls specifications.] The primary air damper shall be of a design that shall vary primary air supply in response to [a pneumatic or an electronic] signal. Primary air damper close-off leakage shall not exceed 2% of the maximum ARI rated primary air cfm as shown in the manufacturer's catalog for each size fan coil unit at 3" w.g. inlet static pressure. Submit damper leakage test data to the engineer for review. Damper linkage and actuator shall be located inside the fan coil unit. Damper connection to the operating shaft shall be a positive mechanical through bolt connection to prevent any slippage. Provide non-lubricated Delrin or bronze oilite bearings for the damper shaft. The primary air damper in conjunction with the [pneumatic or analog electronic controller or DDC microprocessor] furnished under Division 17 shall be selected to provide accurate control at low primary air velocities. The total deviation in primary airflow shall not exceed $\pm 5\%$ of the primary air cfm corresponding to a 300 fpm air velocity through the primary air damper.

10. **If the unit incorporates a mixing chamber**, the mixing chamber shall provide mixing of primary air and plenum air from 100% primary air to 0% primary air. Mixing of the primary and secondary air streams shall be as described in paragraph 2.03 D. The deviation of fan supply air at design conditions and primary airflow rates from 100% primary air to 0% primary air shall not exceed 5%.

11. Provide duct inlet and outlet connections as indicated on the drawings.

12. All components, including all controls and wiring, shall be factory installed, except the room sensor or thermostat. No field assembly will be allowed. The unit shall be complete and suitable to accept the following field connections if required:

- a. Primary duct.
- b. Secondary duct.
- c. Single point electrical connection. See drawings for control box locations required for each fan coil unit.
- d. DDC controller control signals and wiring.
- e. Room sensor connection.

B. The fan coil unit shall be capable of operating throughout the full cataloged primary airflow range with an inlet static pressure of 0.10" w.g. or less. All downstream static pressure requirements are to be supplied by the fan coil unit internal fan. See the schedules on the contract documents for static pressure requirements.

C. The control sequence shall be as specified in Division 17.

D. Each size of each fan coil unit to be used on this project shall be completely laboratory tested for air performance and acoustics. The acceptability of the independent testing laboratory is subject to review by the owner, project acoustical consultant, and the engineer. The fan coil unit manufacturer shall submit complete details, brochures, instrumentation information, etc., for review. The laboratory shall be capable of properly testing the largest fan coil unit on this project. See paragraph 1.06 B for acoustic guidelines.

E. After the manufacturer has submitted certified copies of the laboratory air performance and acoustical performance test results to the engineer, the engineer may witness the laboratory tests to verify compliance with the Specifications. See Section 15 for additional submittal and certification requirements.

I. All fan coil units shall be identified on the top of the unit (minimum 1/2" high letters) and on the shipping carton, with the floor and box number that identifies it along with the CFM settings. Every unit shall have a unique number combination that matches numbers on the contractor's coordination drawings as to its location and capacity and is coordinated with the DDC controller and the Division 17 Building Control System submittal drawings.

J. The manufacturer will verify the operation of each unit before shipment. Testing shall include at least the following:

1. Apply electric power to the unit.
2. Start the fan and verify fan rotates properly.
3. The manufacturer shall factory or field adjust the GE ECM and/or Nailor EPIC motor and associated controller/inverter to the discharge CFM indicated in the schedules. (Refer to paragraph 2.03 A.2.e.1 hereinbefore.)
4. Energize the electric heat through the electric heating coil relay. Verify the signal with a voltmeter and ammeter to ensure proper heater operation.
5. De-energize the electric heating coil and verify the signal with a voltmeter to ensure the heater is de-energized.
6. If DDC controls are mounted, disconnect the primary air damper actuator from the DDC fan coil unit controller. Provide separate power source to the actuator to verify operation and rotation of damper. Drive the damper closed and verify by feel or observation that damper is driven fully closed. Return primary air damper to the fully open position prior to shipment.
7. Provide a written inspection report for each fan coil unit signed and dated by the factory test technician verifying all fan coil unit wiring and testing has been performed per the manufacturer's testing and quality assurance requirements.



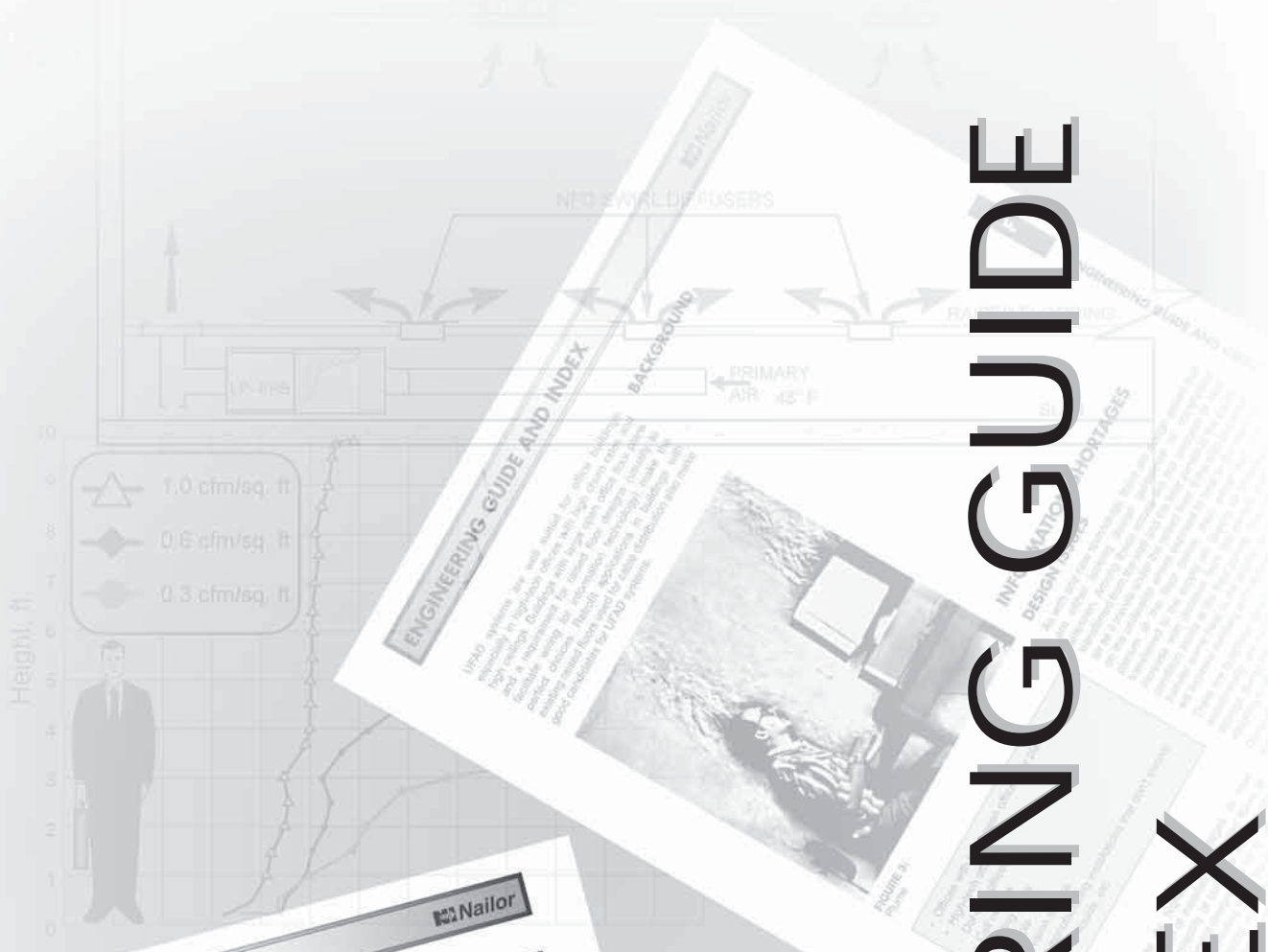

ENGINEERING GUIDE AND INDEX

UFAD systems are well suited for office buildings with high ceilings. Buildings with high ceilings can take advantage of the large volume of air that can be distributed through the raised floor system. This air can be used for heating, cooling, and humidity control. The large volume of air also allows for more efficient air distribution and lower fan static pressures. This results in lower energy costs and lower maintenance costs. For information on UFAD systems, please contact your local Nailor representative or visit our website at www.nailor.com.



ENGINEERING GUIDE AND INDEX

Addition of Raised Floor System		Further Addition of UFAD System	
Typical Cost Adds	Typical Cost Reductions	Typical Cost Adds	Typical Cost Reductions
Utility Costs:	Utility Costs:	Utility Costs:	Utility Costs:
Maintenance/Operation Costs:	Maintenance/Operation Costs:	Maintenance/Operation Costs:	Maintenance/Operation Costs:
Cash Flow Related Intangibles:	Cash Flow Related Intangibles:	Cash Flow Related Intangibles:	Cash Flow Related Intangibles:

TABLE 2: Total Cost Reductions for the Addition of Raised Floor and UFAD Systems: First Costs (UFAD Design Guide)



ENGINEERING GUIDE AND INDEX

Contents

	Page No.
Introduction	F3
Green Buildings	F3
Advantages of Underfloor Air Distribution Systems	F4
Enhanced Ventilation Effectiveness • Improved Indoor Air Quality • Energy Efficiency • Enhanced Comfort Levels • Thermal Storage • Reduced Energy Use • Individual Control • VAV Control • Reduced Life Cycle Costs • Reduced Building Costs • Recycled Materials	
Disadvantages of Underfloor Air Distribution Systems	F5
Unfamiliarity • Lack of Design Guidelines • Not All Diffusers are the Same • Architectural Layouts • New Technology • Floor Leakage and Spills	
Applications	F5
Retrofit	
Information Shortages	F7
Design Issues	
Design Considerations	F8
Room Air Stratification Design • Temperature Gradient • Supply Air Temperatures • Load Calculations • Code and Standard Issues • Condensation and Dehumidification • Configuration • Interior Zones • Perimeter Zones • Acoustic Performance • Control Strategies	
Underfloor Plenum Design	F11
Thermal Decay • Obstructions Within the Plenum • Air Leakage • Structural Strength of the Raised Floor • Cleaning	
Equipment Options	F12
Perimeter Zones	F12
Fan Coils • VAV or Fan Powered VAV Terminal Units	
Conference Rooms	F16
VAV Fan Coils or Fan Powered Terminal Units • VAV Diffusers	
Cost Issues	F17
Standards, Codes and Ratings	F19
ANSI/ASHRAE Standard 55-1992 • ANSI/ASHRAE Standard 62-2001 • ANSI/ASHRAE/IESNA Standard 90-1 2001 • ANSI/ASHRAE Standard 113-1990 • ASHRAE Standard 129-1997 • Title 24 • NFPA 90A • Uniform Building and Other Applicable Codes • LEED	
Design Issues	F20
Floor Heights • Underfloor Plenum Heights • Space Cooling and Heating Loads • Locations of Floor Diffusers	
Useful Formulae and Definitions	F22
Imperial Metric Guide Conversion Factors	F23
Pressure Measurement	F24
Conversion Chart for Converting Velocity Pressure	F25
Index	F26

Introduction

The number one occupant complaint in modern commercial buildings is thermal comfort. This results in loss of productivity and increased absenteeism by the occupants as well as generally reduced energy efficiency as fans and space heaters clutter the office environment. Employee salaries typically account for over 90% of the operating cost of a modern commercial building, therefore anything that will enhance employee productivity and reduce absenteeism such as increased comfort levels and better air quality can create immense financial benefits. The same is true for retail spaces where increased sales are associated with increased comfort conditions.

As engineers, the design goal is to achieve superior comfort levels for the occupants without sacrificing energy efficiency and dramatically increasing the first cost of the project. One of the main problems associated with achieving this goal is that people in a modern office building tend to be a rather diverse group with different perceptions and requirements. The typical air distribution systems do not accommodate this flexibility well as large portions of modern buildings are now being devoted to open plan offices. The customary highly mixed overhead air distribution systems will provide a uniform environment in the space. This does not however maximize occupant comfort levels, as some people will feel warm as others feel cool at the same conditions. They will also dress differently, especially at different times of the year, and may have different levels of activity throughout the day or depending on their occupations. This diversity in occupant requirements poses an incredible challenge for the air distribution design, which must be very flexible to accommodate the varying situations and preferences. One of the best ways to achieve this flexibility is an underfloor air distribution system with individually adjustable diffusers or with thermostatically controlled diffusers. This allows individuals to set their own preferences and maximize their comfort conditions. (An interesting study showed that people were much more satisfied in an environment that they had some control over, even if they never actually made an adjustment. Just having the ability to adjust the temperature or air velocity will increase occupant comfort levels.)

Underfloor air distribution systems are a relatively new concept in North America. Developed as an improvement over displacement ventilation systems, the moderate amount of mixing in the occupied zone improves comfort conditions while still allowing energy efficient stratification in the unoccupied zones. Used for many years in Europe and Japan they are now gaining popularity as an energy efficient 'green' design method and a personal comfort solution. The use of raised floor systems for the routing of electrical, telephone and computer cabling has provided the financial conditions necessary for widespread implementation of this technology.

The energy savings from the air distribution system alone, even with the elimination of much of the ductwork, generally will not offset the first costs associated with raised floor systems. However when combined with the life cycle savings associated with high churn rates (office layout changes) and the electrical, telephone and computer wiring changes necessary, not to mention improved occupant comfort they are rapidly becoming the systems of choice in modern office buildings.

Green Buildings

An evolving industry trend is toward environmentally friendly, energy efficient, "green" buildings. A variety of new and revised guidelines and incentive programs are being developed to encourage this development, some are even becoming standards for certain regions, federal agencies, state, provincial and municipal governments. These include the use of rating systems such as LEED, Green Leaf Eco-Rating Program, BREEAM Green Leaf and GBC/GBTool.

The LEED (Leadership in Energy and Environmental Design) Green Building Rating System is currently the most widely accepted in North America and is the result of efforts by the U.S. Green Building Council (USGBC) to provide a national standard for what constitutes a green building. This effort has been expanded into many other countries including Canada with the founding of the Canada Green Building Council (CaGBC) and the World Green Building Council.

The LEED rating system assigns a point value to various credit categories. These points are then combined to determine the overall building rating (Certified, Silver, Gold or Platinum). These categories include sustainable sites, water efficiency, energy and atmosphere, materials and resources, indoor environmental quality and innovation and design process. Information on the program is available from the USGBC website at www.usgbc.org.

Sections of particular interest to HVAC engineers include:

- Commissioning requirements
- Additional commissioning requirements
- Minimum energy performance (must meet ANSI/ASHRAE/IESNA Standard 90.1 or local energy code whichever is more stringent)
- Optimize energy performance (points awarded for energy reductions over minimum requirements using the Energy Cost Budget Method of Standard 90.1) (ASHRAE is also currently developing Advanced Energy Efficiency Guidelines for 30%, 50% and 75% reductions)
- CFC reduction in HVAC&R equipment (zero use of CFC-based refrigerants)
- Ozone protection (use of HVAC&R equipment that does not contain HCFCs)

- Measurement and verification (install continuous metering for equipment such as constant and variable motor loads, variable frequency drives, chiller efficiency, cooling load, air and water economizer and heat recovery cycles, air distribution static pressures and ventilation air volumes, boiler efficiencies...)

- Regional materials (use 20% of building materials and products that are manufactured regionally within a radius of 500 miles)

- Regional materials (of the regional materials above use a minimum of 50% that are extracted, harvested or recovered within 500 miles)

- Environmental quality (IAQ) (meet minimum requirements of ASHRAE Standard 62 using the ventilation rate procedure)

- Environmental tobacco smoke control

- Carbon dioxide monitoring (integrated with BAS)

- Ventilation Effectiveness (design ventilations system to result in air change effectiveness values greater or equal to 0.9 as determined by ASHRAE 129-1997)

- Construction IAQ management plan - during construction (follow SMACNA IAQ guideline, MERV 8 filters on return grilles etc...)

- Construction IAQ management plan - before occupancy (flush building for 2 weeks with 100% outdoor air and MERV 13 filtration or conduct testing procedure consistent with EPA protocol)

- Indoor chemical and pollutant source control (negative pressure and exhaust requirements for housekeeping areas and copy/printing rooms)

- Controllability of systems (provide controls for each individual for airflow, temperature and lighting for at least 50% of the occupants in non-perimeter, regularly occupied areas)

- Thermal comfort (comply with ASHRAE Standard 55 for thermal comfort and humidity conditions)

- Thermal comfort permanent monitoring system (temperature and humidity monitoring to ensure compliance with ASHRAE Standard 55)

- LEED accredited professional (at least one principal participant of the project team to successfully complete the LEED Accredited Professional exam)

Advantages of Underfloor Air Distribution Systems

Enhanced Ventilation Effectiveness

Underfloor air distribution can enhance ventilation effectiveness. Air movement from floor to ceiling efficiently removes heat and contaminants. Since very high air change effectiveness values can be achieved this contributes to LEED Rating.

Improved Indoor Air Quality

Air quality for the occupants is improved as airborne pollutants tend to rise out of the occupied zone with the thermal plumes from people and equipment. Since the air makes a single pass by the occupant and is not mixed back into the lower homogenous zone, occupants enjoy more healthy environments. With floor 'swirl' diffusers, ventilation air is delivered and mixed in the breathing zone, which reduces the concentration of contaminants.

Energy Efficiency

Well designed systems can be more energy efficient than conventional overhead systems. Operational static pressures are generally much lower, reducing fan energy use. This also contributes to the LEED Rating. Thermal plumes created by people and equipment are returned directly to the air handler; therefore, actual room load may be reduced resulting in less actual airflow required into the room which reduces the number of diffusers and fan sizes saving costs and energy. Some of these convective loads from lights, windows, computers and people are returned directly to the central system and are not fully included in the room air side load.

Enhanced Comfort Levels

Higher supply air temperatures enhance occupant comfort levels reducing drafts and improving thermal comfort.

Thermal Storage

Thermal storage in the structure and concrete slab may be used to save energy and reduce peak cooling loads.

Reduced Energy Use

Higher supply air temperatures will increase the economizer hours for dry climates. This increases the system COP.

Individual Control

Individual control of air outlets enhances occupant comfort levels and increases employee productivity. Both manual and automatic systems are available. These options contribute to LEED Rating.

VAV Control

Automatic controls for air outlets are available to provide variable air volume temperature control and monitoring to ensure thermal comfort of occupants. This also tends to supply ventilation air to the specific area it is required enhancing air movement and air quality in the occupied areas. This contributes to LEED Rating.

Reduced Life Cycle Costs

Use of raised access floor systems can significantly reduce life cycle costs for buildings with high churn rates. Diffuser locations can be easily changed to accommodate revised floor layouts without involving interior contractors.

Reduced Building Costs

Building costs may be reduced due to lower floor to floor heights and reduced or eliminated ceiling plenums.

Recycled Materials

Products such as the Nailor ANFD floor swirl diffuser utilize 100% recycled aluminum, which helps to protect our environment and contributes to LEED Rating.

Disadvantages of Underfloor Air Distribution Systems

Unfamiliarity

Building occupants often don't know they can easily adjust the floor diffusers to improve their thermal comfort

Lack of Design Guidelines

It is possible that at very low airflow conditions and low supply air temperatures the stratification levels in the room will lead to uncomfortable temperature variations. Constant volume variable temperature systems will eliminate this rather unlikely condition, as will fixed minimum airflows on variable volume systems.

Not All Diffusers are the Same

At high airflow conditions, some diffusers will cause the room to approach a well-mixed system eliminating some of the energy benefits associated with thermal stratification.

Architectural Layouts

Diffusers must be located and/or relocated so as not to interfere with occupant positions and furniture placement. Clear zones must be established around individual diffusers as locally high velocities and low temperatures will create regions unsuitable for long-term occupancy.

New Technology

UFAD, while rapidly gaining acceptance, is still widely considered to be an unknown and unproven technology, despite the thousands of installations. This lack of understanding, experience and acceptance can result in possible problems with construction trades, project managers, code officials and building operators.

Floor Leakage and Spills

Transitioning access floor installations into areas such as washrooms, kitchens and lunchrooms can pose challenges requiring the use of waterproof membranes on top of the floor and difficulty in diffuser placement. (Plumbing costs may be reduced to help offset this).

Applications

There are three primary methods of room air distribution, conventional overhead mixing systems, displacement ventilation and underfloor systems. The conventional overhead mixing systems have been widely applied in North American buildings and are familiar to most people. Briefly, they consist of ceiling supply diffusers and ceiling return diffusers. Supply air is introduced into the room through these ceiling mounted diffusers at a relatively high velocity where it is directed across the ceiling. Due to the velocity of the air, it rapidly entrains room air causing the supply jet to rapidly approach room temperature and to slow to a lower more comfortable velocity before entering the occupied zone. This system works very well in most interior zone applications for both heating and cooling conditions and provides a well-mixed comfortable environment throughout the space without excessive drafts or local temperature variations. This is also the major drawback as the well-mixed space temperatures and velocities will only satisfy the majority of the occupants and will typically not allow for individual adjustments and comfort preferences.

Displacement ventilation systems, (see Figure 1), supply low velocity conditioned air through large low velocity diffusers located generally at a low sidewall location. As this air is supplied directly into the occupied zone, it must be at very low velocities and at temperatures approaching room temperature to maintain a comfortable environment. These systems have many drawbacks that tend to eliminate their selection in a modern office environment; however, in areas with high ceilings and high heat loads (i.e. manufacturing facilities) they can be ideal. In an office environment, the increased supply air temperatures will require large volumes of air (increased fan energy and humidity control problems), necessitating large diffuser and wall areas. As this large volume of air flows into the room it settles across the floor until it is entrained by thermal plumes (see Figure 2 & 3), from heat sources in the room. These plumes will create a stratification layer in the room with a height dependent on supply air quantity, temperature, the height and magnitude of the heat sources and overall room load. This stratification height is difficult to control in all circumstances and could lead to uncomfortable conditions due to excessive temperature differences and result in poor comfort conditions in the occupied zone. Heating conditions can also be very challenging, especially in areas with high ceilings, as the stratification levels will cause zones with stagnant airflow and also lead to short circuiting of supply air. It also has the same drawback as overhead systems as it does not allow for individual adjustments and it is even more difficult to create individual zones.

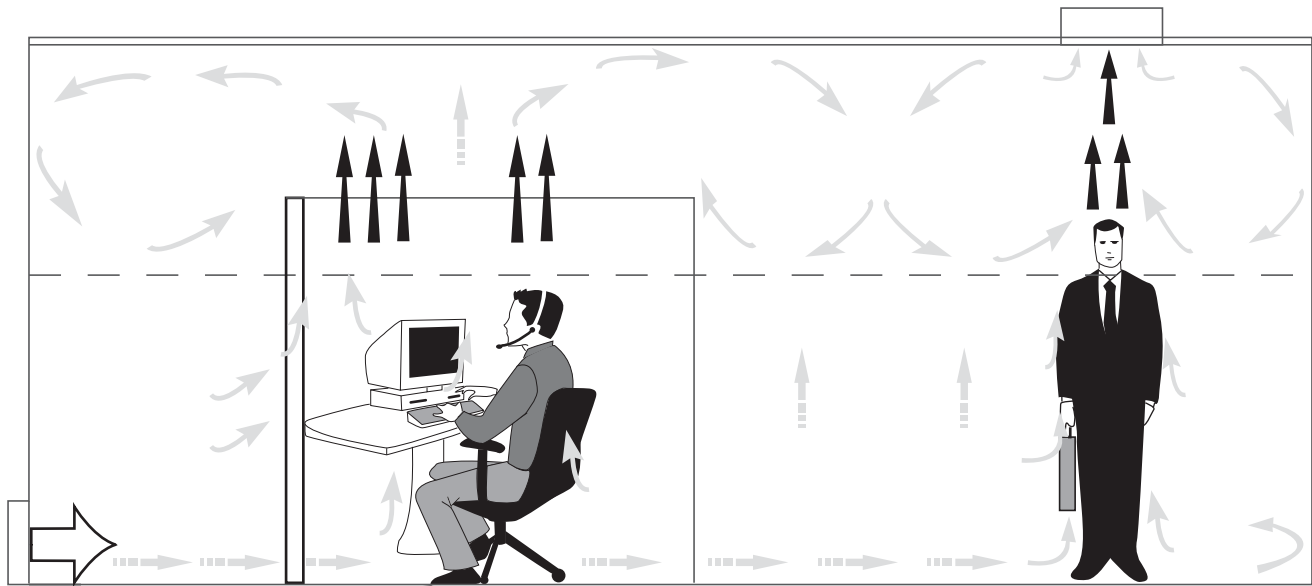

Figure 1:
Displacement Ventilation Room



Figure 2:
Hybrid System

UFAD systems, (see Figure 2), are basically a hybrid of these two concepts. Supply air is introduced directly into the occupied zone through specially designed floor diffusers. These floor diffusers are engineered to rapidly mix supply and room air in the occupied zone and create a generally well-mixed environment maximizing comfort conditions while allowing a larger cooling load to be handled than typical displacement ventilation systems. Above the occupied zone, the thermal plumes (see Figure

3), from people and equipment create a stratification layer. The rapid mixing by the supply diffusers allows a supply air temperature to be used that is generally cooler than displacement ventilation however not quite as cool as overhead systems. The diffusers themselves are all individually adjustable either manually or automatically and allow individual control of the local environment for the occupants. This enhanced comfort level is one of the primary benefits of this concept.

UFAD systems are well suited for office buildings, especially in high-tech offices with high churn rates and high ceilings. Buildings with large open office floor plans and a requirement for raised floor designs (usually to facilitate wiring for information technology) make the perfect choices. Retrofit applications in buildings with existing raised floors used for cable distribution also make good candidates for UFAD systems.



Figure 3:
Thermal Plume

- Offices with large open office floor plans
- High-tech offices
- Dot-com offices
- Call centers
- Trading floors
- Schools
- Television studios
- Light manufacturing installations that don't involve spillage of liquids, etc.

Retrofit

UFAD design has its highest advantages in new construction. The option of installation of raised floors is restricted in a large majority of buildings due to limited floor to floor heights. Current designs use 12" to 18" (.3 to .46 m) high floors, and difficulties fitting the raised floors into the existing floor spacing and satisfying occupant requirements range from moderate to impossible.

Information Shortages

Design Issues

As with any new technology, there are design issues that are either lacking design guidelines or completely unknown. Among these issues are the amounts of heat transferred from the slab and the floor panels to the supply air as it travels under the raised floor. If the slab is warmer on the underside where exposed to heat in the return air plenum of the floor below, then some heat will be transferred to the supply air. Supply air temperature will increase with distance from the plenum inlet. A similar condition exists at the floor panels. The warmer room will transfer some heat to the supply air in the plenum and it will increase similarly with distance from the inlet.

There are questions raised as to whether the slab can be economically pre-cooled at night and used for thermal storage during the occupied hours. There are few studies attesting to the benefit of this control strategy.

Questions surrounding the impact of UFAD diffusers on room stratification, ventilation effectiveness, ventilation efficiencies, behavior of thermal plumes at solar heated windows, interaction between thermal plumes and varying airflows, and health and comfort benefits still have to be answered by ASHRAE and other research groups.

UFAD systems are ideal for areas with high ceilings as they provide air directly into the occupied zones.

Design Considerations

Room Air Stratification Design

An understanding of controlled and optimized thermal stratification is critical to the increasing use of these systems; however, there is a critical lack of sound test data from which a guideline and design tools for calculating the energy needs and air distribution requirements on UFAD systems. We need answers to questions such as, "What portion of the convective heat sources are contained in thermal plumes and can be neglected as space load or room cooling air quantity? What are the effects of supply air flow, supply air temperature, ceiling height, and cooling air quantity on room stratification?"

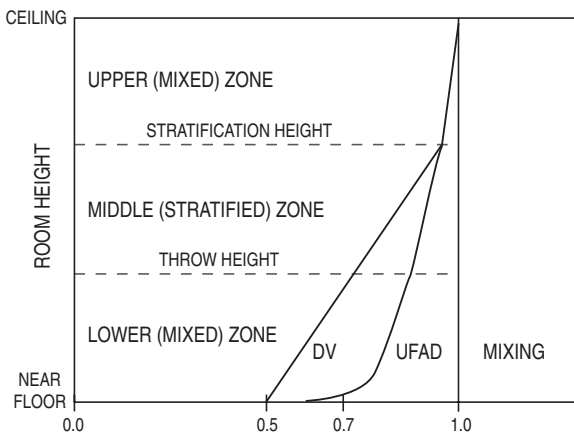

Temperature $[(T - T_s) / (T_e - T_s)]$

Figure 4:

Comparison of typical vertical temperature profiles for underfloor air distribution, displacement ventilation, and mixing systems.

Temperature Gradient

The room comfort levels are very dependent on the type of diffuser used. The general plan is to establish a thermocline in the room at a stratified height that includes the head height of the average occupant. (see Figure 4) In the case where the average occupant is seated, the stratification height would be about 4.5' (1.4 m) above the floor. In the case where the average occupant is standing, the height would be about 6' (1.8 m) above the floor. The lower zone will always exist, and the height is set by the vertical air projection of the floor diffusers and the ratio of the space heat load to the supply airflow to the space. The air below the thermocline should be a fairly homogenous mixture with near constant temperature. This is achieved by the high mixing performance and high induction rate of the swirl diffusers.

The air above the thermocline is stratified and acts similar to the air in a pure displacement type system. This zone does not always exist. If the vertical air projection from the diffusers is too high, this zone is completely eliminated and the entire room becomes a dilution system where all the air is mixed like in an overhead system. When the second zone does exist, thermal plumes are active in this area carrying heat, contaminants and humidity to the boundary layer near the ceiling where air is returned to the air handler. Temperature is not constant. Outside the plumes, it rises gradually as shown in Figure 5.

Above the stratification layer is an upper mixed zone or boundary layer very near the ceiling. In this boundary layer, the air is nearly constant in temperature and composed of warm, contaminated air. If jets from the diffusers penetrate into this zone, it may cease to exist. When this zone is disturbed by the diffuser jets, heat and pollutants are returned to the occupied space.

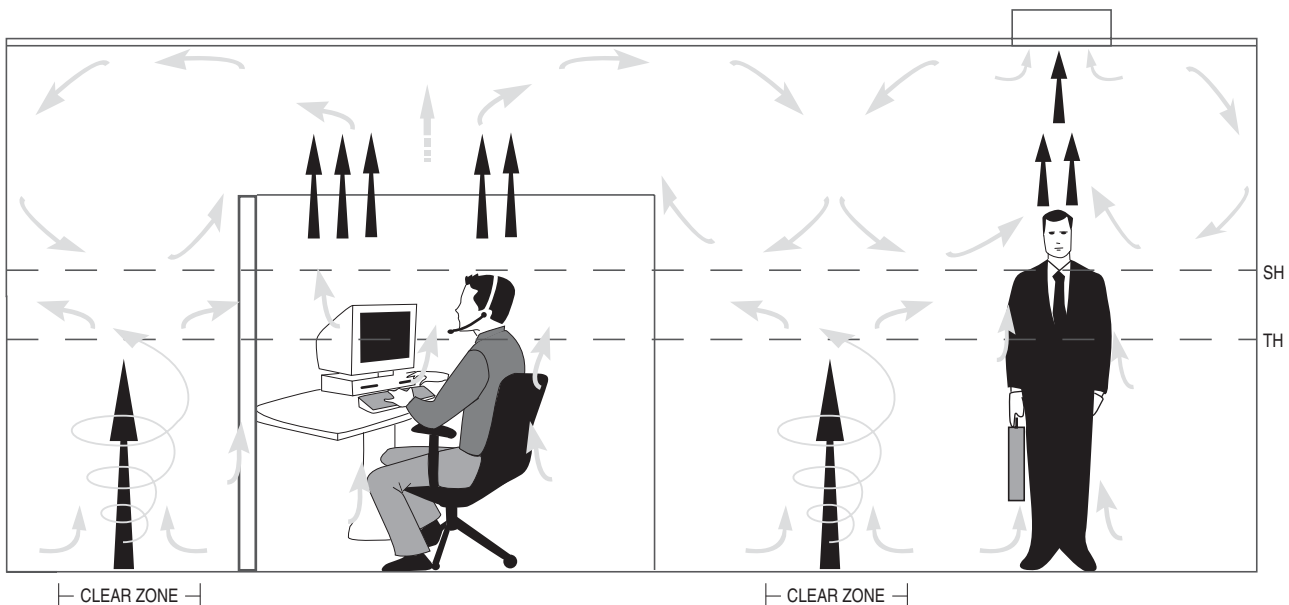

Figure 5:

Underfloor air distribution system with diffuser throw below the stratification height.

Supply Air Temperatures

Minimum supply air temperatures should be maintained in the range of 61 to 65° F (16 to 18° C). Temperatures cooler than this can chill people's feet, even through the soles on their shoes. These low temperatures can also cause chills to an occupant located near a diffuser. Supply air temperature reset control methods is preferable to constant SAT control strategies; however, be prepared for slow changes in room conditions as SAT changes due to the mass of the slab that acts as a heat sink. One method of controlling SAT is to control off of the return air temperature in the return air plenum. This will maintain the thermocline at the desired location, thus maintaining optimum space comfort and minimum energy expended, regardless of the space loading.

Load Calculations

In properly designed systems, convective heat loads above the stratification levels in the occupied zone will not enter the occupied zone, but rather rise through the second zone to the third and return to the air handler. As such, these loads are not room loads.

Code and Standard Issues

UFAD systems are still a new technology in our industry. As such, it is not well covered by local codes or recognized standards and authorities. ASHRAE Standards 55, 62.1 and 113 all have direct relevance to UFAD systems, yet none of them directly addresses UFAD, and Standard 113 does not address UFAD at all. Future revisions to those standards will correct some or all of the deficiencies; however, in the mean time, coordination with local fire and building codes and local code authorities should be sought early in the design process. Arguments can be made that fundamentally, the floor plenum should follow the same codes that cover ceiling plenums.

Condensation and Dehumidification

Humid climates will need more dehumidification than drier climates; consequently, there will not be as many economizer days in the humid climates. Days when the outdoor air temperatures are above 55°F. (12.8°C.) will usually require some design to provide dehumidification to the space, whereas in drier climates, days when temperatures are below 65°F. (18.3°C.) outdoor air may be acceptable as cooling air without further dehumidification. Depending on the local climate more economizer days may be available to improve energy efficiency as well as increased chiller COP, which contributes to LEED rating.

Configuration

One difference between overhead and underfloor systems is that the UFAD systems are usually configured to have a larger number of smaller capacity outlets. Floor diffusers are usually in close proximity to the occupants. The close proximity to the occupant optimizes the occupant's ability to adjust the airflow from the diffuser to fit his personal requirements. Floor manufacturers normally supply floor tiles with precut holes for diffusers, power/voice/data terminals and any other outlet boxes; therefore, it is imperative to decide on the diffuser and other outlet selections prior to ordering the floor tiles.

Interior Zones

Interior zones are typically cooling only zones and do not require heat. Normally they are served with about 0.6 cfm/ft² (3 L/s/m²) per diffuser. Occupant satisfaction is maximized if the open office diffusers are designed to be manually adjusted to fit the desires of the local occupant. However, conference rooms, training rooms and any other areas that are enclosed and subject to varying heat loads should be served with VAV diffusers. VAV diffusers should have modulating actuators rather than 3 point floating devices to keep all the actuators in one zone synchronized. Actuators with 3 point floating control will become lost during the day and have to be recalibrated or zeroed regularly.

Perimeter Zones

Perimeter zones have both heating and cooling loads. The loads are also much more variable than the interior loads as heat gains or losses at the curtain wall dictate the system requirements. VAV strategy of some sort is preferred for the perimeter zones. Usually, the perimeter zones and interior zones are separated under the floor. In this configuration, different SAT strategies can be utilized. Variable temperature and variable volume supply air works best in this application. Care must be taken to insure that the perimeter diffusers do not have long throws. The diffusers should be designed with throws that have no more vertical projection than the interior diffusers, about 4.5' (1.4 m) to about 6' (1.8 m) above the floor on a neutral wall. This will keep the perimeter diffusers from affecting the thermocline in the occupied space and mixing heat and pollutants back into the room.

Acoustic Performance

Radiated sound from equipment such as fan coils or fan powered VAV terminal units that may be located below the floor will be less than if similar equipment were mounted overhead with a conventional ceiling. Radiated sound can easily penetrate a lay-in ceiling, but penetrating steel and concrete panels is tough. Radiated attenuation is probably twice that expected from a single layer of gypsum board as laid out in ARI 885. Discharge sound can be a problem. In overhead systems, duct runs are usually fairly long providing a large amount of attenuation. In underfloor applications, the reverse is true, short runs and little attenuation. Units that are inserted directly into the septum separating the interior and perimeter zones will have almost no attenuation between the unit and the discharge grilles at the perimeter. When fan powered VAV terminals or fan coils are applied, they should have silencers or at least internally lined duct runs downstream for attenuation. It has become popular to use units with 1000 cfm or more at the terminal unit. Airflows from these types of equipment in this range are noisy if not attenuated.

F

ENGINEERING GUIDE AND INDEX

Control Strategies

Controlling the height of the thermocline in the space is of utmost importance for comfort and energy consumption. General guidelines would suggest that a reasonable target is about 0.6 cfm/ft² (3 L/s/m²). See Figures 6 and 7. As you can see from Figure 7, resetting supply air temperature in combination with adjusting room airflows is advisable to achieve optimal room conditions throughout the occupied zone. Note that the space thermostats may not be set the same as with overhead systems. The temperature should be set to maintain the thermocline and occupant comfort. The temperature gradient in the occupied space should be no more than 5°F. (2.8°C) (from ankle to neck) to maximize comfort, while the temperature gradient from the supply air to the return air should be 20°F. (11°C) to minimize energy use. Comfort can be achieved while destroying the stratification layer if the room is oversupplied with air. Sensor height is important. If the sensor is near or above the thermocline, it should read higher than the occupied zone temperature. See Figure 8 for a description of different temperature profiles based on different airflows. The graphs in Figure 8 are not measured data, but rather illustrations shown for demonstration purposes only.

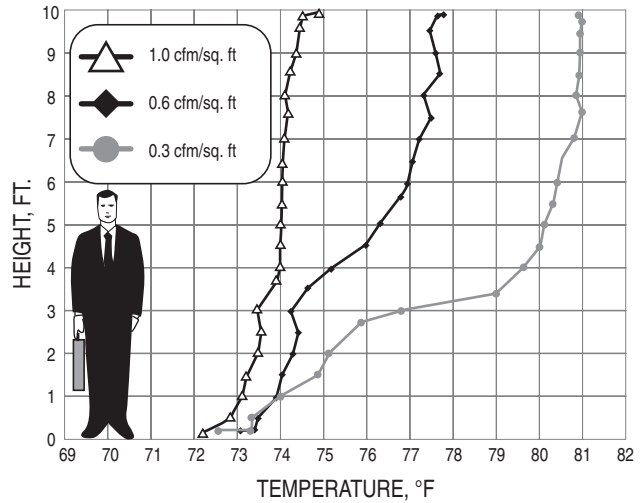

Figure 6: Effect of room airflow variation at constant heat input, swirl diffusers, interior zone.

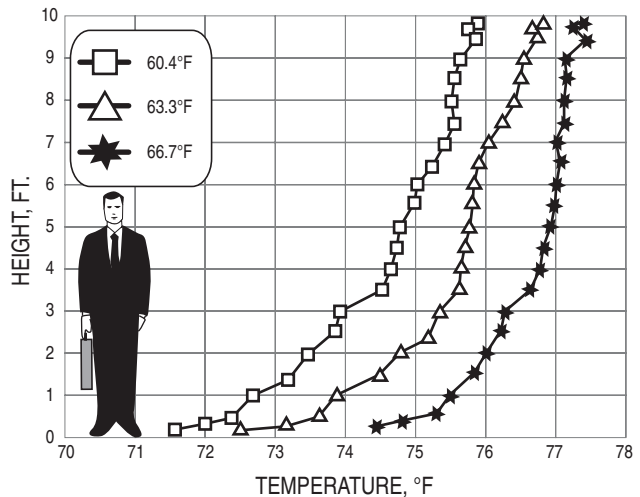

Figure 7: Effect of supply air temperature variation at constant heat input, interior zone.

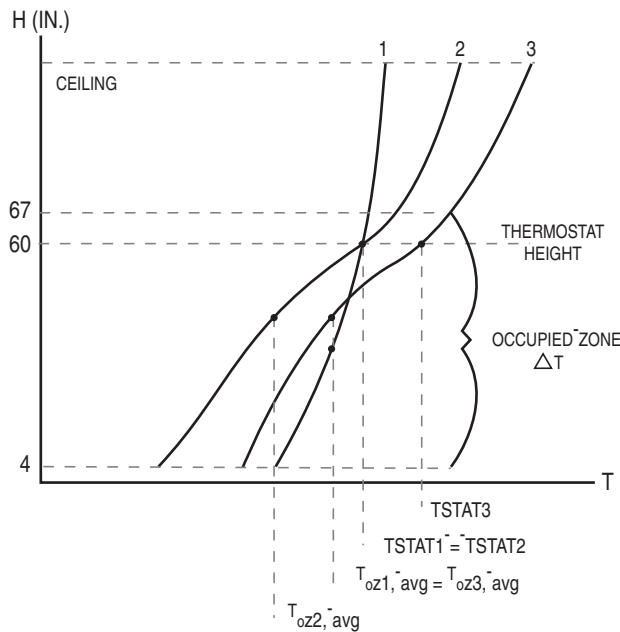

Figure 8:
Example sequence for controlling thermal stratification.

Underfloor Plenum Design

Thermal Decay

Airflow under the floor is different from airflow through overhead ducts that are insulated. The air in the floor plenum is in contact with the underside of the raised floor and the top of the concrete slab below. If the slab is warmer on the underside where exposed to heat in the return air plenum of the floor below, then some heat will be transferred to the supply air. Supply air temperature will increase with distance from the plenum inlet. A similar condition exists at the floor panels. The warmer room will transfer some heat to the supply air in the plenum and it will increase similarly with distance from the inlet. While additional research is needed to provide acceptable guidelines, some current designers suggest calculating a 0.05 to 0.15° F. (0.1 to 0.3° C) temperature rise per linear foot traveled by the air from the inlet to the outlet. This results in a maximum throw distance under the floor of 50 to 60 ft. (15 to 18 m) for typical applications. Horizontal ducts and air highways may be used to bridge distances between inlets and outlets; however, velocities in the ducts should be limited to 1200 to 1500 fpm (6 to 7.5 m/s). Outlets can be located all along the length of the duct, but outlet velocities should be limited to 800 to 1000 fpm (4 to 5 m/s). Balancing dampers should be considered for optimum control of airflow.

Obstructions Within the Plenum

Care should be taken to plan, coordinate and control the placement of cable trays and ducts below the floor. Stacking anything to close proximity to the floor tiles will obstruct airflow through the plenum.

Air Leakage

Plenum pressures in UFAD systems should run between 0.3 and 0.8 in. w.g. (0.07 to 0.2 pa) for normal operation. Even at these low pressures, leakage is an issue that must be considered. Leakage occurs between the floor panels and around walls if the panels are not sealed well. Leakage rates of 10 to 30% due to construction issues are normal. Leakage rates between the floor panels with different carpet tile configurations are shown in Table 1. As you can see, the method or pattern used for laying carpet on the floor tiles has a significant effect on the leakage. Use caution in oversizing the air supply to the room; air loss from between the tiles plus the heat loss through the floor can supply a large part of the cooling requirement at low load conditions. This could move the thermocline upwards using more energy and causing the room to be uncomfortable.

Plenum Pressure (in. H ₂ O [Pa])*	Carpet Tile Configuration		
	None	Aligned	Offset
0.05 [12.5]*	.68 [3.5]	.29 [1.5]	.14 [0.7]
0.1 [25]**	.96 [4.9]	.41 [2.1]	.20 [1.0]

Table 1:
Air Leakage Through Gaps Between Floor Panels
(cfm/ft²) [L/(s·m²)]

Structural Strength of the Raised Floor

There is no current standard for testing structural integrity of the raised floors in use today. However, most are engineered to meet the concentrated uniform and rolling loads experienced in a typical workplace environment. Of issue is whether the plastic floor diffusers also meet these requirements. There have been some instances where the mounting rings did not hold up under constant use in heavy traffic. Today, there are some manufacturers who advertise fire-rated plastic diffusers. They fall in 3 categories: fire-rated plastic parts, non-fire-rated plastic parts protected by a metal enclosure, and fire-rated metal parts. The fire-rated plastics tend to be more brittle than the original non-fire-rated parts. The brittleness degrades the structural integrity of the diffuser, but more importantly, causes the mounting rings to break easily. Until and unless more plastic, less brittle, fire-rated plastics are developed, these should be avoided for use in floors where people may walk or sit. The non-fire-rated plastic diffusers with metal enclosures can be very difficult to install. The enclosures have to be mounted to the bottom of the floor tiles. These are normally irregular surfaces and sealing poses a great problem. Nailor Industries is the only manufacturer of cast aluminum, fully fire-rated floor diffuser parts for easy installation and safe sturdy operation.

Cleaning

Prior to the installation of the raised floor, the slab should be thoroughly cleaned and sealed. Cleaning the plenum at the end of construction is absolutely required. Regular cleaning on an annual basis along with local cleanup during plenum reconfiguration should suffice after occupation of the building. If some sort of a chemical spill or accident or fire causes plenum contamination, the accessibility of the underfloor plenum makes the process much simpler and more effective as compared to an overhead plenum.

Equipment Options

Perimeter Zones

Fan Coils

Since the perimeter zone has both a heating and a cooling requirement, 2-pipe or 4-pipe fan coils may be selected for perimeter equipment. Nailor's 38F units fit nicely between the floor pedestals and provide a variety of airflow ranges to satisfy any job requirement. Care must be taken in design to address noise issues with this equipment because the discharge fan noise may be exposed directly to the room with very little attenuation. Fan coils can be arranged for either constant volume air delivery or VAV delivery. Obviously, the VAV option is much more energy efficient. Primary air can be taken directly from the underfloor plenum or it can be ducted from above the floor in a heating mode. Some typical layouts are shown in Figures 9 through 14.

Fan coils can also be mounted in the ceiling return air plenum in the perimeter zone. They can be configured to take air directly from the return plenum in both the heating and cooling load reducing or eliminating the need for supply air ducts. See Figure 11.

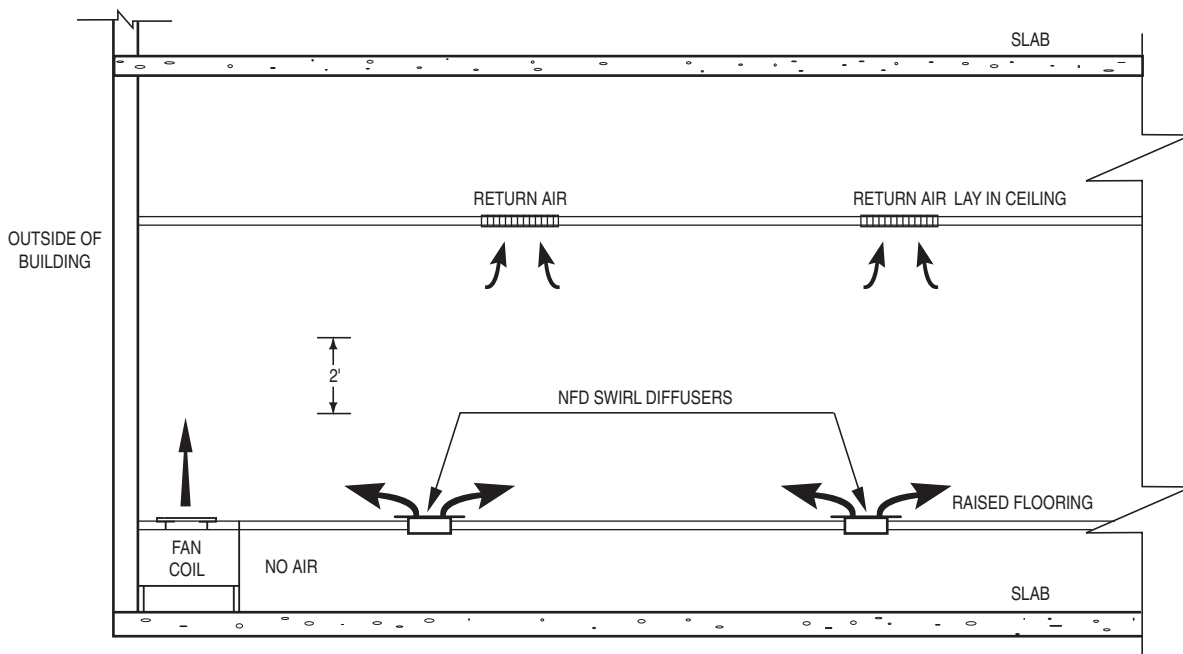

Figure 9:
Underfloor non-ducted fan coil

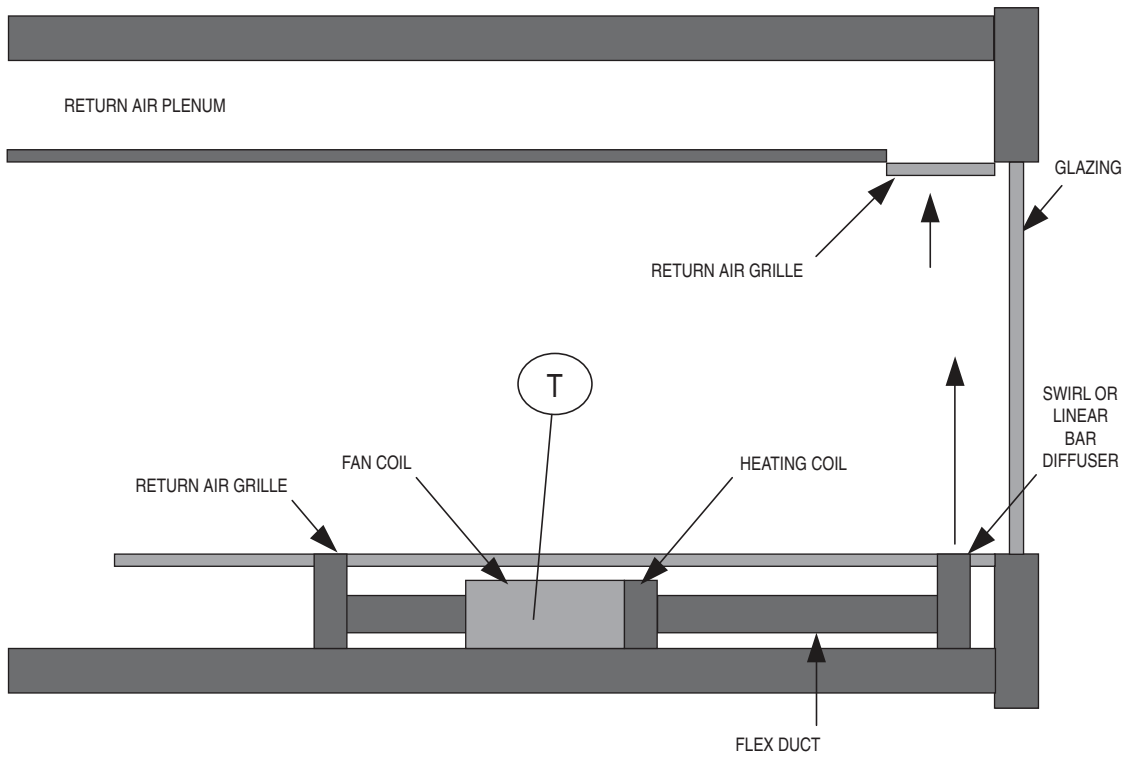

Figure 10:
Underfloor ducted fan coil

Fan coils can also be mounted in the ceiling return air plenum in the perimeter zone. They can be configured to take air directly from the return plenum in both the heating

and cooling load reducing or eliminating the need for supply air ducts. See Figure 11.

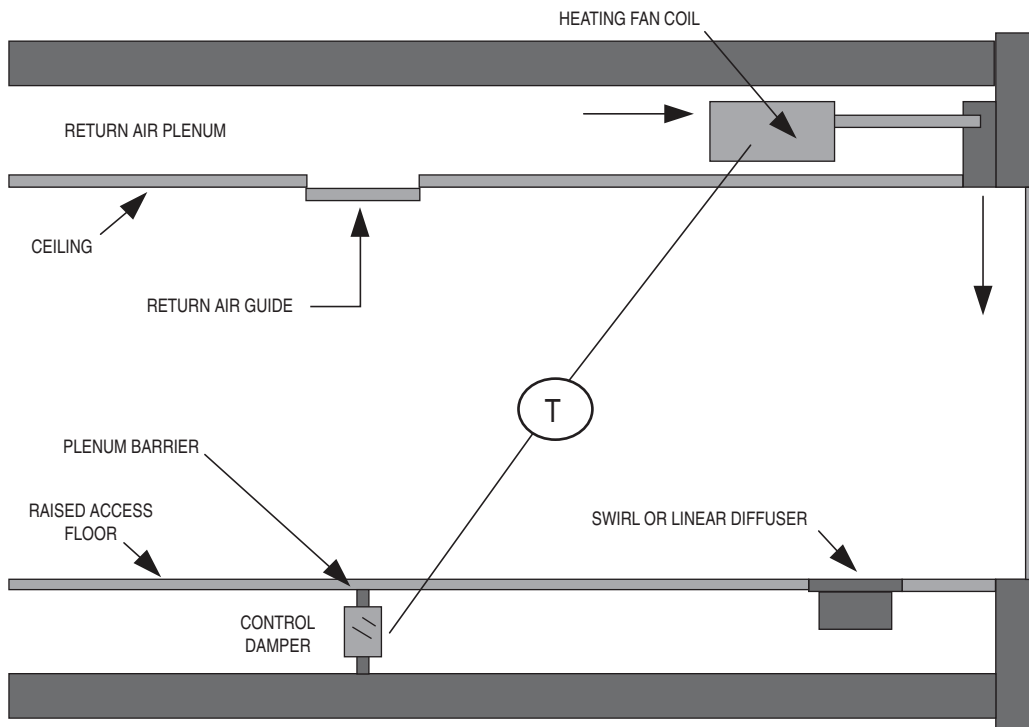

Figure 11:
Overhead fan coils

VAV or Fan Powered VAV Terminal Units

VAV or Fan Powered VAV Terminal Units can also be used for perimeter air distribution. Nailor's 38S units fit nicely between the floor pedestals and provide a variety of airflow ranges to satisfy any job requirement. Care must be taken in design to address noise issues with this equipment because the discharge fan noise may be exposed directly to the room with very little attenuation.

VAV terminal units can be arranged for either constant volume air delivery or VAV delivery. Obviously, the VAV option is much more energy efficient. Primary air can be taken directly from the underfloor plenum or it can be ducted from above the floor in a heating mode. Some typical layouts are shown in figures 9,10, and 12.

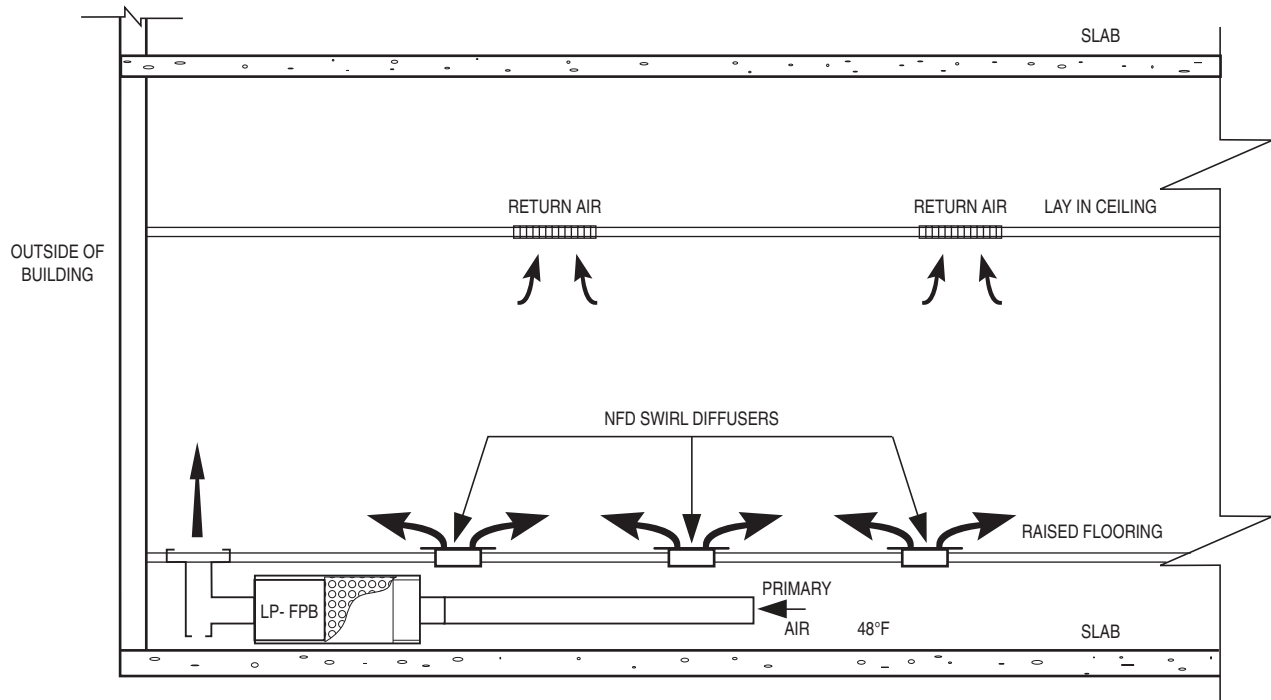

Figure 12:
Underfloor ducted fan powered VAV terminal unit

Fan powered VAV terminal units can also be employed above the ceiling in the perimeter zone. In cases of high envelope loads, the underfloor air may not be adequate to remove the perimeter heat. Using 55°F. (13°C.) or cooler air in the fan powered VAV terminal unit may be the only

option in these circumstances. Primary air is ducted to the units and heat is supplied by the supplemental heaters, either electric or hot water, locally at the terminal units. See Figure 13.

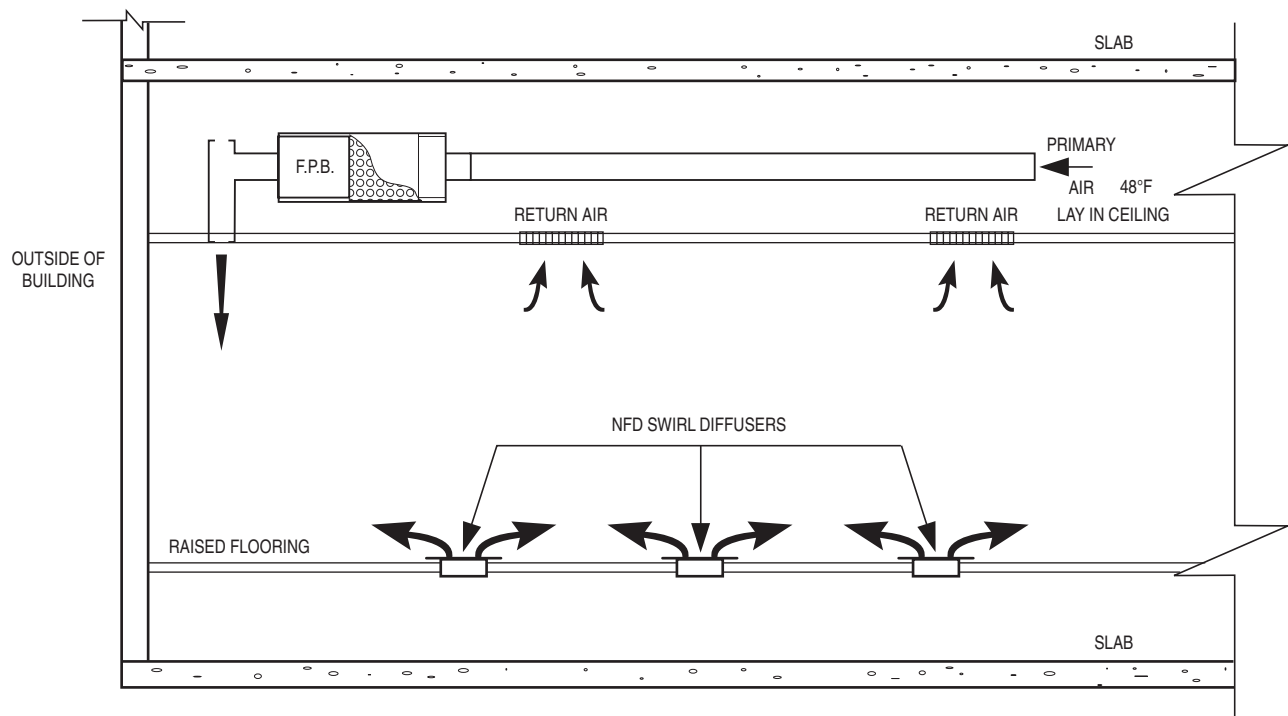

Figure 13:
Fan powered VAV terminal unit in ceiling

Conference Rooms

Conference rooms, training rooms and any other areas that are enclosed and subject to varying heat loads are usually designed with their own zone. These heat loads are much more dynamic as compared to an office area. Spaces like these should be served by some form of VAV control.

VAV Fan Coils or Fan Powered Terminal Units

When using a fan powered unit to supply the underfloor operating pressure under a conference or training room,

the room will have to be isolated from the rest of the underfloor plenum by a septum or plenum divider. This septum will have to be sealed to the concrete floor and to the underside of the tiles that make up the raised floor. The fan powered unit is configured to pressurize the isolated plenum as shown in Figure 14. The VAV fan powered unit is equipped with an ECM motor for large turn down to handle large variations in loads. The motor controller will be controlled by a thermostat in the room and have at least P+I functionality to maintain efficacy of control and comfort in the space.

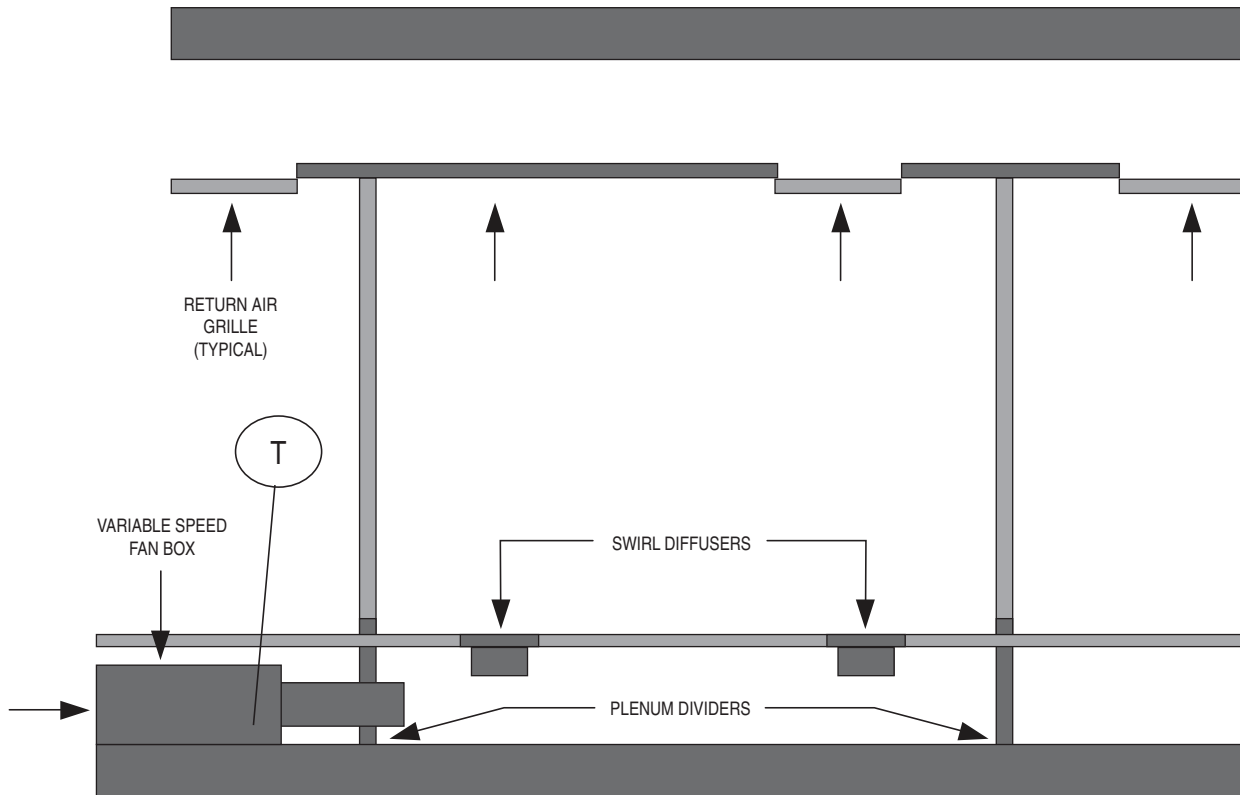

Figure 14:
Variable-speed fan terminal serving conference room.

VAV Diffusers

Another way to maintain room comfort with varying loads is to equip the room with VAV floor diffusers. Modulating diffusers can allow air from the primary plenum to increase or decrease to satisfy room demand. For conference rooms and training areas, the typical density of floor diffusers per square foot of space should be increased by at least 50% in order to provide for heavy heat loads during times of high occupancy. VAV diffusers have modulating actuators rather than 3 point floating devices to keep all the actuators in one zone synchronized.

Actuators with 3 point floating control will become lost during the day and have to be recalibrated or zeroed regularly. The built-in actuator will be controlled by a thermostat in the room and have at least P+I functionality to maintain efficacy of control and comfort in the space.

Cost Issues

Addition of Raised Floor System		Further Addition of UFAD System	
Typical Cost Adds	Typical Cost Reductions	Typical Cost Adds	Typical Cost Reductions
Basic Structure Costs: <ul style="list-style-type: none"> Increased column size to support floor Mechanical cores must either be raised or (handicapped) ramping installed Slab-to-slab height increase if space floor-to-ceiling height is to be maintained Cost of the raised floor and premium for carpet tiles (vs. rolled carpet) 	Basic Structure Costs: <ul style="list-style-type: none"> No final slab leveling as floor is laser leveled 	Basic Structure Costs: <ul style="list-style-type: none"> Slab must be cleaned (and treated with an antimicrobial agent) prior to floor installation 	Basic Structure Costs: <ul style="list-style-type: none"> Slab-to-slab height may be reduced as HVAC equipment and ductwork is removed from the ceiling plenum Removal of HVAC Equipment from overhead plenum may eliminate need for false ceiling.
Power/Voice/Data Service Costs:	Power/Voice/Data Service Costs: <ul style="list-style-type: none"> Power wiring uses "homerun" power modules throughout the space to reduce cabling requirements Floor outlet boxes in each workstation eliminate the need to electrify furniture Modular plugs in outlet boxes reduce the required connection time for PVD services Installation costs are reduced due to the ease of working at floor level Conduit costs may be significantly reduced or eliminated if plenum rated cable is used 	Power/Voice/Data Service Costs:	Power/Voice/Data Service Costs:
HVAC System Costs:	HVAC System Costs:	HVAC System Costs: <ul style="list-style-type: none"> Thorough sealing of components/surfaces that compose the underfloor supply plenum Addition of ducts or air highways to ensure proper delivery of the conditioned air through the underfloor plenum Higher diffuser cost due to increased quantity and relatively higher cost (\$/cfm) of the outlets Additional smoke detectors for underfloor plenum Special air handlers with bypass 	HVAC System Costs: <ul style="list-style-type: none"> Reduction (or elimination) of horizontal (branch) ductwork feeding terminal units Reduction of (rectangular and flexible) discharge ductwork and dampers Reduction of required thermal insulation as supply air passes through an already conditioned plenum Reduced outlet balancing requirements as most diffusers allow occupant adjustment Elimination of radiation dampers on supply outlets Reduction in the number of required terminal units (especially in interior zones) Reduced number of space thermostats and associated wiring as the number of terminal units are reduced Potential reduction in return outlets if false ceiling is eliminated

Continued on Page F18

....Continued

Addition of Raised Floor System		Further Addition of UFAD System (cont'd)	
Typical Cost Adds	Typical Cost Reductions	Typical Cost Adds	Typical Cost Reductions
HVAC System Costs:	HVAC System Costs:	HVAC System Costs:	HVAC System Costs: <ul style="list-style-type: none"> • Reduced installation costs as work is done at floor level • Possible reduction in air handling unit size and capacity (where design airflow quantity can be reduced)

Table 2a:
Cost Considerations for the Addition of Raised Floor and UFAD Systems: First Costs

F

ENGINEERING GUIDE AND INDEX

Addition of Raised Floor System		Further Addition of UFAD System	
Typical Cost Adds	Typical Cost Reductions	Typical Cost Adds	Typical Cost Reductions
Utility Costs:	Utility Costs:	Utility Costs:	Utility Costs: <ul style="list-style-type: none"> • Reduced fan operational cost due to lower fan static pressures • Possible refrigeration plant operational cost savings due to increased chiller efficiency using warmer return water • Extended economizer cycle operation due to higher supply/return air temperatures
Maintenance/Operation Costs:	Maintenance/Operation Costs: <ul style="list-style-type: none"> • Reduced carpet replacement costs resulting from use of replaceable carpet tiles • Reduction of workstation relocation and/or service reconfiguration costs due to modular cabling and easily movable PVD service boxes 	Maintenance/Operation Costs:	Maintenance/Operation Costs: <ul style="list-style-type: none"> • Reduced failures of control components due to reduction of terminal units • Reduced calls to maintenance regarding comfort complaints due to increased level of individual control
Cash Flow Related Intangibles:	Cash Flow Related Intangibles: <ul style="list-style-type: none"> • Possible accelerated depreciation on access floor and carpet (non-fixed assets) 	Cash Flow Related Intangibles:	Cash Flow Related Intangibles: <ul style="list-style-type: none"> • Possible reduction in installation time of HVAC system reduces total construction time and enables earlier occupancy

Table 2b:
Cost Considerations for the Addition of Raised Floor and UFAD Systems: Life Cycle Costs

Standards, Codes and Ratings

ANSI/ASHRAE Standard 55-1992

UFAD systems usually involve some room stratification and greater temperature variations that are allowed in Standard 55-1992. The latest version, 1992, also allows for variances with individual control of the diffusers. While this can be used in Task Ambient systems, UFAD systems do not conform to Standard 55 allowable conditions as it is written today. There are efforts underway to update Standard 55-1992 to include UFAD designs.

ANSI/ASHRAE Standard 62-2001

Standard 62 provides guidelines for the determination of ventilation rates that will maintain acceptable indoor air quality. Currently, ventilation rates are adjustable based on the ventilation effectiveness E_v of the air distribution system. Displacement ventilation systems can actually provide ventilation effectiveness rates above 100%. UFAD systems are not explicitly addressed in Standard 62 at this time, although more definitive research is being promoted at ASHRAE to better define E_v for UFAD systems. E_v for UFAD systems is generally believed to be between 1.0 and 1.2.

Standard 62 requires minimum ventilation rates for different types of spaces. Some method of determining and insuring minimum ventilation rates must be provided in the design.

ANSI/ASHRAE/IESNA Standard 90.1-2001

There is potential conflicts under 90.1 concerning simultaneous heating and cooling to a common zone. In some designs where all occupants have individual control over their thermostats, it is possible for two individuals to set their respective thermostats such that one requires heating and the other cooling in the same zone. There are exceptions to the requirements of paragraph 9.5.2 in 90.1, and studying the subtle differences in operation between UFAD and overhead systems, may allow compliance for the UFAD design.

ANSI/ASHRAE Standard 113-1990

This is the only standard available for determining the air diffusion performance of a diffuser, and it is not applicable to underfloor systems. Current research is being sought to add procedures to the standard that will address UFAD systems.

ASHRAE Standard 129-1997

This is a test method for evaluating or rating an air distribution system's ability to provide ventilation air to a specific space in a building. Results from this test may be used to determine compliance with ASHRAE 62. Results for UFAD systems should allow credits that lead to reduced outdoor air requirements.

Title 24

Title 24 mandates off hour controls for central HVAC systems and stipulates that the largest zone that can be controlled in isolation is 25,000 square feet (2,300 m²). Buildings with floor plates larger than this will have to be subdivided. Local fire codes may require even smaller zones.

Title 24 requires that zones with heating/cooling changeover designs have airflow reduced to 30% of peak before heating can commence. This means that perimeter zones served by fan powered units will have to require the fan powered units to modulate down to the 30% level before the heater can be energized. In perimeter zones that use some sort of baseboard heaters where the underfloor air is supplied by swirl diffusers, this may not be possible.

Title 24 prohibits electric heat; however, credits allowed under the improved chiller efficiency or enhanced airside economizer operation may allow its use.

Title 24 requires thermostatic controls with adjustable set points. Care should be taken in placing the thermostats to place them in representative locations. Because of the designed room stratification, typical locations may not be reasonable.

NFPA 90A

Paragraph 2-3.6.3.1 requires that diffusers that are mounted in the floor must have a dust basket supplied with the diffuser. For linear or bar diffusers located in perimeter plenums, an alternate means of dust collection must be provided since they do not come with dirt baskets. Furthermore diffusers must be supplied with a screen or grille that will not allow a 1/2" (1.3 cm) ball to pass through them.

Paragraph 2-3.6.2 and 2-3.7.2 state that diffusers "Shall be constructed of a non-combustible material or a material that has a maximum flame spread index of 25 and a maximum smoke developed index of 50."

Today, there are some manufacturers who advertise fire-rated plastic diffusers. They fall in 3 categories: fire-rated plastic parts, non-fire-rated plastic parts protected by a metal enclosure, and fire-rated metal parts. The fire-rated plastics tend to be more brittle than the original non-fire-rated parts. The brittleness degrades the structural integrity of the diffuser, but more importantly, causes the mounting rings to break easily. Until and unless more plastic, less brittle, fire-rated plastics are developed, these should be avoided for use in floors where people may walk or sit. The non-fire-rated plastic diffusers with metal enclosures can be very difficult to install. The enclosures have to be mounted to the bottom of the floor tiles. These are normally irregular surfaces and sealing poses a great problem. Nailor Industries is the only manufacturer of cast aluminum, fully fire-rated floor diffuser parts for easy installation and safe sturdy operation. Hence, only metal diffusers are truly acceptable for underfloor applications unless the local authority having jurisdiction over the fire codes specifically approves the plastic non-fire rated diffusers.

Uniform Building and Other Applicable Codes

Local fire codes may limit the size of a common underfloor plenum without smoke barriers. Sometimes they can be as small as 3000 ft² (280 m²) or limited in width to 30 ft. (9 m).

Typically, underfloor plenums contain very low levels of combustible materials; however, some local codes require plenums under 18" (45 cm) to be sprinkled. Nearly all local codes require plenums over 18" (45 cm) to be sprinkled.

LEED

UFAD systems may garner LEED points in two categories: Energy and Atmosphere and Indoor Environmental Quality. Under Energy and Atmosphere, Credit 1 allows points for optimizing the energy performance of a building. Under Indoor Environmental Quality, Credit 2 allows points for Ev in excess of 0.9.

Design Issues

Floor Heights

There may be opportunities for lowering floor heights. Ceiling requirements should be reviewed carefully. If ceilings are eliminated, lighting and noise issues should be evaluated.

Underfloor Plenum Heights

Underfloor plenum heights are usually determined by the height of the largest equipment that must be fitted under the raised floor.

Space Cooling and Heating Loads

Loads are calculated just as they are with overhead systems. Attention must be paid to how successfully the floor diffusers will stratify the air in the occupied zone. Floor diffusers with high vertical projections are not going to effectively set up the required thermocline in the room. This in turn will require that enough airflow be supplied to the zone to mix the entire room. Floor diffusers such as Nailor's swirl diffusers will establish a thermocline at the lowest allowable level and reduce airflow requirements into the room to similar levels as used in traditional overhead systems.

The resultant lower airflow requirement is the result of the stratification above the occupied zone and the divergence of the room load from the total equipment load. Since air is rising as it warms in the homogeneous occupied zone, much of the heat is being moved out of the room from the stratified unoccupied zone without affecting the actual room load. Heat gains in the unoccupied zone are not room loads. See figure 4 and Table 3 for a guide to radiant and convective heating splits.

Heat Source	Radiant Portion [%]	Convective Portion [%]
Transmitted solar, no inside shade	100	0
Window solar, with inside shade	63	37
Absorbed (by fenestration) solar	63	37
Fluorescent lights, suspended, unvented	67	33
Fluorescent lights, recessed, vented to return air	59	41
Fluorescent lights, recessed, vented to return air and supply air	19	81
Incandescent lights	80	20
People, moderate office work	38	62
Conduction, exterior walls	63	37
Conduction, exterior roof	84	16
Infiltration and ventilation	0	100
Machinery and appliances	20 to 80	80 to 20

Table 3:
Radiant/Convective Splits for Typical Office Heat Sources

Space heating is normally only needed near the perimeter of the building where the heat loss to the outside of the building needs to be offset. Sometimes top floors during periods of low occupancy like at night or weekends will need a small amount of heating also. Load calculations for heating are the same as for overhead heating. If return air can be injected into the perimeter zone for heating use, system efficiency can be greatly improved.

The building envelope has the largest loads in the building since they are affected by rapid climate fluctuations and excursions to peaks for extended periods. The purposes of the perimeter system are to neutralize the skin loads, provide heating and cooling as needed, and provide automatic control to allow quick response to potentially rapid load changes. Neutralizing the skin loading allows the isolation of the perimeter zone from the interior zone. Perimeter zones are normally 15 feet or less in depth. Some are as thin as two feet depending on air distribution design.

Locations of Floor Diffusers

Swirl diffusers are typically used in the interior zone. The flexibility of locating the swirl diffusers in the common underfloor plenum is a big plus to UFAD systems. The diffusers can be located in close proximity to the space loads with ease. Typically, one diffuser is located in each cubicle allowing direct adjustment by the occupant. In non divided areas, one diffuser in every 80 to 110 square feet is normally adequate for typical office loads. Conference and training rooms will usually require an increase in diffusers to one for each 50 to 75 square feet.

Perimeter zones are usually served by linear bar grilles. These grilles provide a smooth curtain of air that can sweep up the wall and help to isolate the skin loads on the building. Care must be taken to limit the throw on these devices to 5 to 8 feet. Longer throws will curl back into the room in heating modes and disturb the thermocline in the interior zones.

Useful Formulas and Definitions

Airflow

$$Q = V \times A$$

$$Q = \text{Airflow Rate, cfm (l/s)}$$

$$V = \text{Velocity, fpm (m/s)}$$

$$A = \text{Area, ft}^2 \text{ (m}^2\text{)}$$

Pressure

<i>Imperial Units</i>	<i>Metric Units</i>
$VP = \left(\frac{V \text{ (fpm)}}{4005} \right)^2$	$VP \text{ (Pa)} = \left(\frac{V \text{ (m/s)}}{1.3} \right)^2$

VP = Velocity Pressure

TP = SP + VP

TP = Total Pressure, " w.g. (Pa)

SP = Static Pressure, " w.g. (Pa)

Heat Transfer

<i>Imperial Units</i>	<i>Metric Units</i>
$H = 1.085 \times \text{cfm} \times \Delta t \text{ (}^\circ\text{F)}$	$H = 1.23 \times \text{l/s} \times \Delta t \text{ (}^\circ\text{C)}$
$H = \text{Heat Transfer, Btu's/hr.}$	$H = \text{Heat Transfer, watts}$
Btu = British Thermal Unit	
$\Delta t = \text{Temp. Differential}$	

Water Coils

<i>Imperial Units</i>	<i>Metric Units</i>
$\Delta t \text{ (}^\circ\text{F)} = 927 \times \frac{\text{Mbh}}{\text{cfm}}$	$\Delta t \text{ (}^\circ\text{C)} = 829 \times \frac{\text{kW}}{\text{l/s}}$
$\Delta t = \text{Air Temperature Rise}$	
Mbh = 1000's of Btu's/hr.	
$\Delta t \text{ (}^\circ\text{F)} = 2.04 \times \frac{\text{Mbh}}{\text{GPM}}$	$\Delta t \text{ (}^\circ\text{C)} = 0.244 \times \frac{\text{kW}}{\text{l/s}}$

$\Delta t = \text{Water Temperature Drop}$

GPM = Water Flow, gallons per minute

l/s = Liters per second

Electric Coils

$$\Delta t \text{ (}^\circ\text{F)} = \frac{\text{kW} \times 3160}{\text{cfm}}$$

$$\text{kW} = \frac{\text{cfm} \times \Delta t}{3160}$$

$\Delta t = \text{Air Temperature Rise}$

kW = Kilowatts

Power DC Circuits

$$\text{hp} = \frac{E \times I \times \text{Eff.}}{746}$$

$$W = E \times I$$

$$\text{Eff.} = \frac{746 \times \text{bhp}}{W}$$

Power AC Circuits (Single Phase)

$$\text{PF} = \frac{W}{E \times I}$$

$$I = \frac{746 \times \text{hp}}{E \times \text{Eff.} \times \text{PF}}$$

$$\text{Eff.} = \frac{746 \times \text{hp}}{E \times I \times \text{PF}}$$

$$\text{kW} = \frac{E \times I \times \text{PF} \times \text{Eff.}}{1000}$$

$$\text{hp} = \frac{E \times I \times \text{PF} \times \text{Eff.}}{746}$$

$$\text{kVA} = \frac{I \times E}{1000}$$

Power AC Circuits (Three Phase)

$$\text{PF} = \frac{W}{E \times I \times 1.732}$$

$$I = \frac{746 \times \text{hp}}{1.732 \times E \times \text{PF} \times \text{Eff.}}$$

$$\text{Eff.} = \frac{746 \times \text{hp}}{E \times I \times \text{PF} \times 1.732}$$

$$\text{kW} = \frac{E \times I \times \text{PF} \times 1.732}{1000}$$

$$\text{hp} = \frac{E \times I \times 1.732 \times \text{PF} \times \text{Eff.}}{746}$$

$$\text{kVA} = \frac{1.732 \times I \times E}{1000}$$

PF = Power Factor

W = Watts

E = Volts

I = Amperes

hp = Horsepower

Eff. = Efficiency

Imperial/Metric Guide Conversion Factors

Quantity	Imperial Unit	Metric Unit	From Imperial To Metric Multiply By:	From Metric To Imperial Multiply By:
Area	square foot	square meter (m ²)	0.0929	10.764
	square inch	square millimeter (mm ²)	645.16	.00155
Density	pounds per cubic foot	kilograms per cubic meter (kg/M ³)	16.018	.0624
Energy	British thermal unit (BTU)	joule (J)	1055.056	.000948
	kilowatt hour	megajoule (MJ)	3.6	.2778
	watts per second	joule (J)	1.0	1.0
	horsepower hour	megajoule (MJ)	2.6845	.3725
Force	ounce force	newton (N)	.278	3.597
	pound force	newton (N)	4.4482	.2248
	kilogram force	newton (N)	9.8067	.102
Heat	BTU per hour	watt (W)	.2931	3.412
	BTU per pound	joules per kilogram (J/kg)	2326.0	.00043
Length	inch	millimeter (mm)	25.4	.0394
	foot	millimeter (mm)	304.8	.00328
	foot	meter (m)	.3048	3.2808
	yard	meter (m)	.9144	1.0936
Mass (weight)	ounce (avoirdupois)	gram (g)	28.350	.0353
	pound (avoirdupois)	kilogram (kg)	.4536	2.2046
Power	horsepower	kilowatt (kW)	.7457	1.341
	horsepower (boiler)	kilowatt (kW)	9.8095	.1019
	foot pound - force per minute	watt (W)	.0226	44.254
	ton of refrigeration	kilowatt (kW)	3.517	.2843
Pressure	inch of water column	kilopascal (kPa)	.2486	4.0219
	foot of water column	kilopascal (kPa)	2.9837	.3352
	inch of mercury column	kilopascal (kPa)	3.3741	.2964
	ounces per square inch	kilopascal (kPa)	.4309	2.3206
	pounds per square inch	kilopascal (kPa)	6.8948	.145
Temperature	Fahrenheit	Celsius (°C)	5/9(°F-32)	(9/5°C)+32
Torque	ounce - force inch	millinewton-meter (mN.m)	7.0616	.1416
	pound - force inch	newton-meter (N.m)	.1130	8.8495
	pound - force foot	newton-meter (N.m)	1.3558	.7376
Velocity	feet per second	meters per second (m/s)	.3048	3.2808
	feet per minute	meters per second (m/s)	.00508	196.85
	miles per hour	meters per second (m/s)	.44704	2.2369
Volume (capacity)	cubic foot	liter (l)	28.3168	.03531
	cubic inch	cubic centimeter (cm ³)	16.3871	.06102
	cubic yard	cubic meter (m ³)	.7646	1.308
	gallon (U.S.)	liter (l)	3.785	.2642
	gallon (imperial)	liter (l)	4.546	.2120
Volume (flow)	cubic feet per minute (cfm)	liters per second (l/s)	.4719	2.119
	cubic feet per minute (cfm)	cubic meters per second (m ³ /s)	.0004719	2119.0
	cubic feet per hour (cfh)	milliliters per second (ml/s)	7.8658	.127133
	gallons per minute (U.S.)	liters per second (l/s)	.06309	15.850
	gallons per minute (imperial)	liters per second (l/s)	0.7577	13.198

Pressure Measurement

Concepts of Pressure. Pressure is force per unit area. This may also be defined as energy per unit volume of fluid. There are three categories of pressure — Total Pressure, Static Pressure and Velocity Pressure. They are all associated with air handling. Unit of pressure is expressed in inches of water, designated **in. w.g.**

Static Pressure is the normal force per unit area at a small hole in the wall of a duct or other boundaries. It is a function of air density and degree of compression. It may be thought of as the pressure in a tire or in a balloon which extends in all directions.

Velocity Pressure is the force per unit area capable of causing an equivalent velocity in moving air. Velocity pressure is a function of air density and velocity. At standard air density, the relationship between velocity pressure and velocity is expressed in the following formula:

$$P_v = \left(\frac{V}{4005} \right)^2 \text{ or } V = 4005 \sqrt{P_v}$$

Where: V = Air Velocity (FPM)
 P_v = Velocity Pressure (in. w.g.)

Total Pressure, as its name implies, is the sum of static pressure and velocity pressure.

The Pitot Static Tube is an instrument used to measure pressure and velocities as illustrated below. It is constructed of two tubes. The inner, or impact tube, senses the total pressure as the impact opening faces upstream. The outer tube senses only the static pressure, which communicates with the airstream through small holes in its wall.

The U-Tube Manometer connects both parts of the Pitot Static Tube. The manometer functions as a subtracting device to give a reading of velocity pressure.

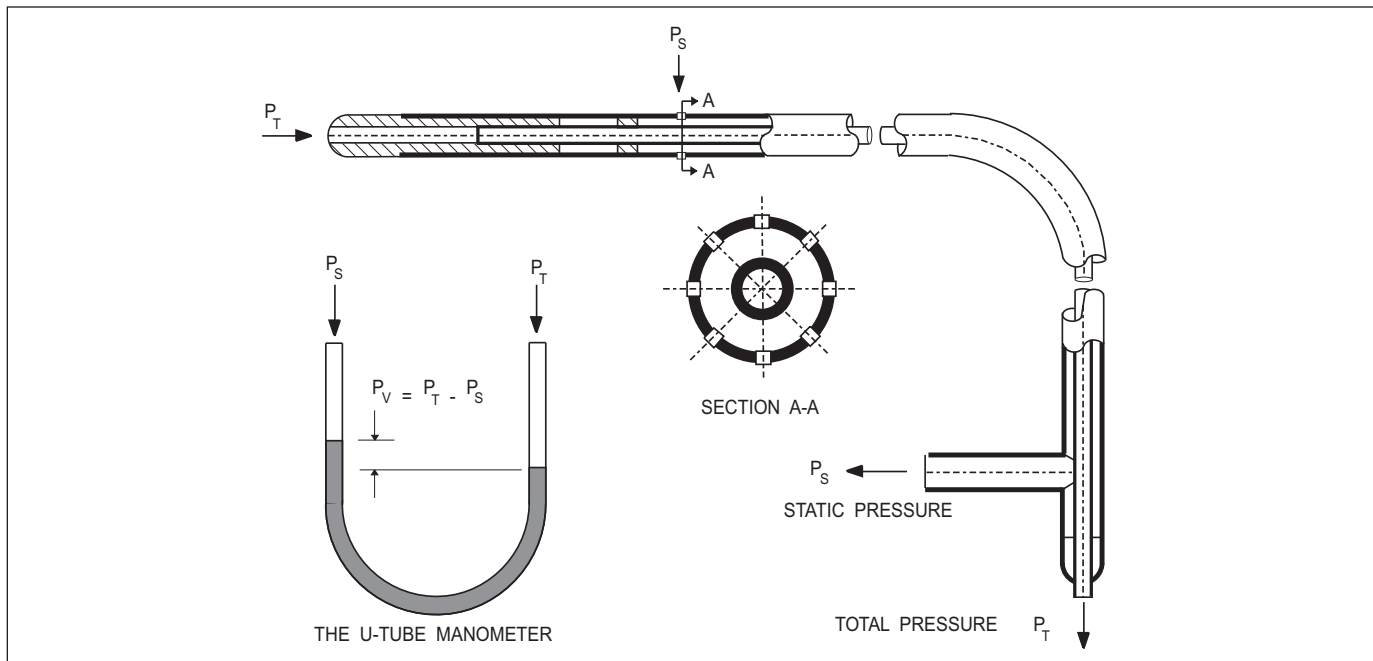

**CONVERSION CHART for converting VELOCITY PRESSURE
in inches of water to VELOCITY in feet per minute**

Note: This chart is based upon standard air conditions of 70° Fahrenheit and 29.92 inches of mercury (barometric pressure), and assumes that the airflow is essentially non-compressible (under 10 inches of water pressure); as reflected by the following formula.

$$\text{Velocity (fpm)} = 4005 \sqrt{\text{Velocity Pressure in inches of water}}$$

.001"	127	.062"	996	.123"	1404	.184"	1718	.245"	1982	.306"	2215	.367"	2426	.77"	3514	1.38"	4705	1.99"	5651	2.60"	6458
.002"	179	.063"	1004	.124"	1410	.185"	1723	.246"	1987	.307"	2219	.368"	2429	.78"	3537	1.39"	4722	2.00"	5664	2.61"	6470
.003"	219	.064"	1012	.125"	1416	.186"	1727	.247"	1991	.308"	2223	.369"	2433	.79"	3560	1.40"	4739	2.01"	5678	2.62"	6482
.004"	253	.065"	1020	.126"	1422	.187"	1732	.248"	1995	.309"	2226	.370"	2436	.80"	3582	1.41"	4756	2.02"	5692	2.63"	6495
.005"	283	.066"	1029	.127"	1427	.188"	1737	.249"	1999	.310"	2230	.371"	2439	.81"	3604	1.42"	4773	2.03"	5706	2.64"	6507
.006"	310	.067"	1037	.128"	1433	.189"	1741	.250"	2003	.311"	2233	.372"	2443	.82"	3625	1.43"	4790	2.04"	5720	2.65"	6519
.007"	335	.068"	1045	.129"	1439	.190"	1746	.251"	2007	.312"	2236	.373"	2445	.83"	3657	1.44"	4806	2.05"	5734	2.66"	6532
.008"	358	.069"	1052	.130"	1444	.191"	1750	.252"	2011	.313"	2239	.374"	2449	.84"	3669	1.45"	4823	2.06"	5748	2.67"	6544
.009"	380	.070"	1060	.131"	1449	.192"	1755	.253"	2015	.314"	2242	.375"	2453	.85"	3690	1.46"	4840	2.07"	5762	2.68"	6556
.010"	400	.071"	1067	.132"	1455	.193"	1759	.254"	2019	.315"	2245	.376"	2456	.86"	3709	1.47"	4856	2.08"	5776	2.69"	6569
.011"	420	.072"	1075	.133"	1461	.194"	1764	.255"	2023	.316"	2248	.377"	2459	.87"	3729	1.48"	4873	2.09"	5790	2.70"	6581
.012"	439	.073"	1082	.134"	1466	.195"	1768	.256"	2027	.317"	2251	.378"	2462	.88"	3758	1.49"	4889	2.10"	5804	2.71"	6593
.013"	457	.074"	1089	.135"	1471	.196"	1773	.257"	2031	.318"	2254	.379"	2466	.89"	3779	1.50"	4905	2.11"	5817	2.72"	6605
.014"	474	.075"	1097	.136"	1477	.197"	1777	.258"	2035	.319"	2257	.380"	2469	.90"	3800	1.51"	4921	2.12"	5831	2.73"	6617
.015"	491	.076"	1104	.137"	1482	.198"	1782	.259"	2039	.320"	2260	.381"	2472	.91"	3821	1.52"	4938	2.13"	5845	2.74"	6629
.016"	507	.077"	1111	.138"	1488	.199"	1787	.260"	2042	.321"	2264	.382"	2475	.92"	3842	1.53"	4954	2.14"	5859	2.75"	6641
.017"	522	.078"	1119	.139"	1493	.200"	1791	.261"	2046	.322"	2268	.383"	2479	.93"	3863	1.54"	4970	2.15"	5872	2.76"	6654
.018"	537	.079"	1125	.140"	1498	.201"	1795	.262"	2050	.323"	2272	.384"	2481	.94"	3884	1.55"	4986	2.16"	5886	2.77"	6666
.019"	552	.080"	1133	.141"	1504	.202"	1800	.263"	2054	.324"	2276	.385"	2485	.95"	3904	1.56"	5002	2.17"	5899	2.78"	6678
.020"	566	.081"	1140	.142"	1509	.203"	1804	.264"	2058	.325"	2280	.386"	2488	.96"	3924	1.57"	5018	2.18"	5913	2.79"	6690
.021"	580	.082"	1147	.143"	1515	.204"	1809	.265"	2062	.326"	2284	.387"	2491	.97"	3945	1.58"	5034	2.19"	5927	2.80"	6702
.022"	594	.083"	1154	.144"	1520	.205"	1813	.266"	2066	.327"	2289	.388"	2495	.98"	3965	1.59"	5050	2.20"	5940	2.81"	6714
.023"	607	.084"	1161	.145"	1525	.206"	1818	.267"	2070	.328"	2293	.389"	2499	.99"	3985	1.60"	5066	2.21"	5954	2.82"	6725
.024"	620	.085"	1167	.146"	1530	.207"	1822	.268"	2074	.329"	2297	.390"	2501	1.00"	4005	1.61"	5082	2.22"	5967	2.83"	6737
.025"	633	.086"	1175	.147"	1536	.208"	1827	.269"	2078	.330"	2301	.40"	2533	1.01"	4025	1.62"	5098	2.23"	5981	2.84"	6749
.026"	645	.087"	1181	.148"	1541	.209"	1831	.270"	2081	.331"	2304	.41"	2563	1.02"	4045	1.63"	5114	2.24"	5994	2.85"	6761
.027"	658	.088"	1188	.149"	1546	.210"	1835	.271"	2085	.332"	2308	.42"	2595	1.03"	4064	1.64"	5129	2.25"	6008	2.86"	6773
.028"	670	.089"	1193	.150"	1551	.211"	1839	.272"	2089	.333"	2311	.43"	2626	1.04"	4084	1.65"	5144	2.26"	6021	2.87"	6785
.029"	682	.090"	1201	.151"	1556	.212"	1844	.273"	2093	.334"	2315	.44"	2656	1.05"	4103	1.66"	5160	2.27"	6034	2.88"	6797
.030"	694	.091"	1208	.152"	1561	.213"	1848	.274"	2097	.335"	2318	.45"	2687	1.06"	4123	1.67"	5175	2.28"	6047	2.89"	6809
.031"	705	.092"	1215	.153"	1567	.214"	1853	.275"	2101	.336"	2322	.46"	2716	1.07"	4142	1.68"	5191	2.29"	6060	2.90"	6820
.032"	716	.093"	1222	.154"	1572	.215"	1857	.276"	2105	.337"	2325	.47"	2746	1.08"	4162	1.69"	5206	2.30"	6074	2.91"	6832
.033"	727	.094"	1228	.155"	1577	.216"	1862	.277"	2119	.338"	2329	.48"	2775	1.09"	4181	1.70"	5222	2.31"	6087	2.92"	6844
.034"	738	.095"	1234	.156"	1582	.217"	1866	.278"	2113	.339"	2332	.49"	2804	1.10"	4200	1.71"	5237	2.32"	6100	2.93"	6855
.035"	749	.096"	1241	.157"	1587	.218"	1870	.279"	2116	.340"	2335	.50"	2832	1.11"	4219	1.72"	5253	2.33"	6113	2.94"	6867
.036"	759	.097"	1247	.158"	1592	.219"	1875	.280"	2119	.341"	2338	.51"	2860	1.12"	4238	1.73"	5268	2.34"	6126	2.95"	6879
.037"	770	.098"	1254	.159"	1597	.220"	1879	.281"	2123	.342"	2342	.52"	2888	1.13"	4257	1.74"	5283	2.35"	6139	2.96"	6890
.038"	780	.099"	1260	.160"	1602	.221"	1883	.282"	2127	.343"	2345	.53"	2916	1.14"	4276	1.75"	5298	2.36"	6152	2.97"	6902
.039"	791	.100"	1266	.161"	1607	.222"	1887	.283"	2131	.344"	2349	.54"	2943	1.15"	4295	1.76"	5313	2.37"	6165	2.98"	6913
.040"	801	.101"	1273	.162"	1612	.223"	1892	.284"	2135	.345"	2352	.55"	2970	1.16"	4314	1.77"	5328	2.38"	6179	2.99"	6925
.041"	811	.102"	1279	.163"	1617	.224"	1896	.285"	2139	.346"	2356	.56"	2997	1.17"	4332	1.78"	5343	2.39"	6191	3.00"	6937
.042"	821	.103"	1285	.164"	1622	.225"	1900	.286"	2143	.347"	2360	.57"	3024	1.18"	4350	1.79"	5359	2.40"	6204	3.01"	6948
.043"	831	.104"	1292	.165"	1627	.226"	1905	.287"	2147	.348"	2363	.58"	3050	1.19"	4368	1.80"	5374	2.41"	6217	3.02"	6960
.044"	840	.105"	1298	.166"	1632	.227"	1909	.288"	2151	.349"	2366	.59"	3076	1.20"	4386	1.81"	5388	2.42"	6230	3.03"	6971
.045"	849	.106"	1304	.167"	1637	.228"	1913	.289"	2154	.350"	2369	.60"	3102	1.21"	4405	1.82"	5403	2.43"	6243	3.04"	6983
.046"	859	.107"	1310	.168"	1642	.229"	1917	.290"	2157	.351"	2372	.61"	3127	1.22"	4423	1.83"	5418	2.44"	6256	3.05"	6994
.047"	868	.108"	1316	.169"	1646	.230"	1921	.291"	2161	.352"	2376	.62"	3153	1.23"	4442	1.84"	5433	2.45"	6269	3.06"	7006
.048"	877	.109"	1322	.170"	1651	.231"	1925	.292"	2164	.353"	2379	.63"	3179	1.24"	4460	1.85"	5447	2.46"	6281	3.07"	7017
.049"	887	.110"	1328	.171"	1656	.232"	1929	.293"	2168	.354"	2383	.64"	3204	1.25"	4478	1.86"	5462	2.47"	6294	3.08"	7028
.050"	896	.111"	1334	.172"	1661	.233"	1933	.294"	2171	.355"	2386	.65"	3229	1.26"	4495	1.87"	5477	2.48"	6307	3.09"	7040
.051"	904	.112"	1340	.173"	1666	.234"	1937	.295"	2175	.356"	2389	.66"	3254	1.27"	4513	1.88"	5491	2.49"	6319	3.10"	7051
.052"	913	.113"	1346	.174"	1670	.235"	1941	.296"	2179	.357"	2393	.67"	3279	1.28"	4531	1.89"	5506	2.50"	6332	3.11"	7063
.053"	922	.114"	1352	.175"	1675	.236"	1945	.297"	2182	.358"	2396	.68"	3303	1.29"	4549	1.90"	5521	2.51"	6345	3.12"	7074
.054"	931	.115"	1358	.176"	1680	.237"	1950	.298"	2186	.359"	2400	.69"	3327	1.30"	4566	1.91"	5535	2.52"	6358	3.13"	7085
.055"	939	.116"	1364	.177"	1685	.238"	1954	.299"	2189	.360"	2403	.70"	3351	1.31"	4583	1.92"	5550	2.53"	6370	3.14"	7097
.056"	948	.117"	1370	.178"	1690	.239"	1958	.300"	2193	.361"	2406	.71"	3375	1.32"	4601	1.93"	5564	2.54"	6383	3.15"	7108
.057"	956	.118"	1376	.179"	1695	.240"	1962	.301"	2197	.362"	2410	.72"	3398	1.33"	4619	1.94"	5579	2.55"	6395	3.16"	7119
.058"	964	.119"	1382	.180"	1699	.241"	1966	.302"	2200	.363"	2413	.73"	3422	1.34"	4636	1.95"	5593	2.56"	6408	3.17"	7131
.059"	973	.120"	1387	.181"	1704	.242"	1970	.303"	2204	.364"	2416	.74"	3445	1.35"	4653	1.96"	5608	2.57"	6420	3.18"	7142
.060"	981	.121"	1393	.182"	1709	.243"	1974	.304"	2208	.365"	2420	.75"	3468	1.36"	4671	1.97"	5623	2.58"	6433	3.19"	7153
.061"	989	.122"	1399	.183"	1713	.244"	1978	.305"	2212	.366"	2423	.76"	3491	1.37"	4688	1.98"	5637	2.59"	6445	3.20"	7164

INDEX BY NAILOR MODEL NUMBER

MODEL	DESCRIPTION	PAGE NO.
ANFD	Floor "Swirl" Diffusers • Aluminum - High Performance	B7
ANFD-VAV	VAV Floor "Swirl" Diffusers with Actuator • Aluminum - High Performance	B17
NFA	Floor Access Outlet • Polycarbonate Plastic - Electrical and Communication Cable Outlet	B12
NFD	Floor "Swirl" Diffusers • Polycarbonate Plastic - High Performance	B3
NFD-VAV	VAV Floor "Swirl" Diffusers with Actuator • Polycarbonate Plastic - High Performance	B14
NLD-VC	VAV Linear Floor Diffusers • Rectangular • Cooling Only - Non-Ducted	C3
NLD-VCD	VAV Linear Floor Diffusers with Actuator • Rectangular • Cooling Only - Ducted	C3
NLD-VCHD	VAV Linear Floor Diffusers • Rectangular • Cooling with Ducted Heating	C3
NLD-VH	VAV Linear Floor Diffusers • Rectangular • Heating Only - Non-Ducted	C3
NLD-VHCD	VAV Linear Floor Diffusers • Rectangular • Heating with Ducted Cooling	C3
NLD-VHD	VAV Linear Floor Diffusers • Rectangular • Heating Only - Ducted	C3
NLYD-VC	VAV Linear Floor Diffusers • Square • Cooling Only - Non-Ducted	C10
NLYD-VH	VAV Linear Floor Diffusers • Square • Heating Only - Non-Ducted	C10
38F	Underfloor Fan Coil/Booster Units • ECM Motor • No Heat	E3
38FE	Underfloor Fan Coil/Booster Units • ECM Motor • Electric Heat	E3
38FW	Underfloor Fan Coil/Booster Units • ECM Motor • Hot Water Heat	E3
38FWE	Underfloor Fan Coil/Booster Units • ECM Motor • Hot Water / Electric Heat	E3
38FZ	Underfloor Fan Coil/Booster Units • ECM Motor • Chilled Water	E3
38FZE	Underfloor Fan Coil/Booster Units • ECM Motor • Chilled Water/Electric Heat	E3
38FZW	Underfloor Fan Coil/Booster Units • ECM Motor • Chilled/Hot Water Coil	E3
38FZWE	Underfloor Fan Coil/Booster Units • ECM Motor • Chilled/Hot Water and Electric Heat	E3
38S	Underfloor Fan Powered Terminal Units • Series Flow - Constant Volume • No Heat	D3
38SE	Underfloor Fan Powered Terminal Units • Series Flow - Constant Volume • Electric Heat	D3
38SW	Underfloor Fan Powered Terminal Units • Series Flow - Constant Volume • Hot Water Heat	D3



"Complete Air Control and Distribution Solutions"

International Group Locations:

**International and United States
Headquarters, Sales, Manufacturing,
Research and Development and Test
Laboratory:**

Nailor Industries of Texas Inc.
4714 Winfield Rd.,
Houston, Texas 77039
U.S.A.

Tel: (281) 590-1172
Fax: (281) 590-3086
info@nailor.com
www.nailor.com

**Canadian Headquarters, Sales and
Manufacturing:**

Nailor Industries Inc.
98 Toryork Drive,
Toronto, Ontario M9L 1X6
Canada
Tel: (416) 744-3300
Fax: (416) 744-3360

**European Sales and Marketing
Center, Manufacturing:**

(also responsible for exports to the
Middle East, Asia and Australia):

Advanced Air (UK) Ltd.
Burrell Way,
Thetford, Norfolk
IP24 3WB
England
Tel: (0)1842 765657
Fax: (0)1842 753493
sales@advancedair.co.uk
www.advancedair.co.uk

**Regional Sales and Manufacturing
Facilities:**

Nailor Industries Inc. (Western U.S.A.)
3200 E. Gowan, Suite 105
N. Las Vegas, NV 89030
U.S.A.
Tel: (702) 648-5400
Fax: (702) 638-0400

Nailor Industries (Western) Inc.
Unit F, 4427 - 72nd Avenue S.E.,
Calgary, Alberta T2C 2G5
Canada
Tel: (403) 279-8619
Fax: (403) 279-5035